



ANCHOR FASTENING

Technology manual





Important notices

1. The technical data presented in this Anchor Fastening Technology Manual is based on numerous tests and evaluation criteria according to the current state-of-the-art and the relevant European regulations.
2. For all those anchors holding a European Technical Assessment (ETA), noted in the cover with the respective icon, the technical data given in this manual is based and in accordance with the information given in the respective ETA. Additional Hilti technical data, supplementing the ETA technical data, may be available, in which case, it will be clearly noted on footnotes and/or tables.
3. For all those anchors not holding an ETA, the technical data given in this manual is based on numerous tests and evaluation criteria according to the current state-of-the-art and/or the relevant European applicable regulations for the assessment of fasteners, which is the basis for obtaining an ETA.
4. In addition to the tests for standard service conditions (including, in some cases, seismic as an option), fire resistance, shock and fatigue tests may have been performed – see respective reports for full details.
5. The data and values are based on the respective average values obtained from tests under laboratory or other controlled conditions, or on generally-accepted methodology. It is the responsibility of the customer to use the data given in the light of conditions on site and taking into account the intended use of the products concerned. The customer must check the listed prerequisites and criteria conform with the conditions actually existing on the job-site. Whilst Hilti can give general guidance and advice, the nature of Hilti products means that the ultimate responsibility for selecting the right product for a particular application must lie with the customer.
6. The given technical data in the Anchor Fastening Technology Manual is valid only for the indicated test conditions. Due to variations in local base materials, on-site testing maybe required to determine performance at any specific jobsite.
7. Technical data presented herein was current as of the date of publication (see back cover). Hilti's policy is one of continuous development. We therefore reserve the right to alter technical data and specifications, etc. without notice.
8. Construction materials and conditions vary on different sites. If it is suspected that the base material has insufficient strength to achieve a suitable fastening, contact the Technical Competence Center of your local Hilti organization.
9. All products must be used, handled and applied strictly in accordance with all current instructions for use published by Hilti, i.e. technical instructions, operating manuals, setting instructions, installation manuals and others.
10. All products are supplied and advice is given subject to the local Hilti organization terms of business.
11. While reasonable measures have been taken to provide accurate information, no warranty is provided that it is without error. Hilti shall in no event be obligated for direct, indirect, incidental, consequential, or any other damages, losses or expenses in connection with, or by reason of, the use of, or inability to use, the products or information for any purpose. Implied warranties of merchantability and fitness for a particular purpose are specially excluded.

Hilti Corporation
FL-9494 Schaan
Principality of Liechtenstein
www.hilti.group

Hilti = registred trademark of the Hilti Corporation, Schaan



Table Of Contents

Anchor selector	1
Resistance under fire exposure	9
Selection of corrosion protection for anchors	15
Chemical Anchors	
Concrete	
HIT-RE 500 V3	17
HIT-HY 200-A/R	57
HIT-RE 100	95
HIT-HY 110	123
HIT-HY 100	143
HIT-CT 1	165
HIT-ICE	187
HVU-TZ	201
HVU2	207
Multimaterial	
HIT-HY 170	221
HIT-MM Plus	257
HIT-1 / HIT-1 CE	271
Masonry	
HIT-HY 270	283
Mechanical Anchors	
Undercut Anchor	
HDA	309
HMU-PF	319
HSC-A (R), HSC-I (R)	325
Expansion Anchor	
HSL-3 (R)	335
HST3	349
HST2	359
HSA	369
HSV	377
HSB	381
Screw Anchor	
HUS3	385
HUS-HR / HUS-CR	419
HUS-V	427
HUS 6 / HUS-S 6	431

Flush Anchor	
HKD	437
HKV	451
Plastic Anchors	
HRD	455
HRV	475
HPS-1	481
HUD-1	485
HUD-L	491
HLD	495
HMF	499
GD 14 + GRS 12	503
Light Duty Metal Anchor	
DBZ	507
HK	511
HLC	517
HT	523
HLV	527
HAM	531
HPD	533
HKH	537
HCA	541
HHD-S	545
HSP / HFP	547
HTB	549
Insulation Anchor	
HIF	553
HTH	557
HTR-P / HTR-M	569
T-Save HTS-P / HTS-M	575
IDP	581



Chemical anchor selector

Anchor type		Concrete														
		Hilti HIT-RE 500 V3			Hilti HIT-HY 200 A(R)				Hilti HIT-RE 100		Hilti HIT-HY 110			Hilti HIT-HY 100		
Anchor size		M8-M39	M8-M20	φ8-φ40	M8-M20	M8-M30	M8-M20	φ8-φ32	M8-M30	φ8-φ32	M8-M30	M8-M20	φ8-φ25	M8-M30	M8-M20	φ8-φ25
Base material	Cracked concrete	■	■	■	■	■	■	■	■	■				■		■
	Non-cracked	■	■	■	■	■	■	■	■	■	■	■	■	■	■	■
	Lightweight concrete															
	Aerated concrete															
	Solid brick masonry															
	Hollow brick															
	Drywall															
Approvals	European Technical approval (ETA)	■	■	■	■	■	■	■	■	■	■	■	□	■	■	□
	ETA seismic C1	■	■	■	■	■		■								
	ETA seismic C2	■			■	■										
	Fatigue approval*	■														
	Shock approval*	■	■	■												
	Fire tested	■	■		■	■	■	■								
SafeSet		■	■		■	■	■		■							
Clean-Tec																
Specification	Steel, galvanized	■			■	■	■		■		■	■		■	■	
	Steel, hot dip galvanized					■					■					
	Stainless steel A2															
	Stainless steel A4	■	■		■	■			■		■	■		■	■	
	HCR steel	■				■			■		■			■		
	Rebar B500 B			■				■		■						■
	External thread	■			■	■			■		■			■		
	Internal thread	■	■		■	■	■		■		■	■		■	■	
Setting	Pre-setting	■	■		■	■	■		■		■	■		■	■	
	Through-fastening				■											
Profis		■	■	■	■	■	■	■								







*Local approvals

■ ETA approval only for anchoring in concrete with rebar elements

□ ETA approval only for post-installed rebar applications (according to EC2)

Concrete					Multimaterial								Masonry				
Hilti HIT-CT 1		Hilti HIT-ICE			HVZ	HVU2		Hilti HIT-HY 170				Hilti HIT-MM Plus		Hilti HIT-1	Hilti HIT-HY 270		
M8-M24	φ8-φ25	M8-M24	M8-	φ8-φ25	M10-M20	M8-M30	M8-M20	M8-M24	M8-M16	M8-M12	φ8-φ25	M8-M24	M8-M12	M6-M12	M8-M16	M6-M16	M8-M12
		■			■	■	■	■			□						
■	■	■	■	■	■	■	■	■	■		□	■	■		■		
								■		■		■	■	■	■	■	■
								■		■		■	■	■	■	■	■
■	■				■	■	■	■	■	■	□				■	■	■
					■												
					■												
■	■	■	■		■	■	■	■	■								
■	■																
■		■	■		■	■	■	■	■	■		■	■	■	■	■	■
■		■			■	■	■	■	■	■					■		
	■			■							■						
■		■			■	■	■	■	■	■		■	■		■	■	■
■		■	■		■	■	■	■	■	■		■	■		■	■	■
					■										■		
■	■	■	■	■	■	■	■										



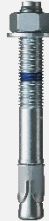



Mechanical anchor selector

Anchor type		Undercut anchors			Expansion anchors			
		HDA	HMU-PF	HSC	HSL-3	HST3	HST2	HSA
								
Anchor size		M10-M20	M8-M20	M6-M12	M8-M24	M8-M24	M8-M16	M6-M20
Base material	Cracked concrete	■	■	■	■	■	■	
	Non-cracked	■	■	■	■	■	■	■
	Lightweight concrete							
	Aerated concrete							
	Solid brick masonry							
	Hollow brick							
	Drywall							
Redundant fastening								
Approvals	European Technical approval (ETA)	■	■	■	■	■	■	■
	ETA seismic C1	■	■		■	■		
	ETA seismic C2	■			■	■		
	Fatigue approval*	■			■			
	Shock approval*	■		■	■	■		
	Fire tested	■	■	■	■	■	■	■
Specification	Steel, galvanized	■	■	■	■	■	■	■
	Steel, hot dip galvanized	■	■					■
	Stainless steel A2							■
	Stainless steel A4	■		■	■	■	■	■
	HCR steel							
	External thread	■	■	■	■	■	■	■
	Internal thread			■				
Setting	Pre-setting	■	■	■	■	■	■	■
	Through-fastening	■			■	■	■	■
Profis		■	■	■	■	■	■	■

*Local approvals

Expansion anchors		Screw anchors					Flush anchors		
HSV	HSB	HUS3	HUS3 REDUNDANT	HUS-HR HUS-CR	HUS-V	HUS 6 HUS-S 6	HKD	HKD REDUNDANT	HKV
M8-M16	M8-M16	6-14	6	6-14	8-10	6	M6-M20	M6-M16	M6-M16
		■	■		■	■		■	
■	■	■	■	■	■	■	■	■	■
		■	■	■		■			
		■	■	■		■			
						■			
			■			■		■	
	■	■	■	■			■	■	
		■		■					
		■							
		■	■	■		■		■	
■	■	■	■	■	■	■	■	■	■
		■							
			■	■			■	■	
	■	■	■			■			
■		■	■				■	■	■
■	■						■	■	■
	■	■	■	■	■	■			
		■		■			■		

Mechanical anchor selector

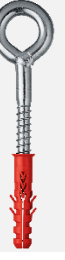



Anchor type		Plastic anchors							
		HRD	HRV	HPS-1	HUD-1	HUD-L	HLD	HMF	GD14+GRS
									
Anchor size (drill bit diameter)		M8-M10	M10	M4-M8	M5-M14	M6-M10	M10	M5-M14	M14
Base material	Cracked concrete	■							
	Non-cracked	■	■	■	■	■	■		■
	Lightweight concrete	■	◻	◻	■	■			
	Aerated concrete	■	◻	■	■	■		■	
	Solid brick masonry	■	■	■	■	■	■	■	■
	Hollow brick	■	◻	■	■	■	■	■	
	Drywall				■	■	◻	■	
Redundant fastening									
Approvals	European Technical approval (ETA)	◻							
	ETA seismic C1								
	ETA seismic C2								
	Fatigue approval*								
	Shock approval*								
	Fire tested	■							
Specification	Steel, galvanized	■	■	■				■	
	Steel, hot dip galvanized	■	■						
	Stainless steel A2	■		■					
	Stainless steel A4								
	HCR steel								
	External thread								
	Internal thread								
Setting	Pre-setting				■	■	■		
	Through-fastening	■	■	■	■	■		■	
Profis									

■ May be suitable for specific applications
 ◻ ETA approval only for redundant fastening applications
 *Local approvals

Light duty metal anchors

DBZ	HK	HLC	HT	HLV	HAM	HPD	HKH	HCA	HHD-S	HSP/HFP	HTB
M6	M8-M30	M5-M16	M8-M10	M5-M12	M6-M12	M6-M10	M6-M10	M16	M4-M8	M4,5	M5-M6
■											
■	■	■	■	■	■			■			
			■								
			■			■	■				
		■	■		■						■
			■								■
									■	■	■
■											
□	□										
■	■	■	■			■	■				
■	■	■	■	■	■	■	■	■	■	■	
	■					■	■				
	■										
	■	■		■		■	■				
	■				■				■		
	■	■		■	■	■	■		■	■	■
■		■	■	■			■				

Mechanical anchor selector

Anchor type		Insulation anchors				
		HIF	HTH	HTR-P(M)	HTS-P(M)	IDP
						
Anchor size		8	8	8	8	8
Base material	Cracked concrete			■		
	Non-cracked	■	■	■	■	■
	Lightweight concrete		■	■	■	
	Aerated concrete	■	■	■	■	
	Solid brick masonry	■	■	■	■	■
	Hollow brick	■	■	■	■	■
	Drywall					
Approvals	European Technical approval (ETA)		■	■	■	
	ETA seismic C1					
	ETA seismic C2					
	Fatigue approval*					
	Shock approval*					
	Fire tested					
Specification	Steel, galvanized		■			
	Steel, hot dip galvanized					
	Stainless steel A2					
	Stainless steel A4					
	HCR steel					
	External thread					
	Internal thread					
Setting	Pre-setting					
	Through-fastening	■	■	■	■	■
Profis						



Resistance under fire exposure

Testing conditions

Tested in cracked concrete and exposed to flames from one side without insulating or protective measures.

In case of fire attack from more than one side, the minimum edge distance shall be ≥ 300 mm.

In case of wet concrete $h_{ef}+30$ mm

ISO Curve

The ISO curve (ISO 834), also called the standard fire temperature curve, is the thermal stress generally applied in component analyses/tests in the building industry.



ZTV-ING Curve





The ZTV-ING curve applies to road tunnels in Germany regardless of their design and the type of traffic.

Testing institutions

MFPA Leipzig Warrington MPA Braunschweig iBMB Braunschweig DIBt















Chemical Anchors







Anchor	Size	h_{ef} [mm]	Characteristic tensions resistance $N_{Rk,s,fi}$ [kN]				Authority / No.
			R30	R60	R90	R120	
Anchors below tested in accordance to ISO 834 fire curve							
HIT-RE 500 V3 + HIT-V-5.8, HIT-V-8.8 	Cracked Concrete						Original Test Report: MFPA_GS-3.2/15-361-4 Data valid for steel failure
	M8	80*	0,79	0,62	0,00	0,00	
	M10	90*	1,43	1,13	0,32	0,00	
	M12	95*	2,33	1,77	0,40	0,00	
	M16	110*	4,35	3,31	1,23	0,00	
	M20	130*	6,75	5,25	3,29	1,28	
	M24	155*	9,75	7,58	5,40	3,96	
	M27	175*	12,8	9,90	7,05	5,63	
M30	195*	15,5	12,0	8,63	6,90		
HIT-RE 500 V3 + HIT-V-R 	Cracked Concrete						
	M8	80*	2,37	1,16	0,35	0,00	
	M10	90*	4,50	2,00	0,85	0,11	
	M12	95*	5,43	2,63	1,14	0,23	
	M16	110*	11,6	4,88	2,63	1,13	
	M20	130*	20,9	8,85	5,61	3,36	
	M24	155*	30,0	14,8	9,45	5,48	
	M27	175*	39,1	25,7	12,3	7,13	
M30	195*	47,8	31,4	15,0	8,70		





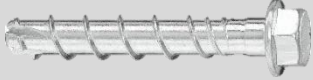

Anchor	Size	h _{ef} [mm]	Characteristic tensions resistance N _{Rk,s,fi} [kN]				Authority / No.
			R30	R60	R90	R120	
Anchors below tested in accordance to ISO 834 fire curve							
HIT-HY 200-A + HIT-V 5.8 	Cracked Concrete						Original Test Report: IBMB 3501/676/12 *For different embedment depths h _{ef} please see the full report Data valid for <u>steel</u> failure
	M8	80*	1,20	0,45	0,24	0,17	
	M10	90*	2,00	0,75	0,40	0,28	
	M12	95*	3,00	0,96	0,50	0,36	
	M16	110*	6,18	1,76	0,92	0,63	
	M20	130*	9,70	3,50	1,80	1,18	
	M24	155*	14,0	8,00	4,00	2,53	
	M27	175*	18,3	12,5	6,20	3,90	
	M30	195*	22,3	17,9	10,7	6,60	
HIT-HY 200-A + HIT-V 8.8 HIT-Z 	Cracked Concrete						
	M8	80*	1,64	0,45	0,24	0,17	
	M10	90*	2,75	0,75	0,40	0,28	
	M12	95*	3,40	0,96	0,50	0,36	
	M16	110*	6,20	1,76	0,92	0,63	
	M20	130*	12,6	3,51	1,79	1,18	
	M24	155*	23,6	8,00	4,00	2,53	
	M27	175*	30,9	16,67	8,30	5,19	
	M30	195*	37,6	21,7	10,7	6,60	
HIT-HY 200-A + HIT-V-R, HIT-Z-R 	Cracked Concrete						
	M8	80*	1,64	0,45	0,24	0,17	
	M10	90*	2,75	0,75	0,40	0,28	
	M12	95*	3,43	0,96	0,50	0,36	
	M16	110*	6,18	1,76	0,92	0,63	
	M20	130*	12,6	3,50	1,80	1,18	
	M24	155*	29,7	8,00	4,00	2,53	
	M27	175*	30,9	16,7	8,30	5,20	
	M30	195*	71,9	21,7	10,7	6,60	
HVU2 + HAS 5.8 	Cracked concrete						Original Test Report: 16056MR15542 TU Kaiserslautern *For different threaded rods please see the full report Data valid for <u>steel</u> failure
	M8	80	0,00	0,00	0,00	0,00	
	M10	90	2,90	1,75	0,73	0,35	
	M12	110	4,22	3,20	1,87	0,99	
	M16	125	7,85	5,55	2,98	1,66	
	M20	170	12,2	9,30	6,37	4,40	
	M24	210	17,6	13,4	9,18	6,35	
	M27	240	22,9	17,4	11,9	8,26	
	M30	270	28,0	21,3	14,6	10,1	

Anchor	Size	h _{ef} [mm]	Characteristic tensions resistance N _{Rk,s,fi} [kN]				Authority / No.
			R30	R60	R90	R120	
Anchors below tested in accordance to ISO 834 fire curve							
HVU2 + HAS-R 	Cracked Concrete						Original Test Report: 16056MR15542 TU Kaiserslautern *For different threaded rods please see the full report Data valid for steel failure
	M8	80	0,00	0,00	0,00	0,00	
	M10	90	4,98	1,75	0,73	0,35	
	M12	110	8,97	3,66	1,87	0,99	
	M16	125	12,8	5,55	2,98	1,66	
	M20	170	28,0	16,2	10,1	6,89	
	M24	210	40,4	28,3	16,3	10,2	
	M27	240	52,5	36,8	21,1	13,3	
M30	270	64,2	45,0	25,8	16,3		
Anchors below tested in accordance to ZTV-ING fire curve							
HIT-HY 200-A + HCR steel 	Cracked Concrete						Original Test Report: GS 3.2/15-364-2 Please notice that the data is not for any failure modes.
	M8	≥ 80			0,40		
	M10	≥ 90			0,70		
	M12	≥ 110			1,25		
	M16	≥ 125			3,50		
M20	≥ 170			4,00			
HVU2 + HAS-E-HCR 	Cracked Concrete						Original Test Report: GU-21804 Please notice that the data is not for any failure modes.
	M8	80			1,10		
	M10	90			1,50		
	M12	110			2,75		
	M16	125			4,00		
	M20	170			6,50		
M24	210			8,50			

Mechanical Anchors

Anchor	Size	h _{ef} [mm]	Characteristic tensions resistance N _{Rk,s,fi} [kN]				Authority / No.	
			R30	R60	R90	R120		
Anchors below tested in accordance to ISO 834 fire curve								
HDA 	Cracked Concrete						Original Test Report: IBMB Braunschweig UB 3039/8151 Warringtonfire WF Report no 364181 Data valid for <u>steel</u> failure.	
	M10	-	4,50	2,20	1,30	1,00		
	M12	-	10,0	3,50	1,80	1,20		
	M16	-	15,0	7,00	4,00	3,00		
M20	-	25,0	9,00	7,00	5,00			
HDA-F 	Cracked Concrete							
	M10	-	4,50	2,20	1,30	1,00		
	M12	-	10,0	3,50	1,80	1,20		
HDA-R 	Cracked Concrete							
	M10	-	20,0	9,00	4,00	2,00		
	M12	-	30,0	12,0	5,00	3,00		
HDA-R 	M16	-	50,0	15,0	7,50	6,00		
	HMU-PF 	Cracked Concrete						Original Test Report: ETA-14/0069 Data valid for <u>steel</u> failure.
		M12	80	1,70	1,30	1,10	0,80	
M16		100	3,10	2,40	2,00	1,60		
HMU-PF 	M16	125	3,10	2,40	2,00	1,60		
	HSC-A 	Cracked Concrete						Original Test Report: IBMB Braunschweig UB 3177/1722-1 Warringtonfire WF Report no 364181
		M8	-	-	-	1,50	-	
M10		-	-	-	1,50	-		
M12	-	-	3,50	2,00	-			
HSC-AR 	Cracked Concrete							
	M8	-	-	-	1,50	-		
	M10	-	-	-	1,50	-		
HSC-AR 	M12	-	-	-	3,50	3,00		
	HSC-I 	Cracked Concrete						
		M8	-	-	-	1,50	-	
M10		-	-	-	2,50	-		
HSC-I 	M12	-	-	-	2,00	-		
	HSC-IR 	Cracked Concrete						
		M8	-	-	-	1,50	-	
M10		-	-	-	2,50	-		
HSC-IR 	M12	-	-	-	3,50	3,00		
	HST-HCR 	Cracked Concrete						Original Test Report: ETA-98/001 Warringtonfire WF Report no 364181
		M8	-	1,30	2,30	2,70	1,0	
M10		-	2,30	2,30	2,30	1,8		
M12		-	3,00	3,00	3,00	2,4		
HST-HCR 	M16	-	6,30	6,30	6,30	5,00		

Anchor	Size	h _{ef} [mm]	Characteristic tensions resistance N _{Rk,s,fi} [kN]				Authority / No.	
			R30	R60	R90	R120		
HST3 	Cracked Concrete						Original Test Report: ETA-98/001 Warringtonfire WF Report no 364181	
	M8	47	0,90	0,80	0,70	0,60		
	M10	40	1,50	1,20	0,90	0,80		
	M10	60	2,40	1,80	1,20	0,90		
	M12	50	2,30	1,70	1,10	0,80		
	M12	70	5,00	3,70	2,10	1,30		
	M16	65	4,40	3,20	2,10	1,50		
	M16	85	7,10	6,80	3,90	2,40		
	M20	101	9,10	9,10	6,00	3,80		
	M24	125	12,6	12,6	8,70	5,40		
HST3-R 	Cracked Concrete							
	M8	47	1,90	1,90	1,90	1,50		
	M10	40	2,30	2,30	2,30	1,80		
	M10	60	3,00	3,00	3,00	2,40		
	M12	50	3,20	3,20	3,20	2,50		
	M12	70	5,00	5,00	5,00	4,00		
	M16	65	4,70	4,70	4,70	3,80		
	M16	85	7,10	7,10	7,10	5,60		
	M20	101	9,10	9,10	9,10	7,30		
	M24	125	12,6	12,6	12,6	10,1		
HUS3-H 	Cracked Concrete							
	M6	55	1,50	1,20	0,80	0,70		
	M8	50	1,50	1,50	1,50	1,2		
	M8	60	2,30	2,30	1,60	1,20		
	HUS3-HF 	M8	70	3,00	2,80	1,90		1,50
		M10	55	2,00	2,00	2,00		1,60
	M10	75	4,00	4,00	3,20	2,50		
	M10	85	4,90	4,70	3,20	2,50		
	M14	65	3,10	3,10	3,10	2,50		
	M14	85	4,80	4,80	4,80	3,80		
M14	115	7,80	7,80	5,50	4,30			
HUS3-C 	Cracked Concrete							
	M6	55	1,50	1,20	0,80	0,70		
	M8	50	0,50	0,40	0,30	0,20		
HUS3-A 	Cracked Concrete							
	M10	55	1,20	1,00	0,80	0,60		
HUS3-I 	Cracked Concrete							
	M6	55	1,50	1,20	0,80	0,70		

Anchor	Size	h _{ef} [mm]	Characteristic tensions resistance N _{Rk,s,fi} [kN]				Authority / No.
			R30	R60	R90	R120	
HUS3-I-Flex	Cracked Concrete						Original Test Report: ETA-13/1038 Data valid for steel failure.
	M6	55	1,60	1,20	0,80	0,70	
HUS3-P	M6	55	1,60	1,20	0,80	0,70	
HUS3-PS	M6	55	1,60	1,20	0,80	0,70	
HUS3-PL	M6	55	1,60	1,20	0,80	0,70	
HUS HR 	Cracked Concrete						Original Test Report: ETA-08/0307 Data valid for steel failure.
	M6	55	1,30	1,30	1,30	1,00	
	M8	60	1,50	1,50	1,50	1,20	
	M8	80	3,00	3,00	3,00	1,70	
	M10	70	2,30	2,30	2,30	1,80	
	M10	90	4,00	4,00	4,00	2,40	
	M14	70	3,00	3,00	3,00	2,40	
	M14	110	6,30	6,30	6,30	5,00	
HUS-CR 	M6	55	0,20	0,20	0,20	0,10	
	M8	60	0,80	0,60	0,50	0,40	
	M8	80	0,80	0,60	0,50	0,40	
	M10	70	1,40	1,10	0,90	0,80	
	M10	90	1,40	1,10	0,90	0,80	
HKD_redundant 	Cracked Concrete						Original Test Report: ETA-06/0047 Warringtonfire WF Report no 364181
	M6	25	0,50	0,40	0,30	0,20	
	M8	25	0,60	0,60	0,60	0,50	
	M8	30	0,90	0,90	0,90	0,70	
HKV 	M8	40	1,30	1,30	1,30	0,7	
	M10	25	0,60	0,60	0,60	0,5	
	M10	30	0,90	0,90	0,90	0,7	
	M10	40	1,80	1,80	1,80	1,50	
Anchors below tested in accordance to ZTV-ING fire curve							
HST3-R 	Cracked Concrete						Original Test Report: GS 3.2/14-319-3 Please notice that the data is not for any failure modes.
	M8	≥ 47			0,60		
	M10	≥ 40			1,05		
	M12	≥ 50			1,75		
	M16	≥ 65			3,60		
	M20	≥ 117			4,50		
HST-HCR 	Cracked Concrete						Original Test Report: GS 2101/679/16 Please notice that the data is not for any failure modes.
	M8	-			≥ 1,00		
	M10	-			≥ 1,50		
	M12	-			≥ 2,00		
	M16	-			≥ 4,00		

Selection of corrosion protection for anchors



	Anchors	HSA HUS3 HST3 HIT-V	HUS3-HF	HSA-F HIT-V-F	HSA-R2	HUS3-HR HSA-R HST3-R HIT-V-R HIT-Z-R	HST3-HCR
	Coating/Material	Electro galvanize	Duplex coated carbon steel	HDG/sherardized 45-50 µm	A2 AISI 304	A4 AISI 316	HCR, e.g. 1.4529
Environmental Conditions	Fastened part						
Dry indoor	Steel (zinc-coated, painted), aluminum, stainless steel	■	■	■	■	■	■
Indoor with temporary condensation	Steel (zinc-coated, painted), aluminium	-	■	■	■	■	■
	Stainless steel	-	-	-	-	-	-
Outdoor with low pollution	Steel (zinc-coated, painted), aluminium	-	□ *	□ *	■ *	■	■
	Stainless steel	-	-	-	-	-	-
Outdoor with moderate concentration of pollutants	Steel (zinc-coated, painted), aluminium	-	□ *	□ *	■ *	■	■
	Stainless steel	-	-	-	-	-	-
Coastal areas	Steel (zinc-coated, painted), aluminum, stainless steel	-	-	-	-	■	■
Outdoor, areas with heavy industrial pollution	Steel (zinc-coated, painted), aluminum, stainless steel	-	-	-	-	■	■
Close proximity to roads treated with de-icing salts	Steel (zinc-coated, painted), aluminum, stainless steel	-	-	-	-	■	■
Special applications	-	Consult experts					■





- = expected lifetime of anchors made from this material is typically satisfactory in the specified environment based on the typically expected lifetime of a building. The assumed service life in ETA approvals for powder-actuated and screw fasteners is 25 years, and for concrete anchors it is 50 years.
- = a decrease in the expected lifetime of non-stainless fasteners in these atmospheres must be taken into account (≤ 25 years). Higher expected lifetime needs a specific assessment.
- = fasteners made from this material are not suitable in the specified environment. Exceptions need a specific assessment.



* From a technical point of view, HDG/duplex coatings and A2/304 material are suitable for outdoor environments with certain lifetime and application restrictions. This is based on longterm experience with these materials as reflected e.g. in the corrosion rates for Zn given in the ISO 9224:2012 (corrosivity categories, C-classes), the selection table for stainless steel grades given in the national technical approval issued by the DIBt Z.30.3-6 (April 2009) or the ICC-ES evaluation reports for our KB-TZ anchors for North America (e.g. ESR-1917, May 2013). The use of those materials in outdoor environments however is currently not covered by the European Technical Approval (ETA) of anchors, where it is stated that anchors made of galvanized carbon steel or stainless steel grade A2 may only be used in structures subject to dry indoor conditions, based on an assumed working life of the anchor of 50 years.

Environment categories

Applications can be classified into various environmental categories, by taking the following factors into account:

Indoor applications	
	Dry indoor environments (Heated or air-conditioning areas) without condensation, e.g. office buildings, schools.
	Indoor environments with temporary condensation (Unheated areas without pollutant) e.g. storage sheds

Outdoor applications	
	Outdoor, rural or urban environment with low population Large distance (> 10 km) from the sea
	Outdoor, rural or urban environment with moderate concentration of pollutants and/or salt from sea water Distance from the sea 1-10 km
	Coastal areas Distance from sea <1 km
	Outdoor areas with heavy industrial pollution Close to plants < 1 km (e.g. petrochemical, coal industry)
	Close proximity to roadways threatened with de-icing salts Distance to roadways < 10 m

Outdoor applications	
 	Special applications Areas with special corrosive conditions, e.g. road tunnels with de-icing salt, indoor swimming pools, special applications in the chemical industry (exceptions possible).

Important notes

The ultimate decision on the required corrosion protection must be made by the customer. Hilti accepts no responsibility regarding the suitability of a product for a specific application, even if informed of the application conditions.

The tables are based on an average service life for typical applications.

For metallic coatings, e.g. zinc layer systems, the end of lifetime is the point at which red rust is visible over a large fraction of the product and widespread structural deterioration can occur – the initial onset of rust may occur sooner.

National or international codes, standards or regulations, customer and/or industry specific guidelines must be independently considered and evaluated.

These guidelines apply to atmospheric corrosion only. Special types of corrosion, such as crevice corrosion or hydrogen assisted cracking must be independently evaluated.

The tables published in this brochure describe only a general guideline for commonly accepted applications in typical atmospheric environments.

Suitability for a specific application can be significantly affected by localised conditions, including but not limited to:

Elevated temperatures and humidity; High levels of airborne pollutants; Direct contact with corrosive products, such as found in some types of chemically-treated wood, waste water, concrete additives, cleaning agents, etc. ;Direct contact to soil, stagnant water; Electrical current; Contact with dissimilar metals; Confined areas, e.g. crevices; Physical damage or wear; Extreme corrosion due to combined effects of different influencing factors; Enrichment of pollutants on the product

HIT-RE 500 V3 injection mortar

Anchor design (ETAG 001) / Rods&Sleeves / Concrete

Injection mortar system



Foil pack: HIT-RE 500 V3
(available in 330, 500 and 1400 ml cartridges)



Anchor rod:
HIT-V
HIT-V-F
HIT-V-R
HIT-V-HCR
AM 8.8 (HDG)
(M8-M39)



Internally threaded sleeve:
HIS-N,
HIS-RN
(M8-M20)

Benefits

- **SafeSet** technology: Simplified method of borehole preparation using either Hilti hollow drill bit for hammer drilling or Roughening tool for diamond cored applications
- Suitable for cracked/non-cracked concrete C 20/25 to C 50/60
- High loading capacity
- Suitable for dry and water saturated concrete
- Hilti Technical Data for under water application
- High corrosion resistance
- Long working time at elevated temperatures
- Cures down to -5°C
- Odourless epoxy

Base material



Concrete (non-cracked)



Concrete (cracked)

Installation conditions

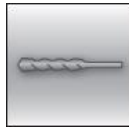

Hammer drilled holes



Diamond drilled holes

SAFE-SET

Hilti **SafeSet** technology

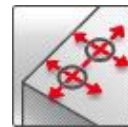

Small edge distance and spacing

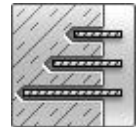

Variable embedment depth

Load conditions

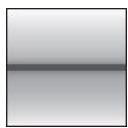

Static/
quasi-static



Seismic,
ETA-C1, C2



Fire
resistance

Other information



European
Technical
Assessment



CE conformity



PROFIS
design
Software

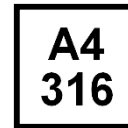

Corrosion
resistance



High
corrosion
resistance ^{a)}

a) Applications only with HIT-V anchor rods

Approvals / certificates

Description	Authority / Laboratory	No. / date of issue
European Technical Assessment ^{a)}	CSTB	ETA-16/0143 / 2017-07-12
Shockproof fastenings in civil defence installations	Federal Office for Civil Protection, Bern	BZS D 16-601/ 2016-08-31
Fire test report ^{b)}	MFPA Leipzig	GS 3.2/15-361-4 / 2016-08-04

a) All data given in this section according to ETA-16/0143, issue 2017-07-12.

b) Fire test report only available for HIT-V rods.

Static and quasi-static resistance (for a single anchor)

All data in this section applies to:

- Correct setting (See setting instruction)
- No edge distance and spacing influence
- Steel failure
- HIT-V anchor rod with strength class 5.8 and 8.8, AM anchor rod with strength class 8.8, HIS-N internally threaded insert with screw 8.8
- Base material thickness, as specified in the table
- One typical embedment depth as specified in the table
- Concrete C 20/25, $f_{ck,cube} = 25 \text{ N/mm}^2$
- Temperature range I
(min. base material temperature -40°C , max. long/short term base material temperature: $+24^\circ\text{C}/40^\circ\text{C}$)

Embedment depth ^{a)} and base material thickness

Anchor size	ETA-16/0143, issue 2017-07-12								Hilti technical data		
	M8	M10	M12	M16	M20	M24	M27	M30	M33	M36	M39
HIT-V											
Eff. anchorage depth [mm]	80	90	110	125	170	210	240	270	300	330	360
Base material thickness [mm]	110	120	140	161	214	266	300	340	374	410	444
HIS-N											
Eff. anchorage depth [mm]	90	110	125	170	205	-	-	-	-	-	-
Base material thickness [mm]	120	150	170	230	270	-	-	-	-	-	-

a) The allowed range of embedment depth is shown in the setting

For hammer drilled holes, hollow drill bit¹⁾ and diamond cored with roughening tool²⁾:

Characteristic resistance

Anchor size	ETA-16/0143, issue 2017-07-12								Hilti technical data			
	M8	M10	M12	M16	M20	M24	M27	M30	M33	M36	M39	
Non-cracked concrete												
Tension N_{Rk} [kN]	HIT-V 5.8	18,0	29,0	42,0	70,6	111,	153,	187,	224,	262,4	302,7	344,9
	HIT-V 8.8, AM	29,0	43,1	58,3	70,6	111,	153,	187,	224,	262,4	302,7	344,9
	HIT-V-R	26,0	41,0	58,3	70,6	111,	153,	187,	224,	262,4	302,7	344,9
	HIT-V-HCR	29,0	43,1	58,3	70,6	111,	153,	187,	224,	262,4	302,7	334,9
	HIS-N 8.8	25,0	46,0	67,0	111,	116,	-	-	-	-	-	-
Shear V_{Rk} [kN]	HIT-V 5.8	9,0	15,0	21,0	39,0	61,0	88,0	115,	140,	174,0	204,0	244,0
	HIT-V 8.8, AM	15,0	23,0	34,0	63,0	98,0	141,	184,	224,	278,0	327,0	390,0
	HIT-V-R	13,0	20,0	30,0	55,0	86,0	124,	115,	140,	174,0	204,0	244,0
	HIT-V-HCR	15,0	23,0	34,0	63,0	98,0	124,	161,	196,	174,0	204,0	244,0
	HIS-N 8.8	13,0	23,0	34,0	63,0	58,0	-	-	-	-	-	-
Cracked concrete												
Tension N_{Rk} [kN]	HIT-V 5.8	13,1	21,2	33,2	50,3	79,8	109,	133,	159,	-	-	-
	HIT-V 8.8, AM	13,1	21,2	33,2	50,3	79,8	109,	133,	159,	-	-	-
	HIT-V-R	13,1	21,2	33,2	50,3	79,8	109,	133,	159,	-	-	-
	HIT-V-HCR	13,1	21,2	33,2	50,3	79,8	109,	113,	159,	-	-	-
	HIS-N 8.8	25,0	41,5	50,3	79,8	105,	-	-	-	-	-	-
Shear V_{Rk} [kN]	HIT-V 5.8	9,0	15,0	21,0	39,0	61,0	88,0	115,	140,	-	-	-
	HIT-V 8.8, AM	15,0	23,0	34,0	63,0	98,0	141,	184,	224,	-	-	-
	HIT-V-R	13,0	20,0	30,0	55,0	86,0	124,	115,	140,	-	-	-
	HIT-V-HCR	15,0	23,0	34,0	63,0	98,0	124,	161,	196,	-	-	-
	HIS-N 8.8	13,0	23,0	34,0	63,0	58,0	-	-	-	-	-	-

1) Hilti hollow drill bit available for element size M12-M30.

2) Roughening tools are available for element size M16-M30.

Design resistance

Anchor size		ETA-16/0143, issue 2017-07-12								Hilti technical data		
		M8	M10	M12	M16	M20	M24	M27	M30	M33	M36	M39
Non-cracked concrete												
Tension N_{Rd}	HIT-V 5.8	12,0	19,3	28,0	47,1	74,6	102,	125,	149,	145,8	168,2	191,6
	HIT-V 8.8, AM 8.8	19,3	28,7	38,8	47,1	74,6	102,	125,	149,	145,8	168,2	191,6
	HIT-V-R [kN]	13,9	21,9	31,6	47,1	74,6	102,	80,4	98,3	121,3	143,0	170,6
	HIT-V-HCR	19,3	28,7	38,8	47,1	74,6	102,	125,	149,	144,6	168,2	191,6
	HIS-N 8.8	16,7	30,7	44,7	74,6	77,3	-	-	-	-	-	-
Shear V_{Rd}	HIT-V 5.8	7,2	12,0	16,8	31,2	48,8	70,4	92,0	112,	139,2	163,2	195,2
	HIT-V 8.8, AM 8.8	12,0	18,4	27,2	50,4	78,4	112,	147,	179,	222,4	261,6	312,0
	HIT-V-R [kN]	8,3	12,8	19,2	35,3	55,4	79,5	48,3	58,8	73,1	85,7	102,5
	HIT-V-HCR	12,0	18,4	27,2	50,4	78,4	70,9	92,0	112,	87,0	102,0	122,0
	HIS-N 8.8	10,4	18,4	27,2	50,4	46,4	-	-	-	-	-	-
Cracked concrete												
Tension N_{Rd}	HIT-V 5.8	8,7	14,1	22,1	33,5	53,2	73,0	89,2	106,	-	-	-
	HIT-V 8.8, AM 8.8	8,7	14,1	22,1	33,5	53,2	73,0	89,2	106,	-	-	-
	HIT-V-R [kN]	8,7	14,1	22,1	35,5	53,2	73,0	80,4	98,3	-	-	-
	HIT-V-HCR	8,7	14,1	22,1	33,5	53,2	73,0	89,2	106,	-	-	-
	HIS-N 8.8	16,7	27,7	33,5	53,2	70,4	-	-	-	-	-	-
Shear V_{Rd}	HIT-V 5.8	7,2	12,0	16,8	31,2	48,8	70,4	92,0	112,	-	-	-
	HIT-V 8.8, AM 8.8	12,0	18,4	27,2	50,4	78,4	112,	147,	179,	-	-	-
	HIT-V-R [kN]	8,3	12,8	19,2	35,3	55,1	79,5	48,3	58,8	-	-	-
	HIT-V-HCR	12,0	18,4	27,2	50,4	78,4	70,9	92,0	112,	-	-	-
	HIS-N 8.8	10,4	18,4	27,2	50,4	46,4	-	-	-	-	-	-

- 1) Hilti hollow drill bit available for element size M12-M30.
 2) Roughening tools are available for element size M16-M30.

Recommended loads ^{a)}

Anchor size		ETA-16/0143, issue 2017-07-12								Hilti technical data		
		M8	M10	M12	M16	M20	M24	M27	M30	M33	M36	M39
Non-cracked concrete												
Tension N_{Rec}	HIT-V 5.8	8,6	13,8	20,0	33,6	53,3	73,2	89,4	106,7	104,1	120,1	136,9
	HIT-V-R [kN]	9,9	15,7	22,5	33,6	53,3	73,2	57,4	70,2	86,7	102,1	121,9
	HIT-V-HCR	13,8	20,5	27,7	33,6	53,3	73,2	89,4	106,7	103,3	120,1	136,9
	HIS-N 8.8	16,7	30,7	44,7	74,6	77,3	-	-	-	-	-	-
Shear V_{Rec}	HIT-V 5.8	5,1	8,6	12,0	22,3	34,9	50,3	65,7	80,0	99,4	116,6	139,4
	HIT-V-R [kN]	6,0	9,2	13,7	25,2	39,4	56,8	34,5	42,0	52,2	61,2	73,2
	HIT-V-HCR	8,6	13,1	19,4	36,0	56,0	50,6	65,7	80,0	62,1	72,9	87,1
	HIS-N 8.8	10,4	18,4	27,2	50,4	46,4	-	-	-	-	-	-
Cracked concrete												
Tension N_{Rec}	HIT-V 5.8	6,2	10,1	15,8	23,9	38,0	52,2	63,7	76,1	-	-	-
	HIT-V-R [kN]	6,2	10,1	15,8	23,9	38,0	52,2	57,4	70,2	-	-	-
	HIT-V-HCR	6,2	10,1	15,8	23,9	38,0	52,2	63,7	76,1	-	-	-
	HIS-N	16,7	27,7	33,5	53,2	70,4	-	-	-	-	-	-
Shear V_{Rec}	HIT-V 5.8	5,1	8,6	12,0	22,3	34,9	50,3	65,7	80,0	-	-	-
	HIT-V-R [kN]	6,0	9,2	13,7	25,2	39,4	56,8	34,5	42,0	-	-	-
	HIT-V-HCR	8,6	13,1	19,4	36,0	56,0	50,6	65,7	80,0	-	-	-
	HIS-N 8.8	10,4	18,4	27,2	50,4	46,4	-	-	-	-	-	-

- a) With overall partial safety factor for action $\gamma=1,4$. The partial safety factors for action depend on the type of loading and shall be taken from national regulations.

For diamond drilling ^{a)}:

Characteristic resistance

Anchor size		M8	M10	M12	M16	M20	M24	M27	M30
Non-cracked concrete									
Tension N_{Rk}	HIT-V 5.8 [kN]	18,0	29,0	42,0	70,6	111,9	153,7	187,8	224,0
	HIT-V 8.8, AM 8.8	24,1	33,9	49,8	70,6	111,9	153,7	187,8	224,0
Shear V_{Rk}	HIT-V 5.8 [kN]	9,0	15,0	21,0	39,0	61,0	88,0	115,0	140,0
	HIT-V 8.8, AM 8.8	15,0	23,0	34,0	63,0	98,0	141,0	184,0	224,0

a) No data for HIS-N when diamond coring without roughening tools.

Design resistance

Anchor size		M8	M10	M12	M16	M20	M24	M27	M30
Non-cracked concrete									
Tension N_{Rd}	HIT-V 5.8 [kN]	12,0	18,8	27,6	33,6	53,3	73,2	89,4	106,7
	HIT-V 8.8, AM 8.8	13,4	18,8	27,6	33,6	53,3	73,2	89,4	106,7
Shear V_{Rd}	HIT-V 5.8 [kN]	7,2	12,0	16,8	31,2	48,8	70,4	92,0	112,0
	HIT-V 8.8, AM 8.8	12,0	18,4	27,2	50,4	78,4	112,8	147,2	179,2

a) No data for HIS-N when diamond coring without roughening tools.

Recommended loads ^{b)}

Anchor size		M8	M10	M12	M16	M20	M24	M27	M30
Non-cracked concrete									
Tensile N_{Rec}	HIT-V 5.8 [kN]	8,6	13,5	19,7	24,0	38,1	52,3	63,9	76,2
Shear V_{Rec}	HIT-V 5.8 [kN]	5,1	8,6	12,0	22,3	34,9	50,3	65,7	80,0

a) No data for HIS-N when diamond coring without roughening tools.

b) With overall partial safety factor for action $\gamma=1,4$. The partial safety factors for action depend on the type of loading and shall be taken from national regulations.

Seismic resistance

All data in this section applies to:

- Correct setting (See setting instruction)
- No edge distance and spacing influence
- Steel failure
- Anchor HIT-V strength class 8.8, anchor AM 8.8
- Base material thickness, as specified in the table
- One typical embedment depth as specified in the table
- Concrete C 20/25, $f_{ck,cube} = 25 \text{ N/mm}^2$
- Temperature range I
(min. base material temperature -40°C , max. long/short term base material temperature: $+24^\circ\text{C}/40^\circ\text{C}$)
- $\alpha_{gap}=1,0$ (using Hilti seismic filling set)

Embedment depth and base material thickness for seismic C2 ^{a)} and C1

Anchor size		M8	M10	M12	M16	M20	M24	M27	M30
HIT-V									
Eff. Anchorage depth	[mm]	80	90	110	125	170	210	240	270
Base material thickness	[mm]	110	120	140	165	220	270	300	340
HIS-N									
Eff. Anchorage depth	[mm]	90	110	125	170	205	-	-	-
Base material thickness	[mm]	120	146	169	226	269	-	-	-

a) C2 seismic approval only available for HIT-V rods.

For hammer drilled holes, hollow drill bit and diamond cored with roughening tool:

Characteristic resistance in case of seismic performance category C2 using Hilti seismic filling set

Anchor size		M8	M10	M12	M16	M20	M24	M27	M30
Tensile N_{Rk}	HIT-V 8.8, AM 8.8 [kN]	-	-	-	34,6	57,7	80,8	-	-
Shear V_{Rk}	HIT-V 8.8, AM 8.8 [kN]	-	-	-	46,0	77,0	103,0	-	-
	HIT-V-F 8.8 AM-HDG 8.8 [kN]	-	-	-	30,0	46,0	66,0	-	-

Design resistance in case of seismic performance category C2 using Hilti seismic filling set

Anchor size		M8	M10	M12	M16	M20	M24	M27	M30
Tensile N_{Rd}	HIT-V 8.8, AM 8.8 [kN]	-	-	-	23,0	38,5	53,8	-	-
Shear V_{Rd}	HIT-V 8.8, AM 8.8 [kN]	-	-	-	36,8	61,6	82,4	-	-
	HIT-V-F 8.8 AM-HDG 8.8 [kN]	-	-	-	24,0	36,8	52,8	-	-

For hammer drilled holes and hammer drilled holes with Hilti hollow drill bit:

Characteristic resistance in case of seismic performance category C1

Anchor size		M8	M10	M12	M16	M20	M24	M27	M30
Tensile N_{Rk}	HIT-V 8.8, AM 8.8 [kN]	12,1	19,8	32,8	42,8	67,8	93,1	113,8	135,8
	HIS-N 8.8 [kN]	25,0	35,3	42,8	67,8	89,8	-	-	-
Shear V_{Rk}	HIT-V 8.8, AM 8.8 [kN]	15,0	23,0	34,0	63,0	98,0	141,0	184,0	224,0
	HIS-N 8.8 [kN]	9,0	16,0	24,0	44,0	41,0	-	-	-

Design resistance in case of seismic performance category C1

Anchor size		M8	M10	M12	M16	M20	M24	M27	M30
Tensile N_{Rd}	HIT-V 8.8, AM 8.8 [kN]	8,0	13,2	21,8	28,5	45,2	62,1	75,9	90,5
	HIS-N 8.8	16,7	23,5	28,5	45,2	59,9	-	-	-
Shear V_{Rd}	HIT-V 8.8, AM 8.8 [kN]	12,0	18,4	27,2	50,4	78,4	112,8	147,2	179,2
	HIS-N 8.8	7,2	12,8	19,2	35,2	32,8	-	-	-

Materials
Mechanical properties for HIT-V

Anchor size		ETA-16/0143, issue 2017-07-12								Hilti Technical data		
		M8	M10	M12	M16	M20	M24	M27	M30	M33	M36	M39
Nominal tensile strength f_{uk}	HIT-V 5.8(F)	500	500	500	500	500	500	500	500	500	500	500
	HIT-V 8.8(F)	800	800	800	800	800	800	800	800	800	800	800
	AM 8.8(HDG) [N/mm ²]	800	800	800	800	800	800	800	800	800	800	800
	HIT-V-R	700	700	700	700	700	700	500	500	500	500	500
	HIT-V-HCR	800	800	800	800	800	700	700	700	500	500	500
Yield strength f_{yk}	HIT-V 5.8(F)	400	400	400	400	400	400	400	400	400	400	400
	HIT-V 8.8(F)	640	640	640	640	640	640	640	640	640	640	640
	AM 8.8(HDG) [N/mm ²]	640	640	640	640	640	640	640	640	640	640	640
	HIT-V-R	450	450	450	450	450	450	210	210	210	210	210
	HIT-V-HCR	640	640	640	640	640	400	400	400	250	250	250
Stressed cross-section A_s	HIT-V AM 8.8 [mm ²]	36,6	58,0	84,3	157	245	353	459	561	694	817	976
Moment of resistance W	HIT-V AM 8.8 [mm ³]	31,2	62,3	109	277	541	935	1387	1874	2579	3294	4301

Mechanical properties for HIS-N

Anchor size		ETA-16/0143, issue 2017-07-12				
		M8	M10	M12	M16	M20
Nominal tensile strength f_{uk}	HIS-N	490	490	460	460	460
	Screw 8.8 [N/mm ²]	800	800	800	800	800
	HIS-RN	700	700	700	700	700
	Screw A4-70	700	700	700	700	700
Yield strength f_{yk}	HIS-N	410	410	375	375	375
	Screw 8.8 [N/mm ²]	640	640	640	640	640
	HIS-RN	350	350	350	350	350
	Screw A4-70	450	450	450	450	450
Stressed cross-section A_s	HIS-(R)N [mm ²]	51,5	108,0	169,1	256,1	237,6
	Screw	36,6	58	84,3	157	245
Moment of resistance W	HIS-(R)N [mm ³]	145	430	840	1595	1543
	Screw	31,2	62,3	109	277	541

Material quality for HIT-V

Part	Material
Zinc coated steel	
Threaded rod, HIT-V 5.8 (F)	Strength class 5.8; Elongation at fracture A5 > 8% ductile Electroplated zinc coated $\geq 5\mu\text{m}$; (F) hot dip galvanized $\geq 45\mu\text{m}$
Threaded rod, HIT-V 8.8 (F)	Strength class 8.8; Elongation at fracture A5 > 12% ductile Electroplated zinc coated $\geq 5\mu\text{m}$; (F) hot dip galvanized $\geq 45\mu\text{m}$
Hilti Meter rod, AM 8.8 (HDG)	Strength class 8.8; Elongation at fracture A5 > 12% ductile Electroplated zinc coated $\geq 5\mu\text{m}$ (HDG) hot dip galvanized $\geq 45\mu\text{m}$
Washer	Electroplated zinc coated $\geq 5\mu\text{m}$, hot dip galvanized $\geq 45\mu\text{m}$
Nut	Strength class of nut adapted to strength class of threaded rod. Electroplated zinc coated $\geq 5\mu\text{m}$, hot dip galvanized $\geq 45\mu\text{m}$
Stainless Steel	
Threaded rod, HIT-V-R	Strength class 70 for $\leq M24$ and strength class 50 for $> M24$; Elongation at fracture A5 > 8% ductile Stainless steel 1.4401; 1.4404; 1.4578; 1.4571; 1.4439; 1.4362
Washer	Stainless steel 1.4401, 1.4404, 1.4578, 1.4571, 1.4439, 1.4362 EN 10088-1:2014
Nut	Stainless steel 1.4401, 1.4404, 1.4578, 1.4571, 1.4439, 1.4362 EN 10088-1:2014
High corrosion resistant steel	
Threaded rod, HIT-V-HCR	Strength class 80 for $\leq M20$ and class 70 for $> M20$, Elongation at fracture A5 > 8% ductile High corrosion resistance steel 1.4529; 1.4565;
Washer	High corrosion resistant steel 1.4529, 1.4565 EN 10088-1:2014
Nut	High corrosion resistant steel 1.4529, 1.4565 EN 10088-1:2014

Material quality for HIS-N

Part	Material	
HIS-N	Internal threaded sleeve	C-steel 1.0718; Steel galvanized $\geq 5\mu\text{m}$
	Screw 8.8	Strength class 8.8, A5 > 8 % Ductile; Steel galvanized $\geq 5\mu\text{m}$
HIS-RN	Internal threaded sleeve	Stainless steel 1.4401, 1.4571
	Screw 70	Strength class 70, A5 > 8 % Ductile Stainless steel 1.4401; 1.4404, 1.4578; 1.4571; 1.4439; 1.4362

Setting information

Installation temperature

-5°C to +40°C

Service temperature range

Hilti HIT-RE 500 V3 injection mortar may be applied in the temperature ranges given below. An elevated base material temperature may lead to a reduction of the design bond resistance.

Temperature range	Base material temperature	Max. long term base material temperature	Max. short term base material temperature
Temperature range I	-40 °C to +40 °C	+24 °C	+40 °C
Temperature range II	-40 °C to +70 °C	+43 °C	+70 °C

Max short term base material temperature

Short-term elevated base material temperatures are those that occur over brief intervals, e.g. as a result of diurnal cycling.

Max long term base material temperature

Long-term elevated base material temperatures are roughly constant over significant periods of time.

Working time and curing time

Temperature of the base material T	Working time t _{work}	Minimum curing time t _{cure} ¹⁾
-5 °C to -1 °C	2 h	168 h
0 °C to 4 °C	2 h	48 h
5 °C to 9 °C	2 h	24 h
10 °C to 14 °C	1,5 h	16 h
15 °C to 19 °C	1 h	12 h
20 °C to 24 °C	30 min	7 h
25 °C to 29 °C	20 min	6 h
30 °C to 34 °C	15 min	5 h
35 °C to 39 °C	12 min	4,5 h
40 °C	10 min	4 h

1) The curing time data are valid for dry base material only. In wet base material, the curing times must be doubled.

Setting details for HIT-V

Anchor size		ETA-16/0143, issue 2017-07-12								Hilti Technical data		
		M8	M10	M12	M16	M20	M24	M27	M30	M33	M36	M39
Nominal diameter of drill bit	d ₀ [mm]	10	12	14	18	22	28	30	35	37	40	42
Effective anchorage and drill hole depth range ^{a)}	h _{ef,min} [mm]	60	60	70	80	90	96	108	120	132	144	156
	h _{ef,max} [mm]	160	200	240	320	400	480	540	600	660	720	780
Minimum base material thickness	h _{min} [mm]	h _{ef} +30 mm ≥ 100 mm				h _{ef} + 2 d ₀						
Max. torque moment	T _{max} [mm]	10	20	40	80	150	200	270	300	330	360	390
Minimum spacing	s _{min} [mm]	40	50	60	75	90	115	120	140	165	180	195
Min. edge distance	c _{min} [mm]	40	45	45	50	55	60	75	80	165	180	195
Critical spacing for splitting failure	s _{cr,sp} [mm]	2 c _{cr,sp}										
Critical edge distance for splitting failure ^{b)}	c _{cr,sp} [mm]	1,0 · h _{ef} for h / h _{ef} ≥ 2,0										
		4,6 h _{ef} - 1,8 h for 2,0 > h / h _{ef} > 1,3										
		2,26 h _{ef} for h / h _{ef} ≤ 1,3										
Critical spacing for concrete cone failure	s _{cr,N} [mm]	2 c _{cr,N}										
Critical edge distance for concrete cone failure ^{c)}	c _{cr,N} [mm]	1,5 h _{ef}										

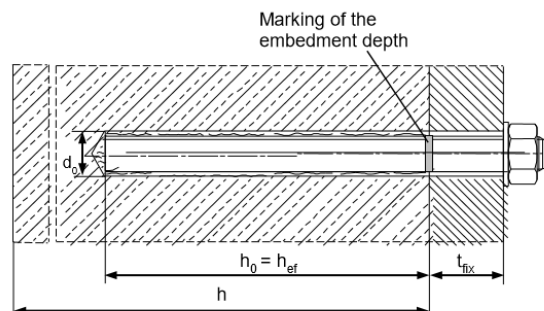
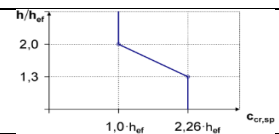

Setting details for HIS-N

Anchor size		M8	M10	M12	M16	M20
Nominal diameter of drill	d_0 [mm]	14	18	22	28	32
Diameter of element	d [mm]	12,5	16,5	20,5	25,4	27,6
Effective anchorage and drill hole depth	h_{ef} [mm]	90	110	125	170	205
Minimum base material thickness	h_{min} [mm]	120	150	170	230	270
Diameter of clearance hole in the fixture	d_f [mm]	9	12	14	18	22
Thread engagement length; min - max	h_s [mm]	8-20	10-25	12-30	16-40	20-50
Minimum spacing	s_{min} [mm]	60	70	90	115	130
Minimum edge distance	c_{min} [mm]	40	45	55	65	90
Critical spacing for splitting failure	$s_{cr,sp}$ [mm]	$2 C_{cr,sp}$				
Critical edge distance for splitting failure ^{b)}	$C_{cr,sp}$ [mm]	$1,0 \cdot h_{ef}$ for $h / h_{ef} \geq 2,0$				
		$4,6 h_{ef} - 1,8 h$ for $2,0 > h / h_{ef} > 1,3$				
		$2,26 h_{ef}$ for $h / h_{ef} \leq 1,3$				
Critical spacing for concrete cone failure	$s_{cr,N}$ [mm]	$2 C_{cr,N}$				
Critical edge distance for concrete cone failure ^{c)}	$C_{cr,N}$ [mm]	$1,5 h_{ef}$				
Max. torque moment ^{a)}	T_{max} [Nm]	10	20	40	80	150

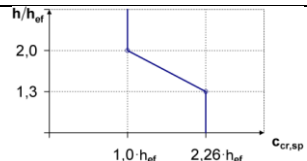

For spacing (edge distance) smaller than critical spacing (critical edge distance) the design loads have to be reduced.

a) $h_{ef,min} \leq h_{ef} \leq h_{ef,max}$ (h_{ef} : embedment depth)

b) h : base material thickness ($h \geq h_{min}$)

c) The critical edge distance for concrete cone failure depends on the embedment depth h_{ef} and the design bond resistance. The simplified formula given in this table is on the save side.

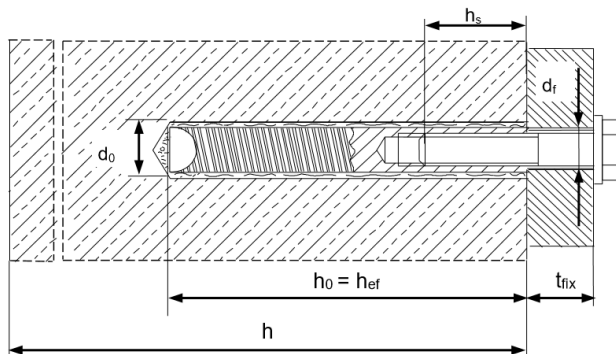
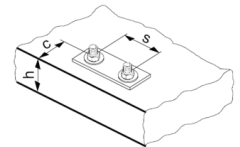

Installation equipment

Anchor size		M8	M10	M12	M16	M20	M24	M27	M30	M36	M39	
Rotary hammer	HIT-V	TE 2 – TE 16				TE 40 – TE 80				Not available from Hilti		
	HIS-N	TE 2 – TE 16		TE 40 – TE 80			-					
Other tools		compressed air gun, set of cleaning brushes, dispenser										
		roughening tools TE-YRT									-	
Additional Hilti recommended tools		DD EC-1, DD 100 ... DD 160 ^{a)}									-	

a) For anchors in diamond drilled holes load values for combined pull-out and concrete cone resistance have to be reduced

Minimum roughening time t_{roughen} ($t_{\text{roughen}} [\text{sec}] = h_{\text{ef}} [\text{mm}] / 10$)

$h_{\text{ef}} [\text{mm}]$	$t_{\text{roughen}} [\text{sec}]$
0 to 100	10
101 to 200	20
201 to 300	30
301 to 400	40
401 to 500	50
501 to 600	60

Parameters of cleaning and setting tools

HIT-V	HIS-N	Drill bit diameters d_0 [mm]				Installation	
		Hammer drill (HD)	Hollow Drill Bit (HDB)	Diamond coring		Brush HIT-RB	Piston plug HIT-SZ
				Diamond coring (DD)	With roughening tool (RT)		
M8	-	10	-	10	-	10	-
M10	-	12	-	12	-	12	12
M12	M8	14	14	14	-	14	14
M16	M10	18	18	18	18	18	18
M20	M12	22	22	22	22	22	22
M24	M16	28	28	28	28	28	28
M27	-	30	-	30	30	30	30
-	M20	32	32	32	32	32	32
M30	-	35	35	35	35	35	35
M33	-	37	-	-	-	37	37
M36	-	40	-	-	-	40	40
M39	-	42	-	-	-	42	42

Associated components for the use of Hilti Roughening tool TE-YRT

Diamond coring		Roughening tool TE-YRT	Wear gauge RTG...
d_0 [mm]		d_0 [mm]	size
Nominal	measured		
18	17,9 to 18,2	18	18
20	19,9 to 20,2	20	20
22	21,9 to 22,2	22	22
25	24,9 to 25,2	25	25
28	27,9 to 28,2	28	28
30	29,9 to 30,2	30	30
32	31,9 to 32,2	32	32
35	34,9 to 35,2	35	35

Setting instructions

*For detailed information on installation see instruction for use given with the package of the product.



Safety regulations.

Review the Material Safety Data Sheet (MSDS) before use for proper and safe handling! Wear well-fitting protective goggles and protective gloves when working with Hilti HIT-RE 500 V3.

Drilling

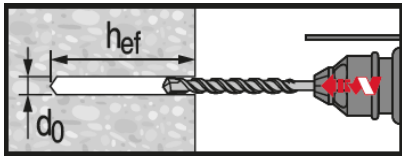

Hammer drilled hole

For dry and wet concrete and installation in flooded holes (no sea water).

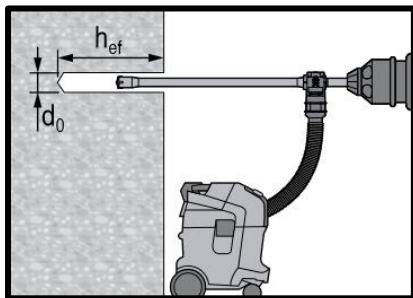

Hammer drilled hole with Hollow Drilled Bit (HDB)

No cleaning required.
For dry and wet concrete, only.

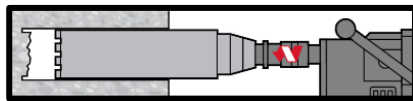

Diamond Coring

For dry and wet concrete, only.

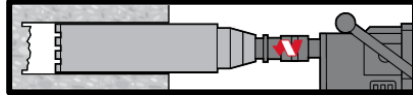

Diamond Coring + Roughening Tool

For dry and wet concrete only.
Before roughening, the borehole needs to be dry.

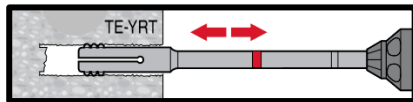

Cleaning (Inadequate hole cleaning=poor load values.)

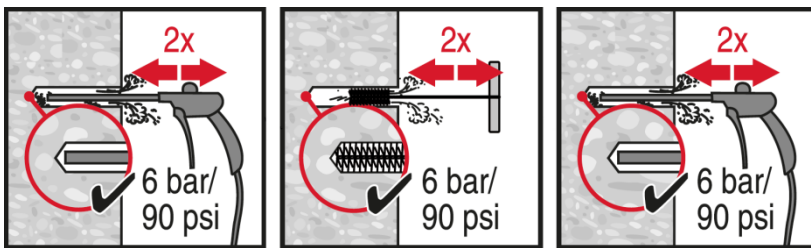

Hammer Drilling:

Compressed air cleaning (CAC)

For all drill hole diameters d_0 and all drill hole depths h_0 .

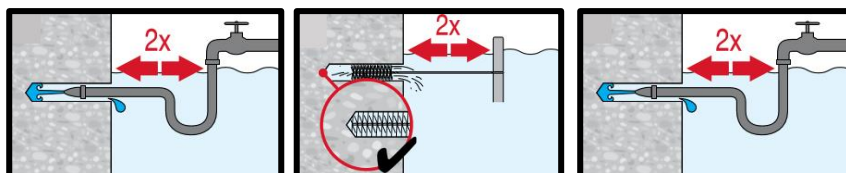

Hammer drilling:

Cleaning for under water:

For all bore hole diameters d_0 and all bore hole depth h_0 .

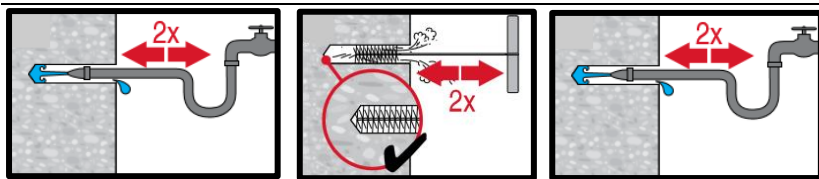

Hammer drilled flooded holes and diamond cored holes:

Compressed air cleaning (CAC)
for all drill hole diameters d_0 and drill hole depths h_0 .

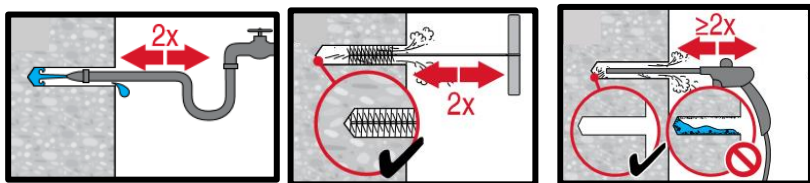
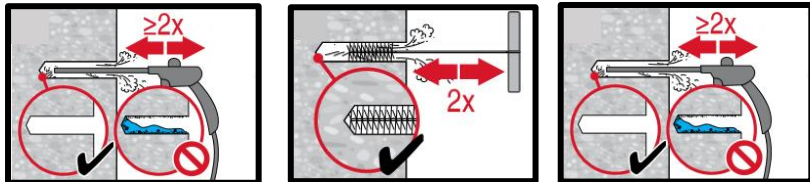

Diamond cored holes with Hilti roughening tool:

Compressed air cleaning (CAC)
for all drill hole diameters d_0 and drill hole depths h_0 .

Injection preparation

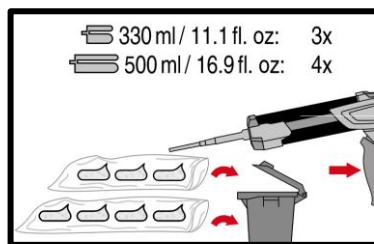
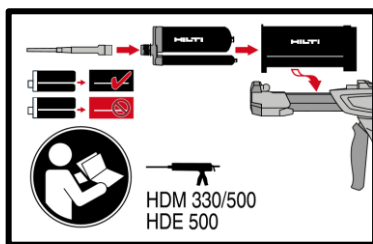

Injection system preparation.

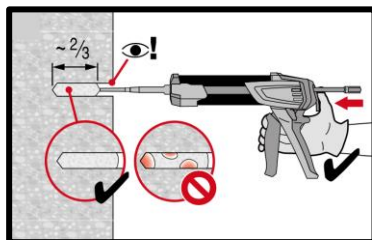
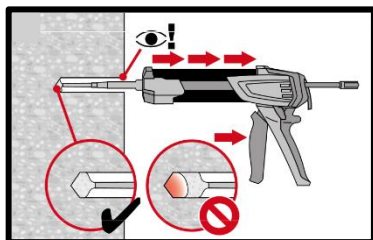

Injection method for drill hole depth
 $h_{ef} \leq 250$ mm.

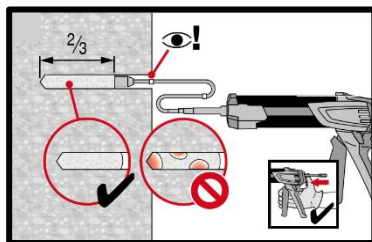
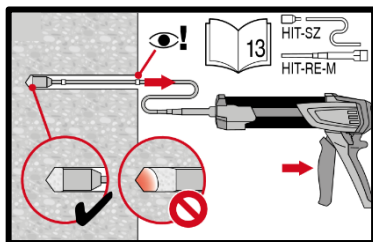

Injection method for drill hole depth
 $h_{ef} > 250$ mm.

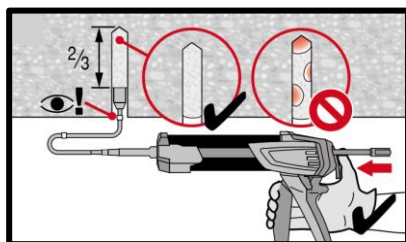
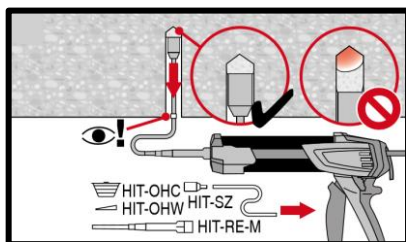

Injection method for overhead
application.

Setting the element

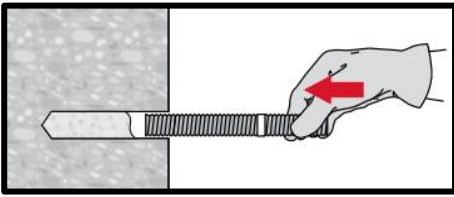

Setting element, observe working time " t_{work} ",

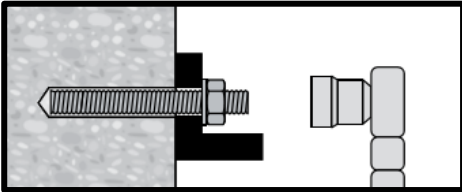

Loading the anchor after required curing time t_{cure} the anchor can be loaded. The applied installation torque shall not exceed T_{max} .

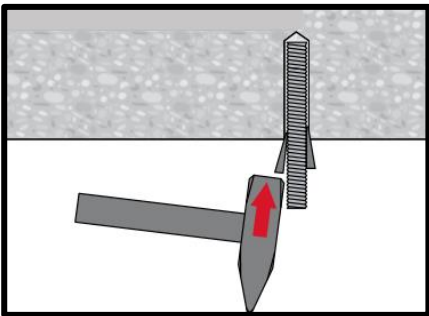

Setting element for overhead applications, observe working time " t_{work} "

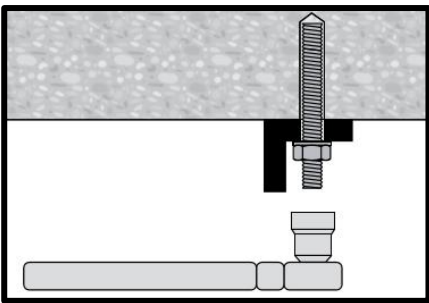

Loading the anchor after required curing time t_{cure} the anchor can be loaded. The applied installation torque shall not exceed T_{max} .



Concrete

Chemical anchors

Mechanical anchors

Plastic/Light duty metal anchors

Insulation anchors



HIT-RE 500 V3 injection mortar

Anchor design (ETAG 001) / Rebar elements / Concrete

Concrete

Chemical anchors

Mechanical anchors

Plastic/Light duty metal anchors

Insulation anchors

Injection mortar system



Hilti
HIT-RE 500 V3
500 ml foil pack

(also available as
330 ml and 1400
ml foil pack)



Rebar B500 B
($\phi 8$ - $\phi 40$)

Benefits

- **SafeSet** technology: Simplified method of borehole preparation using either Hilti hollow drill bit for hammer drilling or Roughening tool for diamond cored applications
- Suitable for non-cracked and cracked concrete C 20/25 to C 50/60
- ETA approval for seismic performance category C1
- Hilti Technical Data for seismic performance category C2
- High loading capacity
- Suitable for dry and water saturated concrete
- Hilti Technical Data for under water application
- Fastest curing epoxy mortar to speed up construction process
- Long working time to allow installation of big diameters and/or deep embedment depths even at higher temperature
- Cures down to -5°C

Base material



Concrete (non-cracked)



Concrete (cracked)



Dry concrete



Wet concrete

Load conditions



Static/
quasi-static



Seismic,
ETA-C1

Hilti Technical Data-C2

Installation conditions

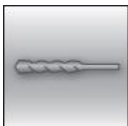

Hammer
drilling



Diamond
coring

SAFE-SET

Hilti **SafeSet**
technology

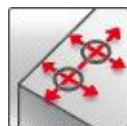

Small edge
distance and
spacing



European
Technical
Assessment



CE
conformity



PROFIS
Rebar design
Software

Approvals / certificates

Description	Authority / Laboratory	No. / date of issue
European technical assessment ^{a)}	CSTB, Marne la Vallée	ETA-16/0143 / 2017-07-12

a) All data given in this section according to ETA-16/0143 issue 2016-11-30.

Static and quasi-static loading (for a single anchor)

All data in this section applies to

- Design according to TR029
- Correct setting (See setting instruction)
- No edge distance and spacing influence
- Steel failure
- Base material thickness, as specified in the table
- One typical embedment depth, as specified in the table
- Rebar B500B
- Concrete C 20/25, $f_{ck,cube} = 25 \text{ N/mm}^2$
- Temperature range I (min. base material temp. -40°C , max. long term/short term base material temp.: $+24^\circ\text{C}/40^\circ\text{C}$)

Embedment depth and base material thickness for static and quasi-static loading data

Anchor- size	ETA-16/0143, issue 2017-07-12										Hilti technical data	
	φ8	φ10	φ12	φ14	φ16	φ20	φ25	φ28	φ30	φ32	φ36	φ40
Typ. embedment depth [mm]	80	90	110	125	125	170	210	270	285	300	330	360
Base material thickness [mm]	110	120	140	161	165	220	274	340	359	380	420	470

For hammer drilled holes, hollow drill bit¹⁾ and diamond cored with roughening tool²⁾:

- 1) Hilti hollow drill bit available for element size φ12-φ28.
- 2) Roughening tools are available for element size φ14-φ28.

Characteristic resistance

Anchor- size	ETA-16/0143, issue 2017-07-12										Hilti technical data		
	φ8	φ10	φ12	φ14	φ16	φ20	φ25	φ28	φ30	φ32	φ36	φ40	
Non-cracked concrete													
Tensile N_{Rk} B500B	[kN]	-	39,6	58,1	70,6	70,6	111,9	153,7	224,0	249,4	262,4	302,7	344,9
Shear V_{Rk} B500B		-	22,0	31,0	42,0	55,0	86,0	135,0	169,0	194,0	221,0	280,0	346,0
Cracked concrete													
Tensile N_{Rk} B500B	[kN]	-	24,0	39,4	50,3	50,3	79,8	109,6	159,7	177,8	187,1	-	-
Shear V_{Rk} B500B		-	22,0	31,0	42,0	55,0	86,0	135,0	169,0	194,0	221,0	-	-

- 1) Hilti hollow drill bit available for element size φ12-φ28.
- 2) Roughening tools are available for element size φ14-φ28.

Design resistance

Anchor- size	ETA-16/0143, issue 2017-07-12										Hilti technical data		
	φ8	φ10	φ12	φ14	φ16	φ20	φ25	φ28	φ30	φ32	φ36	φ40	
Non-cracked concrete													
Tensile N_{Rd} B500B	[kN]	-	26,4	38,7	47,1	47,1	74,6	102,5	149,4	166,3	174,9	168,2	191,6
Shear V_{Rd} B500B		-	14,7	20,7	28,0	36,7	57,3	90,0	112,7	129,3	147,3	186,7	230,7
Cracked concrete													
Tensile N_{Rd} B500B	[kN]	-	16,0	26,3	33,5	33,5	53,2	73,0	106,5	118,5	124,7	-	-
Shear V_{Rd} B500B		-	14,7	20,7	28,0	36,7	57,3	90,0	112,7	129,3	147,3	-	-

- 1) Hilti hollow drill bit available for element size φ12-φ28.
- 2) Roughening tools are available for element size φ14-φ28.

Recommended loads³⁾

Anchor- size		ETA-16/0143, issue 2017-07-12										Hilti technical data		
		φ8	φ10	φ12	φ14	φ16	φ20	φ25	φ28	φ30	φ32	φ36	φ40	
Non-cracked concrete														
Tensile N _{Rec}	B500B	[kN]	-	18,8	27,6	33,6	33,6	53,3	73,2	106,7	115,7	125,0	120,1	136,9
Shear V _{Rec}	B500B		-	10,5	14,8	20,0	26,2	41,0	64,3	80,5	92,4	105,2	133,3	164,6
Cracked concrete														
Tensile N _{Rec}	B500B	[kN]	-	11,4	18,8	24,0	24,0	38,0	52,2	76,1	84,7	89,1	-	-
Shear V _{Rec}	B500B		-	10,5	14,8	20,0	26,2	41,0	64,3	80,5	92,4	105,2	-	-

1) Hilti hollow drill bit available for element size φ12-φ28.

2) Roughening tools are available for element size φ14-φ28.

3) With overall partial safety factor for action $\gamma=1,4$. The partial safety factors for action depend on the type of loading and shall be taken from national regulations.

For diamond cored holes:

Characteristic resistance

Anchor- size		ETA-16/0143, issue 2017-07-12										
		φ8	φ10	φ12	φ14	φ16	φ20	φ25	φ28	φ30	φ32	
Tensile N _{Rk}	B500B	[kN]	-	25,4	37,3	49,5	56,5	96,1	148,4	224,0	249,4	262,4
Shear V _{Rk}	B500B		-	22,0	31,0	42,0	55,0	86,0	135,0	169,0	194,0	221,0

Design resistance

Anchor- size		ETA-16/0143, issue 2017-07-12										
		φ8	φ10	φ12	φ14	φ16	φ20	φ25	φ28	φ30	φ32	
Tensile N _{Rd}	B500B	[kN]	-	14,1	20,7	27,5	26,9	45,8	70,7	106,7	115,7	125,0
Shear V _{Rd}	B500B		-	14,7	20,7	28,0	36,7	57,3	90,0	112,7	129,3	147,3

Recommended loads^{a)}

Anchor- size		ETA-16/0143, issue 2017-07-12										
		φ8	φ10	φ12	φ14	φ16	φ20	φ25	φ28	φ30	φ32	
Tensile N _{Rec}	B500B	[kN]	-	10,1	14,8	19,6	19,2	32,7	50,5	76,2	82,6	89,3
Shear V _{Rec}	B500B		-	10,5	14,8	20,0	26,2	41,0	64,3	80,5	92,4	105,2

a) With overall partial safety factor for action $\gamma=1,4$. The partial safety factors for action depend on the type of loading and shall be taken from national regulations.

Seismic loading (for a single anchor)

All data in this section applies to:

- Design according to TR 045
- Correct setting (See setting)
- No edge distance and spacing influence
- Steel failure
- Minimum base material thickness
- Concrete C 20/25, $f_{ck,cube} = 25 \text{ N/mm}^2$
- Rebar B450C
- Temperate range I
(min. base material temperature -40°C , max. long term/short term base material temperature: $+24^\circ\text{C}/40^\circ\text{C}$)
- Installation temperature range -5°C to $+40^\circ\text{C}$
- $\alpha_{gap} = 1,0$

For hammer drilled holes:

Embedment depth and base material thickness in case of seismic performance category C2

Anchor- size	$\phi 8$	$\phi 10$	$\phi 12$	$\phi 14$	$\phi 16$	$\phi 20$	$\phi 25$	$\phi 28$	$\phi 30$	$\phi 32$	$\phi 36$	$\phi 40$
Typical embedment depth [mm]	-	-	-	-	125	170	210	-	-	-	-	-
Base material thickness [mm]	-	-	-	-	165	220	274	-	-	-	-	-

Characteristic resistance in case of seismic performance category C2¹⁾

Anchor- size	$\phi 8$	$\phi 10$	$\phi 12$	$\phi 14$	$\phi 16$	$\phi 20$	$\phi 25$	$\phi 28$	$\phi 30$	$\phi 32$	$\phi 36$	$\phi 40$
Tensile $N_{Rk, seis}$ B450C [kN]	-	-	-	-	24,5	45,9	57,7	-	-	-	-	-
Shear $V_{Rk, seis}$ B450C [kN]	-	-	-	-	16,7	29,7	40,7	-	-	-	-	-

1) Hilti technical data.

Design resistance in case of seismic performance category C2¹⁾

Anchor- size	$\phi 8$	$\phi 10$	$\phi 12$	$\phi 14$	$\phi 16$	$\phi 20$	$\phi 25$	$\phi 28$	$\phi 30$	$\phi 32$	$\phi 36$	$\phi 40$
Tensile $N_{Rd, seis}$ B450C [kN]	-	-	-	-	16,3	30,6	38,5	-	-	-	-	-
Shear $V_{Rd, seis}$ B450C [kN]	-	-	-	-	13,3	23,7	32,5	-	-	-	-	-

1) Hilti technical data.

For hammer drilled holes, hollow drill bit²⁾ and diamond cored with roughening tool³⁾:

Embedment depth and base material thickness in case of seismic performance category C1

Anchor- size	$\phi 8$	$\phi 10$	$\phi 12$	$\phi 14$	$\phi 16$	$\phi 20$	$\phi 25$	$\phi 28$	$\phi 30$	$\phi 32$	$\phi 36$	$\phi 40$
Typical embedment depth [mm]	-	90	110	125	125	170	210	270	285	300	-	-
Base material thickness [mm]	-	120	140	161	165	220	274	340	359	380	-	-

Characteristic resistance in case of seismic performance category C1

Anchor- size	$\phi 8$	$\phi 10$	$\phi 12$	$\phi 14$	$\phi 16$	$\phi 20$	$\phi 25$	$\phi 28$	$\phi 30$	$\phi 32$	$\phi 36$	$\phi 40$
Tensile $N_{Rk, seis}$ B500B [kN]	-	22,6	35,3	42,8	42,8	67,8	93,1	135,8	151,1	159,0	-	-
Shear $V_{Rk, seis}$ B500B [kN]	-	22,0	31,0	42,0	55,0	86,0	135,0	169,0	194,0	221,0	-	-

1) Hilti hollow drill bit available for element size $\phi 12$ - $\phi 28$.

2) Roughening tools are available for element size $\phi 14$ - $\phi 28$.

Design resistance in case of seismic performance category C1

Anchor- size	$\phi 8$	$\phi 10$	$\phi 12$	$\phi 14$	$\phi 16$	$\phi 20$	$\phi 25$	$\phi 28$	$\phi 30$	$\phi 32$	$\phi 36$	$\phi 40$
Tensile $N_{Rd, seis}$ B500B [kN]	-	15,1	23,5	28,5	28,5	45,2	62,1	90,5	100,7	106,0	-	-
Shear $V_{Rd, seis}$ B500B [kN]	-	14,7	20,7	28,0	36,7	57,3	90,0	112,7	129,3	147,3	-	-

2) Hilti hollow drill bit available for element size $\phi 12$ - $\phi 28$.

3) Roughening tools are available for element size $\phi 14$ - $\phi 28$.

Materials

Mechanical properties

Anchor size		φ8	φ10	φ12	φ14	φ16	φ20	φ25	φ28	φ30	φ32	φ36	φ40
Nominal tensile strength f_{uk}	B500B [N/mm ²]	550	550	550	550	550	550	550	550	550	550	550	550
	B450C	-	-	-	-	518	518	518	-	-	-	-	-
Yield strength f_{yk}	B500B [N/mm ²]	500	500	500	500	500	500	500	500	500	500	500	500
	B450C	-	-	-	-	450	450	450	-	-	-	-	-
Stressed cross-section A_s	B500B [mm ²]	50,3	78,5	113,1	153,9	201,1	314,2	490,9	615,8	706,9	804,2	1018	1257
	B450C	-	-	-	-	201,1	314,2	490,9	-	-	-	-	-
Moment of resistance W	B500B [mm ³]	50,3	98,2	169,6	269,4	402,1	785,4	1534	2155	2650	3217	4580	6283
	B450C	-	-	-	-	402,1	785,4	1534	-	-	-	-	-

Material quality

Part	Material
Rebar EN 1992-1-1:2004 and AC:2010	Bars and de-coiled rods class B or C with f_{yk} and k according to NDP or NCL of EN 1992-1-1/ NA:2013 $f_{uk} = f_{tk} = k \cdot f_{yk}$

Setting information

Installation temperature range:

-5°C to +40°C

Service temperature range

Hilti HIT-RE 500 V3 injection mortar may be applied in the temperature ranges given below. An elevated base material temperature may lead to a reduction of the design bond resistance.

Temperature range	Base material temperature	Max. long term base material temperature	Max. short term base material temperature
Temperature range I	-40 °C to + 40 °C	+ 24 °C	+ 40 °C
Temperature range II	-40 °C to + 70 °C	+ 43 °C	+ 70 °C

Max. short term base material temperature

Short term elevated base material temperatures are those that occur over brief intervals, e.g. as a result of diurnal cycling.

Max. long term base material temperature

Long term elevated base material temperatures are roughly constant over significant periods of time.

Working time and curing time

Temperature of the base material	Max. working time in which rebar can be inserted and adjusted t_{gel}	Min. curing time before rebar can be fully loaded $t_{cure}^{1)}$
$-5\text{ °C} \leq T_{BM} < -1\text{ °C}$	2 h	168 h
$0\text{ °C} \leq T_{BM} < 4\text{ °C}$	2 h	48 h
$5\text{ °C} \leq T_{BM} < 9\text{ °C}$	2 h	24 h
$10\text{ °C} \leq T_{BM} < 14\text{ °C}$	1,5 h	16 h
$15\text{ °C} \leq T_{BM} < 19\text{ °C}$	1 h	12 h
$20\text{ °C} \leq T_{BM} < 24\text{ °C}$	30 min	7 h
$25\text{ °C} \leq T_{BM} < 29\text{ °C}$	20 min	6 h
$30\text{ °C} \leq T_{BM} < 34\text{ °C}$	15 min	5 h
$35\text{ °C} \leq T_{BM} < 39\text{ °C}$	12 min	4,5 h
$T_{BM} = 40\text{ °C}$	10 min	4 h

1) The curing time data are valid for dry base material only. In wet base material the curing times must be doubled.

Installation equipment

Rebar – size	φ8	φ10	φ12	φ14	φ16	φ20	φ25	φ28	φ30	φ32	φ36	φ40
Rotary hammer	TE 2 (-A) – TE 40(-A)						TE40 – TE80					
Diamond coring tools	DD EC-1, DD 100 ... DD 160 ^{a)}											
Other tools	Compressed air gun, brush, hollow drill bit, roughening tool, dispenser, piston plug											

a) For anchors in diamond drilled holes, load values for combined pull-out and concrete cone resistance have to be reduced (see section "Setting instruction")

Associated components for the use of Hilti Roughening tool TE-YRT

Diamond coring		Roughening tool TE-YRT	Wear gauge RTG...
d _o [mm]		d _o [mm]	size
Nominal	measured		
18	17,9 to 18,2	18	18
20	19,9 to 20,2	20	20
22	21,9 to 22,2	22	22
25	24,9 to 25,2	25	25
28	27,9 to 28,2	28	28
30	29,9 to 30,2	30	30
32	31,9 to 32,2	32	32
35	34,9 to 35,2	35	35

Minimum roughening time t_{roughen} ($t_{\text{roughen}} [\text{sec}] = h_{\text{ef}} [\text{mm}] / 10$)

$h_{\text{ef}} [\text{mm}]$	$t_{\text{roughen}} [\text{sec}]$
0 to 100	10
101 to 200	20
201 to 300	30
301 to 400	40
401 to 500	50
501 to 600	60

Setting details

Anchor size		Ø8	Ø10	Ø12		Ø14	Ø16	Ø20	Ø25	Ø28	Ø30	Ø32	Ø36	Ø40
Nominal diameter of drill bit	d_0 [mm]	10 12 ^{a)}	12 14 ^{a)}	14 ^{a)}	16 ^{a)}	18	20	25	30 32 ^{a)}	35	37	40	45 ¹⁾	55 ¹⁾
Effective anchorage and drill hole depth	$h_{ef,min}$ [mm]	60	60	70	70	75	80	90	100	112	120	128	144 ¹⁾	160 ¹⁾
	$h_{ef,max}$ [mm]	160	200	240	240	280	320	400	500	560	600	640	720 ¹⁾	800 ¹⁾
Minimum base material thickness	h_{min} [mm]	$h_{ef} + 30\text{mm}$ $\geq 100\text{ mm}$				$h_{ef} + 2 d_0$								
Minimum spacing	s_{min} [mm]	40	50	60	60	70	80	100	125	140	150	160	180 ¹⁾	200 ¹⁾
Minimum edge	c_{min} [mm]	40	45	45	45	50	50	65	70	75	80	80	180 ¹⁾	200 ¹⁾
Critical spacing for splitting failure	$s_{cr,sp}$ [mm]	$2 C_{cr,sp}$												
Critical edge distance for splitting failure ^{c)}	$c_{cr,sp}$ [mm]	$1,0 \cdot h_{ef}$ for $h / h_{ef} \geq 2,0$												
		$4,6 h_{ef} - 1,8 h$ for $2,0 > h / h_{ef} > 1,3$												
		$2,26 h_{ef}$ for $h / h_{ef} \leq 1,3$												
Critical spacing for concrete cone failure	$s_{cr,N}$ [mm]	$2 C_{cr,N}$												
Critical edge distance for concrete cone failure ^{d)}	$c_{cr,N}$ [mm]	$1,5 h_{ef}$												

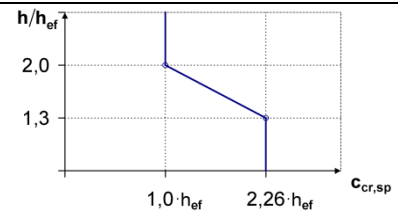

1) Additional Hilti Technical data

For spacing (edge distance) smaller than critical spacing (critical edge distance) the design loads have to be reduced.

- a) both given values for drill bit diameter can be used
- b) $h_{ef,min} \leq h_{ef} \leq h_{ef,max}$ (h_{ef} : embedment depth)
- c) h : base material thickness ($h \geq h_{min}$)
- d) The critical edge distance for concrete cone failure depends on the embedment depth h_{ef} and the design bond resistance. The simplified formula given in this table is on the safe side

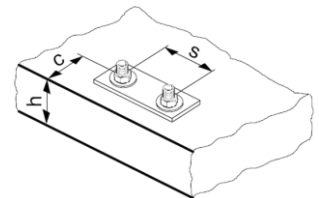

Concrete
Chemical anchors
Mechanical anchors
Plastic/Light duty metal anchors
Insulation anchors

Drilling and cleaning diameters

Rebar - size	Hammer drill (HD)	Hollow Drill Bit (HDB)	Diamond coring		Brush HIT-RB	Piston plug HIT-SZ
			Diamond coring (DD)	With roughening tool (RT)		
	d ₀ [mm]				size [mm]	
φ8	12 (10 ^a)	-	12 (10 ^a)	-	12 (10 ^a)	12
φ10	14 (12 ^a)	14	14 (12 ^a)	-	14 (12 ^a)	14 (12 ^a)
φ12	16 (14 ^a)	16 (14 ^a)	16 (14 ^a)	-	16 (14 ^a)	16 (14 ^a)
φ14	18	18	18	18	18	18
φ16	20	20	20	20	20	20
φ20	25	25	25	25	25	25
φ25	32	32	32	32	32	32
φ28	35	35	35	35	35	35
φ30	37	-	37	-	37	37
φ32	40	-	-	-	40	40
	-	-	42	-	42	42
φ36	45 ^b)	-	-	-	45 ^b)	45 ^b)
φ40	55 ^b)	-	-	-	55 ^b)	55 ^b)

- a) Each of two given values can be used
b) Additional Hilti technical data

Setting instructions

*For detailed information on installation see instruction for use given with the package of the product.



Safety regulations.

Review the Material Safety Data Sheet (MSDS) before use for proper and safe handling! Wear well-fitting protective goggles and protective gloves when working with Hilti HIT-RE 500 V3.

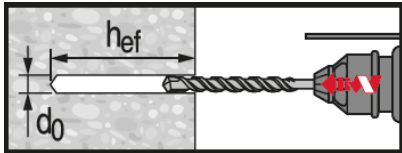

Hammer drilled hole

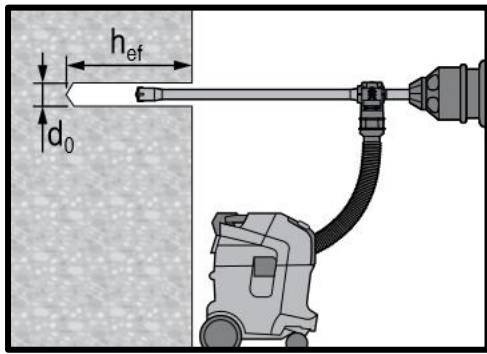

Hammer drilled hole with Hollow Drilled Bit (HDB)

No cleaning required

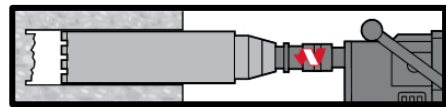

Diamond Coring

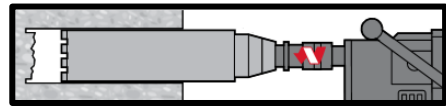

Diamond Coring + Roughening Tool

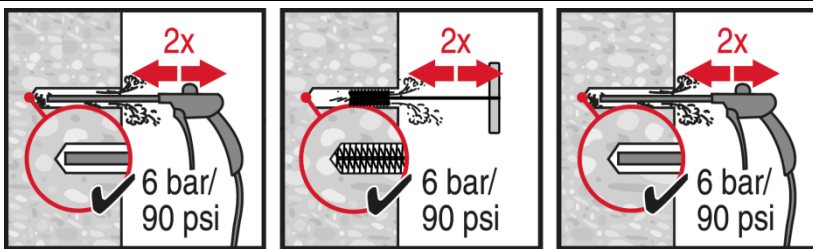
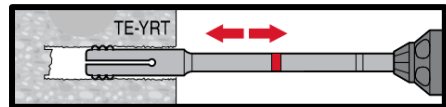

Hammer Drilling:

Compressed air cleaning (CAC)

for all drill hole diameters d_0 and drill hole depths $h_0 \leq 20 \cdot d_0$.

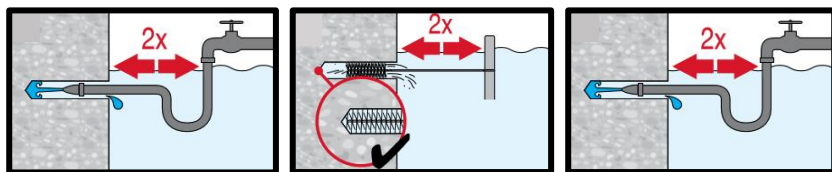

Hammer drilling:

Cleaning for under water:

For all bore hole diameters d_0 and all bore hole depth h_0 .

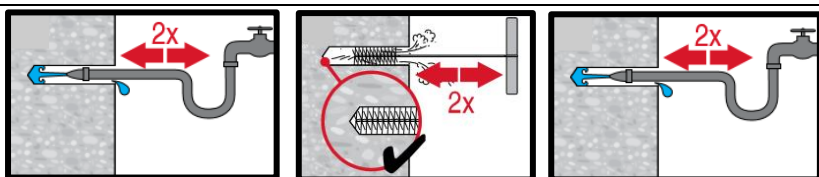

Hammer drilled flooded holes and diamond cored holes:

Compressed air cleaning (CAC)

for all drill hole diameters d_0 and drill hole depths h_0 .

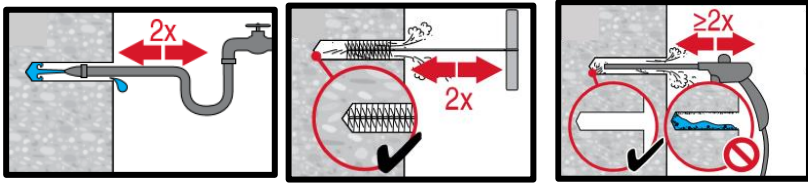
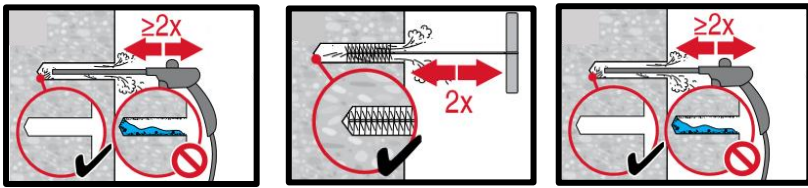

Diamond cored holes with Hilti roughening tool:

Compressed air cleaning (CAC) for all drill hole diameters d_0 and drill hole depths h_0 .

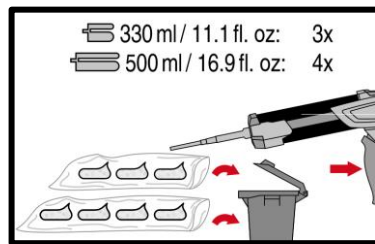
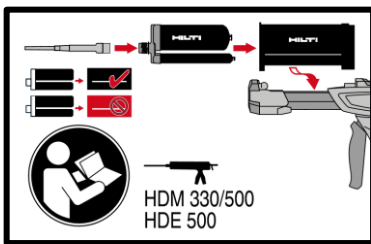

Injection system preparation.

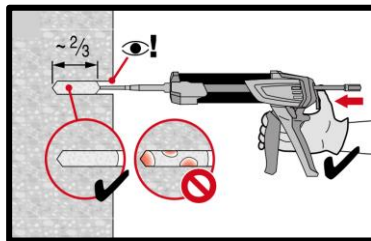
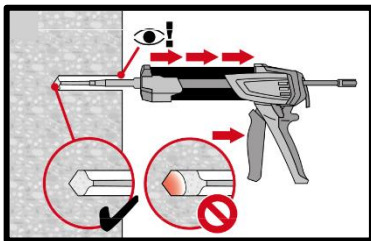

Injection method for drill hole depth
 $h_{ef} \leq 250$ mm.

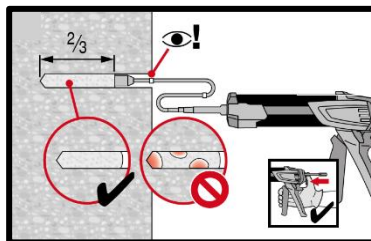
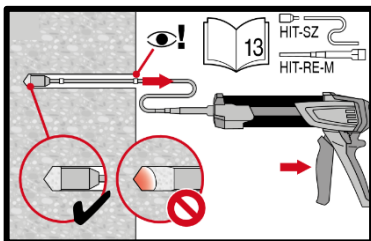

Injection method for drill hole depth
 $h_{ef} > 250$ mm.

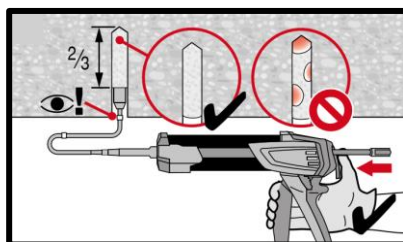
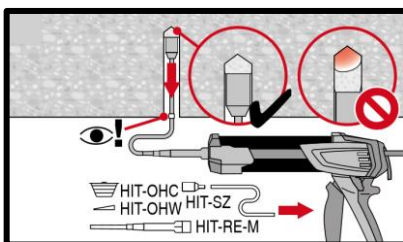

Injection method for overhead application.

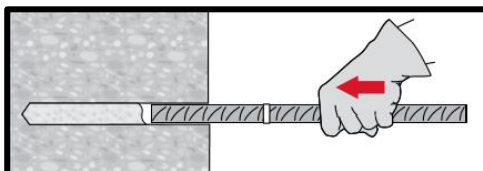

Setting element, observe working time " t_{work} ",

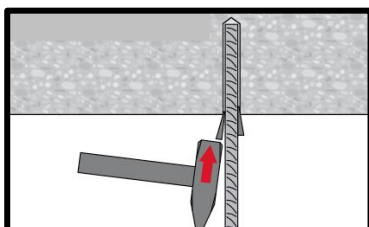

Setting element for overhead applications, observe working time " t_{work} ",

Loading the anchor: After required curing time t_{cure} the anchor can be loaded.

HIT-RE 500 V3 injection mortar

Rebar design (EN 1992-1) / Rebar elements / Concrete

Concrete

Chemical anchors

Mechanical anchors

Plastic/Light duty metal anchors

Insulation anchors

Injection mortar system



Foil pack: HIT-RE 500 V3
(available in 330, 500 and 1400 ml cartridges)



Rebar B500 B
($\phi 8 - \phi 40$)

Benefits

- **SafeSet** technology: Simplified method of borehole preparation using either Hilti hollow drill bit for hammer drilling or Roughening tool for diamond cored applications
- Suitable for concrete C 12/15 to C 50/60
- High loading capacity
- Suitable for dry and water saturated concrete
- Non-corrosive to rebar elements
- Long working time at elevated temperatures
- Cures down to -5°C
- Odourless epoxy
- Fire time exposure up to 4h

Base material



Concrete (non-cracked)



Concrete (cracked)



Dry concrete

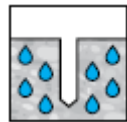

Wet concrete

Load conditions

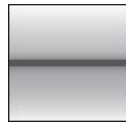

Static/quasi-static



Seismic, ETA-C1



Fire resistance

Installation conditions

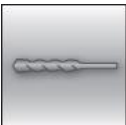

Hammer drilling



Diamond coring

SAFESET

Hilti **SafeSet** technology



European Technical Assessment



CE conformity



PROFIS Rebar design Software

Approvals / certificates

Description	Authority / Laboratory	No. / date of issue
European technical assessment ^{a)}	CSTB, Marne la Vallée	ETA-16/0142 / 2018-07-04
Fire evaluation	CSTB, Marne la Vallée	MRF 1526054277/B

b) All data given in this section according to ETA-16/0142 issue 2018-07-04.

Static and quasi-static loading

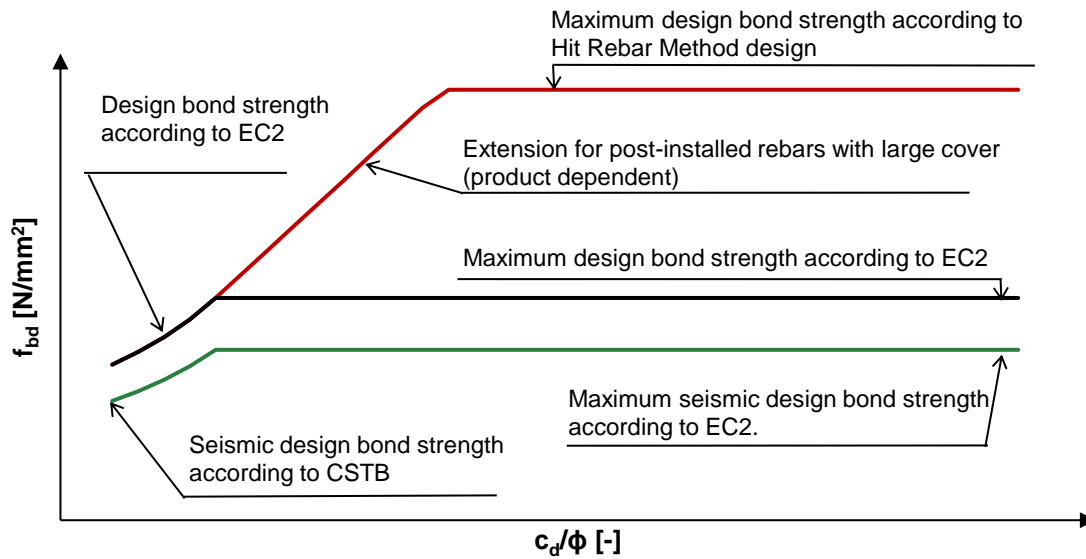

Effective limit on bond stress for post-installed rebar using Hilti mortar systems and design bond strength values as provided by the EC2.

Static EC2 design, small concrete cover (see section 3.2.1)

Design bond strength in N/mm² according to ETA 16/0142 for good bond conditions

All allowed hammer drilling methods									
Rebar - size	Concrete class								
	C12/15	C16/20	C20/25	C25/30	C30/37	C35/45	C40/50	C45/55	C50/60
φ8 - φ32	1,6	2,0	2,3	2,7	3,0	3,4	3,7	4,0	4,3
φ36	1,6	1,9	2,2	2,6	2,9	3,2	3,5	3,8	4,1
φ40	1,5	1,8	2,1	2,5	2,8	3,1	3,4	3,7	3,9
Diamond coring wet									
φ8 - φ12	1,6	2,0	2,3	2,7	3,0	3,4	3,7	4,0	4,0
φ14 - φ16	1,6	2,0	2,3	2,7	3,0	3,4	3,7	3,7	3,7
φ20 - φ32	1,6	2,0	2,3	2,7	3,0	3,4	3,4	3,4	3,4
φ36	1,6	2,0	2,2	2,6	2,9	3,2	3,2	3,2	3,2
φ40	1,6	2,0	2,1	2,5	2,8	2,8	2,8	2,8	2,8

For poor bond conditions multiply the values by 0,7.

Static Hit Rebar design method, large concrete cover (see section 3.2.2)

Pullout design bond strength [$f_{bd,po} = T_{RK}/\gamma_{Mp}$] in N/mm² for good bond conditions

Non-cracked concrete C20/25, all allowed drilling methods

Temperature range	Drilling method	Rebar - size											
		φ8	φ10	φ12	φ14	φ16	φ20	φ25	φ28	φ30	φ32	φ36	φ40
I: 40°C/24° C	Hammer drilled holes	6,3	9,5	9,5	9,5	9,5	9,5	8,7	8,7	8,7	8,7	6,7	7,9
	Hammer drilled holes with hollow drill bit	-	-	9,5	9,5	9,5	9,5	8,7	8,7	-	-	-	-
	Diamond cored holes with roughening tool	-	-	-	9,5	9,5	9,5	8,7	8,7	-	-	-	-
	Diamond cored holes	5	5	5	5	5	5	5	5,3	5,3	5,3	-	-
	Hammer drilled holes in water filled holes	3,8	5,7	5,7	5,7	5,7	5,7	5,2	5,2	5,2	5,2	-	-
II: 70°C/43° C	Hammer drilled holes	4,7	7,3	7,3	7,3	6,7	6,7	6,7	6,3	6,3	6,3	5,7	5,0
	Hammer drilled holes with hollow drill bit	-	-	7,3	7,3	6,7	6,7	6,7	6,3	-	-	-	-
	Diamond cored holes with roughening tool	-	-	-	7,3	6,7	6,7	6,7	6,3	-	-	-	-
	Diamond cored holes	3,6	3,6	3,6	3,6	3,1	3,3	3,3	3,3	3,3	3,3	-	-
	Hammer drilled holes in water filled holes	2,6	4,3	4,3	4,3	4,3	4,0	4,0	4,0	3,8	3,8	-	-
Cracked concrete C20/25, all allowed drilling methods													
I: 40°C/24° C	Hammer drilled holes	3	5,7	6,3	6,3	6,3	6,7	6,7	7,3	7,3	7,3		
	Hammer drilled holes with hollow drill bit	-	-	6,3	6,3	6,3	6,7	6,7	7,3	-	-	-	-
	Diamond cored holes with roughening tool	-	-	-	6,3	6,3	6,7	6,7	7,3	-	-	-	-
II: 70°C/43° C	Hammer drilled holes	2,7	4,7	5,3	5,3	5,3	5,3	5,3	5,3	5,3	5,3		
	Hammer drilled holes with hollow drill bit	-	-		5,3	5,3	5,3	5,3	5,3	-	-	-	-
	Diamond cored holes with roughening tool	-	-	-	5,3	5,3	5,3	5,3	5,3	-	-	-	-

For poor bond conditions multiply values by 0,7.

Increasing factors in concrete for $f_{bd,po}$

Dilling method	Concrete class	Rebar-size											
		φ8	φ10	φ12	φ14	φ16	φ20	φ25	φ28	φ30	φ32	φ36	φ40
Hammer drilled holes	C 30/37	1,04											
Hammer drilled holes with hollow drill bit	C40/50	1,07											
Diamond cored holes	C50/60	1,09											
Diamond cored holes with roughening tool	C 30/37 - C50/60	1,0										-	

Minimum anchorage length and minimum lap length

The minimum anchorage length $\ell_{b,min}$ and the minimum lap length $\ell_{0,min}$ according to EN 1992-1-1 shall be multiplied by relevant **Amplification factor** α_{lb} in the table below.

Amplification factor α_{lb} for the min. anchorage length and min. lap length

All allowed hammer drilling methods									
Rebar - size	Concrete class								
	C12/15	C16/20	C20/25	C25/30	C30/37	C35/45	C40/50	C45/55	C50/60
$\phi 8 - \phi 40$	1,0								
Diamond coring dry and wet									
$\phi 8 - \phi 12$	1,0								
$\phi 14 - \phi 36$	Linear interpolation between diameter								
$\phi 40$	1,0	1,0	1,0	1,0	1,2	1,3	1,4	1,4	1,4

Anchorage length for characteristic steel strength $f_{yk}=500 \text{ N/mm}^2$ for good conditions

Hammer drilling									
Rebar-size	Concrete class	f_{bd}	$f_{bd,p}$	$\ell_{0,min}^{1)}$	$\ell_{b,min}^{2)}$	$\ell_{bd,y,\alpha_2=1}^{3)}$	$\ell_{bd,y,\alpha_2=0.7}^{4)}$	$\ell_{bd,y,HRM,\alpha_2<0.7}^{5)}$	$\ell_{max}^{6)}$
		[N/mm ²]	[N/mm ²]	[mm]	[mm]	[mm]	[mm]	[mm]	[mm]
$\phi 8$	C20/25	2,3	6,3	200	113	378	265	138	1000
	C50/60	4,3	6,9	200	100	202	142	126	1000
$\phi 10$	C20/25	2,3	9,3	213	142	473	331	142	1000
	C50/60	4,3	10,2	200	100	253	177	107	1000
$\phi 12$	C20/25	2,3	9,3	255	170	567	397	170	1200
	C50/60	4,3	10,2	200	120	303	212	128	1200
$\phi 14$	C20/25	2,3	9,3	298	198	662	463	198	1400
	C50/60	4,3	10,2	210	140	354	248	149	1400
$\phi 16$	C20/25	2,3	9,3	340	227	756	529	234	1600
	C50/60	4,3	10,2	240	160	404	283	171	1600
$\phi 20$	C20/25	2,3	9,3	435	284	945	662	356	2000
	C50/60	4,3	10,2	300	200	506	354	213	2000
$\phi 25$	C20/25	2,3	8,7	532	354	1181	827	539	2500
	C50/60	4,3	9,4	375	250	632	442	289	2500
$\phi 28$	C20/25	2,3	8,7	595	397	1323	926	663	2800
	C50/60	4,3	9,4	420	280	708	495	354	2800
$\phi 30$	C20/25	2,3	8,7	638	425	1418	992	751	3000
	C50/60	4,3	9,4	450	300	758	531	402	3000
$\phi 32$	C20/25	2,3	8,7	681	454	1512	1059	844	3200
	C50/60	4,3	9,4	480	320	809	566	451	3200
$\phi 36$	C20/25	2,2	5,2	534	540	1779	1245	753	3200
	C50/60	3,2	5,7	367	540	1223	856	686	3200
$\phi 40$	C20/25	2,1	4,8	621	621	2070	1449	906	3200
	C50/60	2,8	5,2	466	600	1553	1087	836	3200

- 1) Minimum anchorage length for overlap joint
- 2) Minimum anchorage length for simply supported connections
- 3) Anchorage length for simply supported connections in case of: $\alpha_1 = \alpha_2 = \alpha_3 = \alpha_4 = \alpha_5 = 1$. - (design for yielding)
- 4) Anchorage length for simply supported connections in case of: $\alpha_1 = \alpha_3 = \alpha_4 = \alpha_5 = 1$; $\alpha_2 = 0.7$ - (design for yielding)
- 5) Anchorage length with HIT Rebar design Method (HRM) for simply supported connections in case of: $\alpha_1 = \alpha_3 = \alpha_4 = \alpha_5 = 1$; $\alpha_2 < 0.7$. Only if an adequate concrete cover is applied.
- 6) Maximum feasible embedment depth due to mortar installation limitations.

Seismic loading

Seismic data according to ETA-16/0142

Design bond strength in N/mm² for good bond conditions

All allowed hammer drilling methods and diamond coring with Hilti roughening tool TE-YRT

Rebar - size	Concrete class							
	C16/20	C20/25	C25/30	C30/37	C35/45	C40/50	C45/55	C50/60
φ12 - φ32	2,0	2,3	2,7	3,0	3,4	3,7	4,0	4,3
φ36	1,9	2,2	2,6	2,9	3,2	3,5	3,8	4,1
φ40	1,8	2,1	2,5	2,8	3,1	3,4	3,7	3,9

For poor bond conditions multiply the values 0,7.

Design bond strength in N/mm² for good bond conditions

Values for diamond coring dry and wet

Rebar - size	Concrete class								
	C16/20	C20/25	C25/30	C30/37	C35/45	C40/50	C45/55	C50/60	
φ12	2,0	2,3	2,7	3,0	3,4	3,7	4,0	4,3	
φ14-φ32	2,0								
φ36	1,9	2,0							
φ40	1,8	2,0							

For poor bond conditions multiply the values 0,7.

Fire resistance

Temperature reduction factor $k_{fi}(\theta)$

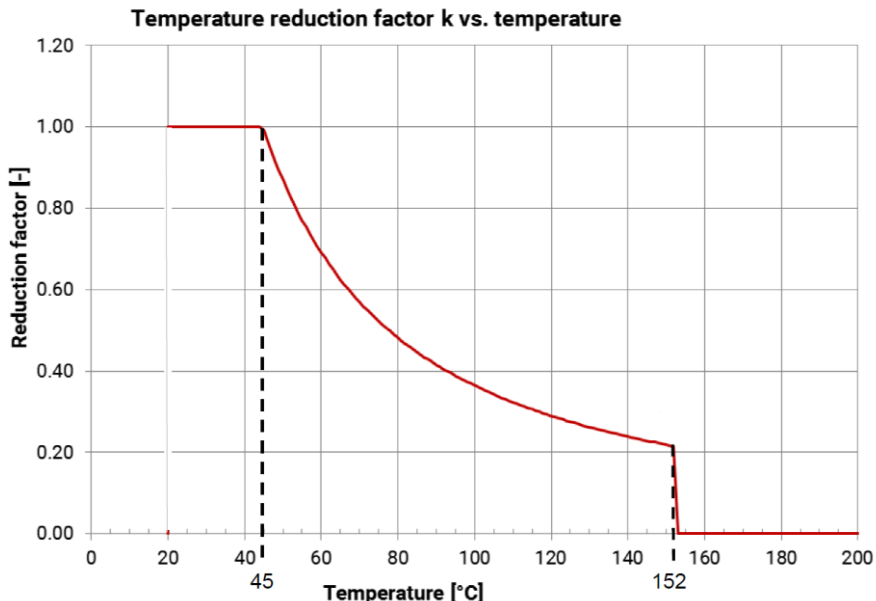

The analytic equation that describe the variation of $k_{fi}(\theta)$ with temperature is given by the following function:

If $45^{\circ}\text{C} \leq \theta \leq 152^{\circ}\text{C}$: $k_{fi}(\theta) = \frac{f_{bm}(\theta)}{f_{bm,rqd,d}} \leq 1,0$ in $^{\circ}\text{C}$
 If $\theta < 45^{\circ}\text{C}$ $k_{fi}(\theta) = 1,0$
 If $\theta > 152^{\circ}\text{C}$ $k_{fi}(\theta) = 0,0$

With:
 $f_{bm}(\theta) = 1178,2 \cdot \theta^{-1,255}$ in $^{\circ}\text{C}$

According to MRF 1526054277 / B

a) Anchoring application

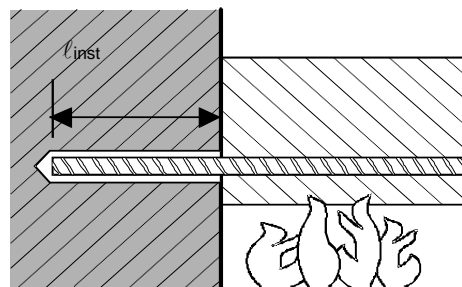

Anchoring application beam-wall connection with a concrete cover of 20 mm

Maximum force in rebar in conjunction with HIT-RE 500 V3 as a function of embedment depth for the fire resistance classes F30 to F240 (yield strength $f_{yk} = 500 \text{ N/mm}^2$ and concrete class C20/25) according EC2

Rebar-size	Max. $F_{s,T}$ [kN]	l_{inst} [mm]	Fire resistance of bar in [kN]					
			R30	R60	R90	R120	R180	R240
$\phi 8$	16,8	100	3,8	1,3	0,5	0,2	0,0	0,0
		140	7,2	4,3	2,3	1,5	0,7	0,2
		180	10,7	7,8	5,6	3,9	2,1	1,3
		220	14,2	11,2	9,1	7,4	4,6	2,9
		250	16,8	13,8	11,7	10,0	7,1	4,8
		290		16,8	15,1	13,5	10,6	8,1
		310	16,8		16,8	15,2	13,5	10,6
		330		16,8		16,8	15,2	13,5
		370	16,8	16,8	16,8	16,8	14,0	11,6
		390	16,8	16,8	16,8	16,8	16,8	16,8

Maximum force in rebar in conjunction with HIT-RE 500 V3 as a function of embedment depth for the fire resistance classes F30 to F240 (yield strength $f_{yk} = 500 \text{ N/mm}^2$ and concrete class C20/25) according EC2

Rebar-size	Max. $F_{s,T}$ [kN]	l_{inst} [mm]	Fire resistance of bar in [kN]							
			R30	R60	R90	R120	R180	R240		
$\phi 10$	26,2	110	5,8	2,4	1,1	0,6	0,0	0,0		
		150	10,1	6,5	3,8	2,5	1,2	0,5		
		190	14,5	10,8	8,1	6,0	3,3	2,0		
		230	18,8	15,1	12,4	10,3	6,7	4,4		
		300	26,2	26,2	22,7	20,0	17,9	14,3	11,2	
		340			24,3	22,2	18,6	15,6		
		360			26,2	24,4	20,8	17,7		
		380				26,2	23,0	19,9		
		410			26,2		23,1			
		440			26,2		26,2			
$\phi 12$	37,7	140			10,9	6,5	3,5	2,3	1,0	0,3
		200			18,7	14,3	11,0	8,5	4,8	3,0
		260			26,5	22,1	18,8	16,3	12,0	8,3
		320			34,3	29,9	26,6	24,1	19,8	16,1
		350	37,7	37,7	33,8	30,5	28,0	23,7	20,0	
		390			35,7	33,2	28,9	25,2		
		410			37,7	35,8	31,5	27,8		
		430				37,7	34,1	30,4		
		460			37,7		34,3			
		490			37,7		37,7			
$\phi 14$	51,3	160			15,7	10,6	6,7	4,4	2,3	1,1
		220			24,8	19,7	15,8	12,9	8,0	5,1
		280			33,9	28,8	24,9	22,0	17,0	12,7
		340			43,0	37,9	34,1	31,1	26,1	21,8
		400	51,3	51,3	47,0	43,2	40,2	35,2	30,9	
		430			47,7	44,8	39,7	35,4		
		460			51,3	49,3	44,3	40,0		
		480				51,3	47,3	43,0		
		510			51,3		47,6			
		540			51,3		51,3			
$\phi 16$	67	180			21,4	15,5	11,2	7,8	4,3	2,5
		240			31,8	25,9	21,6	18,2	12,5	8,2
		300			42,2	36,3	32,0	28,6	22,9	18,0
		360			52,6	46,8	42,4	39,0	33,3	28,4
		450	67,0	67,0	62,4	58,0	54,6	48,9	44,0	
		480			63,2	59,8	54,1	49,2		
		510			67,0	65,1	59,3	54,4		
		530				67,0	62,8	57,8		
		560			67,0		63,0			
		590			67,0		67,0			
$\phi 20$	104,7	220			35,5	28,1	22,6	18,5	11,4	7,3
		280			48,5	41,1	35,6	31,5	24,3	18,1
		340			61,5	54,1	48,6	44,5	37,3	31,1
		400			74,5	67,1	61,7	57,5	50,3	44,1
		460	87,5	80,1	74,7	70,5	63,3	57,1		
		540	104,7	104,7	97,5	92,0	87,8	80,6	74,5	
		580			100,7	96,5	89,3	83,1		
		600			104,7	100,8	93,6	87,5		
		620				104,7	98,0	91,8		
		660			104,7		100,5			
		680			104,7		104,7			

Anchoring application beam-wall connection with a concrete cover of 40 mm

Rebar-size	Max. F _{s,T} [kN]	l _{inst} [mm]	Fire resistance of bar in [kN]					
			R30	R60	R90	R120	R180	R240
φ8	16,8	100	4,9	1,8	0,8	0,4	0,0	0,0
		140	8,4	5,0	2,9	1,9	0,7	0,2
		180	11,9	8,5	6,2	4,5	2,3	1,3
		220	15,4	11,9	9,7	8,0	4,9	3,1
		240	16,8	13,7	11,4	9,7	6,6	4,3
		280		16,8	14,9	13,2	10,1	7,6
		310	16,8		16,8	16,8	15,8	12,7
		330		14,4			11,9	
		360		16,8			14,5	
		390					16,8	16,8
φ10	26,2	110	7,3	3,1	1,5	0,9	0,0	0,0
		150	11,6	7,3	4,5	3,0	1,3	0,6
		190	15,9	11,7	8,9	6,7	3,5	2,1
		230	20,3	16,0	13,2	11,0	7,2	4,6
		290	26,2	22,5	19,7	17,5	13,7	10,5
		330		26,2	24,0	21,9	18,0	14,9
		350	26,2		26,2	26,2	24,0	20,2
		370		22,3			19,2	
		410		26,2			23,6	
		440					26,2	26,2
φ12	37,7	140	12,6	7,5	4,3	2,8	1,1	0,3
		200	20,4	15,3	11,9	9,3	5,2	3,2
		260	28,2	23,1	19,7	17,1	12,5	8,8
		320	36,0	30,9	27,6	25,0	20,3	16,6
		340	37,7	33,5	30,2	27,6	22,9	19,2
		380		37,7	35,4	32,8	28,1	24,4
		400	37,7		37,7	37,7	35,4	30,7
		420		33,3			29,6	
		460		37,7			34,8	
		490					37,7	37,7
φ14	51,3	160	17,8	11,8	7,9	5,2	2,5	1,2
		220	26,9	20,9	17,0	13,9	8,5	5,5
		280	36,0	30,0	26,1	23,0	17,6	13,2
		340	45,1	39,1	35,2	32,1	26,7	22,4
		390	51,3	46,7	42,8	39,7	34,3	29,9
		430		51,3	48,8	45,8	40,4	36,0
		450	51,3		51,3	51,3	48,8	43,4
		470		46,4			42,1	
		510		51,3			48,1	
		540					51,3	51,3
φ16	67	180	23,8	16,9	12,5	9,0	4,6	2,7
		240	34,2	27,3	22,9	19,4	13,2	8,7
		300	44,6	37,7	33,3	29,8	23,6	18,6
		360	55,0	48,2	43,7	40,2	34,0	29,0
		430	67,0	60,3	55,8	52,3	46,1	41,2
		470		67,0	62,7	59,3	53,1	48,1
		500	67,0		67,0	67,0	64,5	58,3
		520		61,7			56,8	
		560		67,0			63,7	
		580					67,0	67,0

Concrete

Chemical anchors

Mechanical anchors

Plastic/Light duty metal anchors

Insulation anchors

Rebar-size	Max. F _{s,T} [kN]	l _{inst} [mm]	Fire resistance of bar in [kN]					
			R30	R60	R90	R120	R180	R240
φ20	104,7	220	38,4	29,8	24,2	19,9	12,2	7,8
		300	55,7	47,2	41,6	37,3	29,5	23,3
		380	73,1	64,5	58,9	54,6	46,8	40,6
		460	90,4	81,9	76,3	71,9	64,2	57,9
		530	104,7	97,0	91,4	87,1	79,3	73,1
		570		104,7	100,1	95,8	88,0	81,8
		600	104,7		104,7	102,3	94,5	88,3
		620		104,7		104,7	98,9	92,6
		650	104,7		104,7		104,7	99,1
		680		104,7		104,7	104,7	104,7
φ25	163,6	280	64,2		53,6		46,6	41,1
		370	88,6	77,9	70,9	65,5	55,8	48,0
		460	113,0	102,3	95,3	89,9	80,2	72,4
		550	137,4	126,7	119,7	114,3	104,6	96,8
		650	163,6	153,8	146,8	141,4	131,7	123,9
		690		163,6	157,7	152,2	142,5	134,7
		720	163,6		163,6	160,4	150,7	142,9
		740		163,6		163,6	156,1	148,3
		770	163,6		163,6		163,6	156,4
		800		163,6		163,6	163,6	163,6
φ28	205,3	310	81,1		69,1		61,3	55,2
		370	99,3	87,3	79,5	73,4	62,5	53,8
		430	117,5	105,5	97,7	91,6	80,7	72,0
		490	135,7	123,7	115,9	109,8	98,9	90,2
		550	153,9	141,9	134,1	128,0	117,2	108,4
		610	172,1	160,1	152,3	146,2	135,4	126,6
		670	190,3	178,3	170,5	164,4	153,6	144,8
		720	205,3	193,5	185,7	179,6	168,7	160,0
		760		205,3	197,8	191,8	180,9	172,2
		790	205,3		205,3	200,9	190,0	181,3
		810		205,3		205,3	196,1	187,3
		850	205,3		205,3		205,3	199,5
870	205,3	205,3		205,3		205,3		
φ32			268,1	350	106,5	92,8	83,9	76,9
	410	127,3		113,6	104,7	97,8	85,3	75,4
	470	148,1		134,5	125,5	118,6	106,1	96,2
	530	168,9		155,3	146,3	139,4	127,0	117,0
	590	189,7		176,1	167,1	160,2	147,8	137,8
	650	210,6		196,9	187,9	181,0	168,6	158,6
	710	231,4		217,7	208,7	201,8	189,4	179,4
	820	268,1		255,8	246,9	240,0	227,5	217,6
	860			268,1	260,8	253,8	241,4	231,4
	890	268,1			268,1	264,2	251,8	241,8
	910			268,1		268,1	258,7	248,8
	940	268,1			268,1		268,1	259,2
	970			268,1		268,1	268,1	268,1

b) Overlap joint application

Max. bond stress, $f_{bd,FIRE}$, depending on actual clear concrete cover for classifying the fire resistance.

It must be verified that the actual force in the bar during a fire, $F_{s,T}$, can be taken up by the bar connection of the selected length, l_{inst} . Note: Cold design for ULS is mandatory.

$$F_{s,T} \leq (l_{inst} - c_f) \cdot \phi \cdot \pi \cdot f_{bd,FIRE} \quad \text{where: } (l_{inst} - c_f) \geq l_s;$$

l_s = lap length

ϕ = nominal diameter of bar

$l_{inst} - c_f$ = selected overlap joint length; this must be at least l_s ,

but may not be assumed to be more than 80ϕ

$f_{bd,FIRE}$ = bond stress when exposed to fire

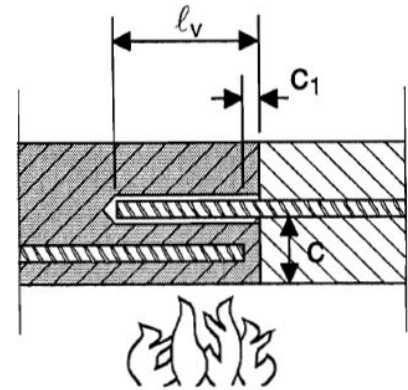

Critical temperature-dependent bond stress, $f_{bd,FIRE}$, concerning “overlap joint” for Hilti HIT-RE 500 V3 injection adhesive in relation to fire resistance class and required minimum concrete coverage c.

Clear concrete cover c [mm]	Max. bond stress, τ_c [N/mm ²]					
	R30	R60	R90	R120	R180	R240
30						
40	0,8					
50	1,1					
60	1,5					
70	2,1	0,9				
80	2,9	1,2				
90	3,5	1,5	0,9			
100		1,8	1,1	0,8		
110		2,3	1,4	1,0		
120		2,8	1,6	1,2		
130		3,4	2,0	1,4	0,9	
140		3,5	2,3	1,6	1,0	
150			2,8	1,9	1,1	0,8
160			3,3	2,2	1,3	0,9
170			3,5	2,5	1,5	1,1
180				2,9	1,7	1,2
190				3,4	1,9	1,4
200				3,5	2,2	1,5
210					2,5	1,7
220					2,8	1,9
230					3,1	2,1
240					3,5	2,3
250						2,6
260						2,9
270						3,2
280						3,5
290						

Materials

Properties of reinforcement

Designation	Material
Reinforcing bars (rebars)	
Rebar EN 1992-1-1	Bars and de-coiled rods class B or C with f_{yk} and k according to NDP or NCL of EN 1992-1-1 $f_{uk} = f_{tk} = k \cdot f_{yk}$

Fitness for use

Some creep tests have been conducted in accordance with ETAG guideline 001 part 5 and TR 023 in the following conditions: **in dry environment at 50 °C during 90 days.**

These tests show an excellent behaviour of the post-installed connection made with HIT-RE 500 V3: low displacements with long term stability, failure load after exposure above reference load.

Resistance to chemical substances

Chemicals tested	Content (%)	Resistance	Chemical tested	Content (%)	Resistance
Toluene	47,5	+	Sodium hydroxide 20%	100	-
Iso-octane	30,4	+	Triethanolamine	50	-
Heptane	17,1	+	Butylamine	50	-
Methanol	3	+	Benzyl alcohol	100	-
Butanol	2	+	Ethanol	100	-
Toluene	60	+	Ethyl acetate	100	-
Xylene	30	+	Methyl ethyl ketone (MEK)	100	-
Methylnaphthalene	10	+	Trichlorethylene	100	-
Diesel	100	+	Lutensit TC KLC 50	3	+
Petrol	100	+	Marlophen NP 9,5	2	+
Methanol	100	-	Water	95	+
Dichloromethane	100	-	Tetrahydrofurane	100	-
Mono-chlorobenzene	100	o	Deminerlized water	100	+
Ethylacetat	50	-	Salt water	saturated	+
Methylisobutylketone	50	-	Salt spray testing	-	+
Salicylic acid-	50	+	SO ₂	-	+
Acetophenon	50	+	Enviroment/wheather	-	+
Acetic acid	50	-	Oil for formwork (forming oil)	100	+
Propionic acid	50	-	Concentrate plasticizer	-	+
Sulfuric acid	100	-	Concrete potash solution	-	+
Nitric acid	100	-	Concrete potash solution	-	+
Hydrochloric acid	36	-	Saturated suspension of borehole cuttings	-	+
Potassium hydroxide	100	-			

- + Resistant
- Not resistant
- o Partially Resistant

Electrical Conductivity

HIT-RE 500 V3 in the hardened state **is not conductive electrically**. Its electric resistivity is $66 \cdot 10^{12} \Omega \cdot m$ (DIN IEC 93 – 12.93). It is adapted well to realize electrically insulating anchorings (ex: railway applications, subway).

Installation temperature range

-5°C to +40°C

Service temperature range

Hilti HIT-RE 500 V3 injection mortar may be applied in the temperature ranges given below. An elevated base material temperature may lead to a reduction of the design bond resistance.

Temperature range	Base material temperature	Maximum long term base material temperature	Maximum short term base material temperature
Temperature range I	-40 °C to +80 °C	+50 °C	+80 °C

Max short term base material temperature

Short-term elevated base material temperatures are those that occur over brief intervals, e.g. as result of diurnal cycling.

Max long term base material temperature

Long-term elevated base material temperatures are roughly constant over significant periods of time.

Working time and curing time ¹⁾

Temperature of the base material	Working time in which rebar can be inserted and adjusted t_{gel}	Initial curing time $t_{cure,ini}$	Curing time before rebar can be fully loaded t_{cure}
$5\text{ °C} \leq T_{BM} < -1\text{ °C}$	2 h	48 h	168 h
$0\text{ °C} \leq T_{BM} < 4\text{ °C}$	2 h	24 h	48 h
$5\text{ °C} \leq T_{BM} < 9\text{ °C}$	2 h	16 h	24 h
$10\text{ °C} \leq T_{BM} < 14\text{ °C}$	1,5 h	12 h	16 h
$15\text{ °C} \leq T_{BM} < 19\text{ °C}$	1 h	8 h	16 h
$20\text{ °C} \leq T_{BM} < 24\text{ °C}$	30 min	4 h	7 h
$25\text{ °C} \leq T_{BM} < 29\text{ °C}$	20 min	3,5 h	6 h
$30\text{ °C} \leq T_{BM} < 34\text{ °C}$	15 min	3 h	5 h
$35\text{ °C} \leq T_{BM} < 39\text{ °C}$	12 min	2 h	4,5 h
$T_{BM} = 40\text{ °C}$	10 min	2 h	4 h

1) The curing time data are valid for dry base material only. In wet base material the curing times must be doubled.

Setting information

Installation equipment

Rebar – size	$\phi 8$	$\phi 10$	$\phi 12$	$\phi 14$	$\phi 16$	$\phi 18$	$\phi 20$	$\phi 25$	$\phi 28$	$\phi 32$	$\phi 34$	$\phi 36$	$\phi 40$
Rotary hammer	TE 2 (-A)– TE 40(-A)						TE40 – TE80						
Other tools	Blow out pump ($h_{ef} \leq 10 \cdot d$)						Compressed air gun ^{a)} Set of cleaning brushes ^{b)} , dispenser, piston plug Roughening tools						

a) Compressed air gun with extension hose for all drill holes deeper than 250 mm (for $\phi 8$ to $\phi 12$) or deeper than $20 \cdot \phi$ (for $\phi > 12$ mm)

b) Automatic brushing with round brush for all drill holes deeper than 250 mm (for $\phi 8$ to $\phi 12$) or deeper than $20 \cdot \phi$ (for $\phi > 12$ mm).

Minimum concrete cover c_{min} of the post-installed rebar

Drilling method	Bar diameter [mm]	Minimum concrete cover c_{min} [mm]	
		Without drilling aid	With drilling aid
Hammer drilling (HD) and (HDB)	$\phi < 25$	$30 + 0,06 \cdot l_v \geq 2 \cdot \phi$	$30 + 0,02 \cdot l_v \geq 2 \cdot \phi$
	$\phi \geq 25$	$40 + 0,06 \cdot l_v \geq 2 \cdot \phi$	$40 + 0,02 \cdot l_v \geq 2 \cdot \phi$
Compressed air drilling (CA)	$\phi < 25$	$50 + 0,08 \cdot l_v$	$50 + 0,02 \cdot l_v$
	$\phi \geq 25$	$60 + 0,08 \cdot l_v \geq 2 \cdot \phi$	$60 + 0,02 \cdot l_v \geq 2 \cdot \phi$
Diamond coring in wet (PCC) dry (DD)	$\phi < 25$	Drill stand works like a drilling aid	$30 + 0,02 \cdot l_v \geq 2 \cdot \phi$
	$\phi \geq 25$		$40 + 0,02 \cdot l_v \geq 2 \cdot \phi$
Diamond coring with Roughening too	$\phi < 25$	$30 + 0,06 \cdot l_v \geq 2 \cdot \phi$	$30 + 0,02 \cdot l_v \geq 2 \cdot \phi$
	$\phi \geq 25$	$40 + 0,06 \cdot l_v \geq 2 \cdot \phi$	$40 + 0,02 \cdot l_v \geq 2 \cdot \phi$

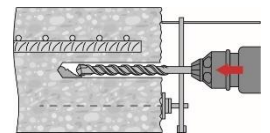

Dispenser and corresponding maximum embedment depth $l_{v,max}$

Rebar – size [mm]	HDM 330, HDM 500	HDE 500
	$l_{v,max}$ [mm]	
φ8	1000	1000
φ10	1000	1000
φ12	1000	1200
φ14	1000	1400
φ16	1000	1600
φ18	700	1800
φ20	600	2000
φ22	500	1800
φ24	300	1300
φ25	300	1500
φ26	300	1000
φ28	300	1000
φ30	-	1000
φ32		700
φ34		600
φ36		600
φ40		400

Drilling diameters

Rebar - size	Hammer drill (HD)	Hollow Drill Bit (HDB) ^{b)}	Compressed air drill (CA)	Diamond coring		
				Dry (PCC) ^{b)}	Wet (DD)	With roughening tool (RT) ^{b)}
d_0 [mm]						
φ8	12 (10 ^{a)})	-	-	-	12 (10 ^{a)})	-
φ10	14 (12 ^{a)})	14 (12 ^{a)})	-	-	14 (12 ^{a)})	-
φ12	16 (14 ^{a)})	16 (14 ^{a)})	17	-	16 (14 ^{a)})	-
φ14	18	18	17	-	18	18
φ16	20	20	20	-	20	20
φ18	22	22	22	-	22	22
φ20	25	25	26	-	25	25
φ22	28	28	28	-	28	28
φ24	32 (30 ^{a)})	32 (30 ^{a)})	32	-	32	32
φ25	32 (30 ^{a)})	32 (30 ^{a)})	32	-	32	32
φ26	35	35	35	35	35	35
φ28	35	35	35	35	35	35
φ30	37	-	37	35	37	-
φ32	40	-	40	47	40	-
φ34	45	-	42	47	45	-
φ36	45	-	45	47	47	-
φ40	55	-	57	52	52	-

c) Each of two given values can be used.

d) No cleaning required

Associated components for the use of Hilti Roughening tool TE-YRT

Diamond coring		Roughening tool TE-YRT	Wear gauge RTG...
d ₀ [mm]		d ₀ [mm]	size
Nominal	measured		
18	17,9 to 18,2	18	18
20	19,9 to 20,2	20	20
22	21,9 to 22,2	22	22
25	24,9 to 25,2	25	25
28	27,9 to 28,2	28	28
30	29,9 to 30,2	30	30
32	31,9 to 32,2	32	32
35	34,9 to 35,2	35	35

Minimum roughening time t_{roughen} (t_{roughen} [sec] = h_{ef} [mm] / 10)

h _{ef} [mm]	t _{roughen} [sec]
0 to 100	10
101 to 200	20
201 to 300	30
301 to 400	40
401 to 500	50
501 to 600	60

Setting instructions

*For detailed information on installation see instruction for use given with the package of the product.



Safety regulations.

Review the Material Safety Data Sheet (MSDS) before use for proper and safe handling! Wear well-fitting protective goggles and protective gloves when working with Hilti HIT-RE 500 V3.

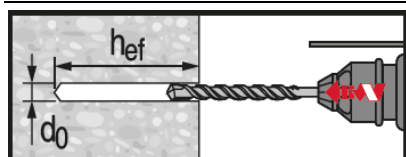

Hammer drilled hole (HD)

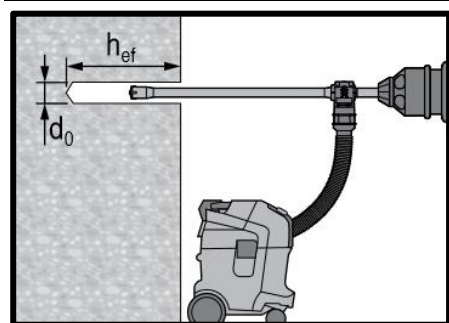

Hammer drilled hole with Hollow Drilled Bit (HDB)

No cleaning required

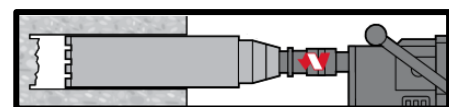

Diamond Drilling (DD)

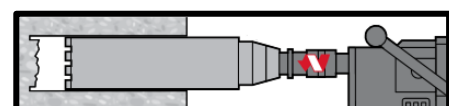

Diamond Drilling + Roughening Tool (DD+RT)

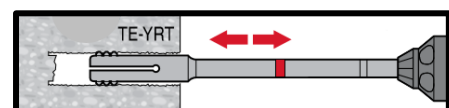

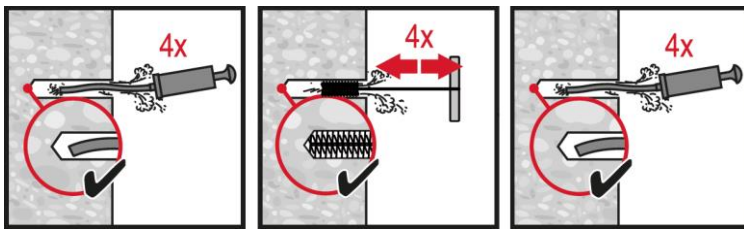

Hammer Drilling:

Manual cleaning (MC)

for drill diameters $d_0 \leq 20$ mm and drill hole depth $h_0 \leq 10 \cdot d$.

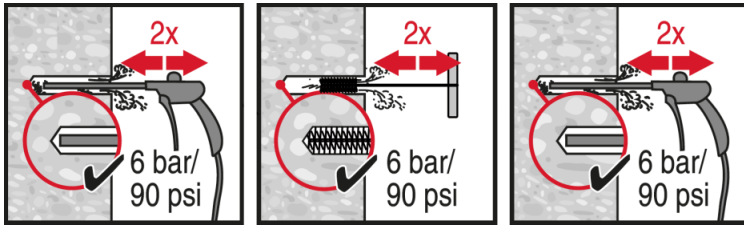

Hammer Drilling:

Compressed air cleaning (CAC)

for all drill hole diameters d_0 and drill hole depths $h_0 \leq 20 \cdot d$.

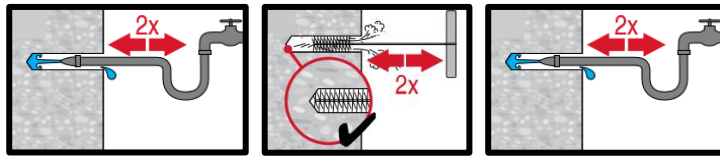

Diamond cored holes:

Compressed air cleaning (CAC)

for all drill hole diameters d_0 and drill hole depths h_0 .

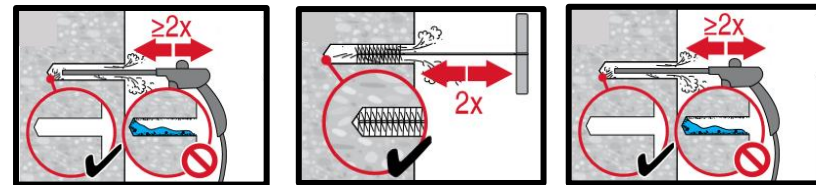

Diamond cored holes with Hilti roughening tool:

Compressed air cleaning (CAC)

for all drill hole diameters d_0 and drill hole depths h_0 .

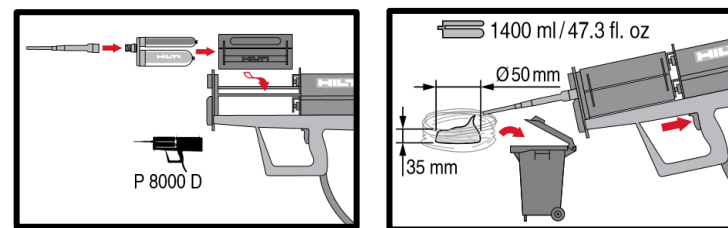
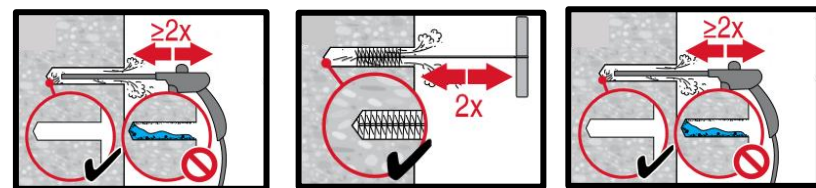

Injection system preparation.

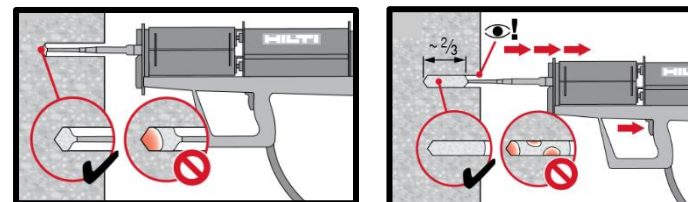

Injection method for drill hole depth

$h_{ef} \leq 250$ mm.

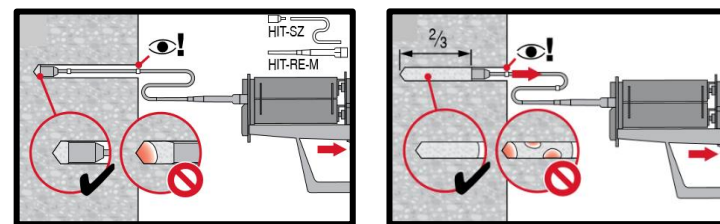

Injection method for drill hole depth

$h_{ef} > 250$ mm.

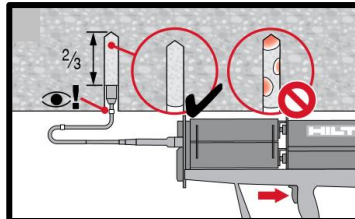
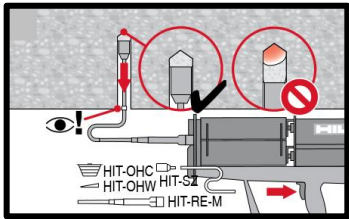

Injection method for overhead application.

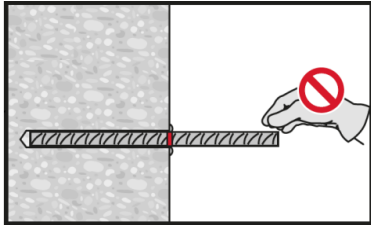
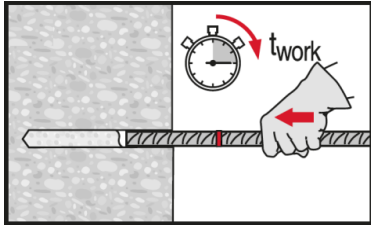

Setting element, observe working time "t_{work}".

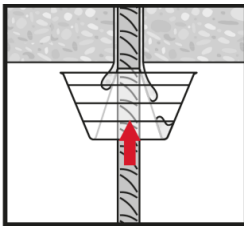
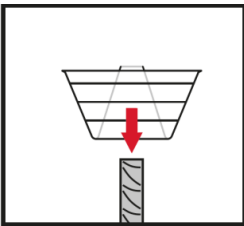
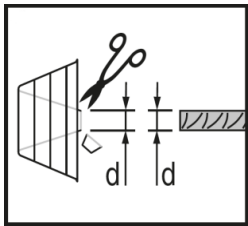

Setting element for overhead applications, observe working time "t_{work}".

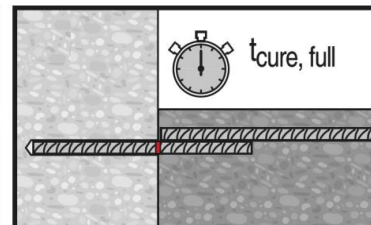
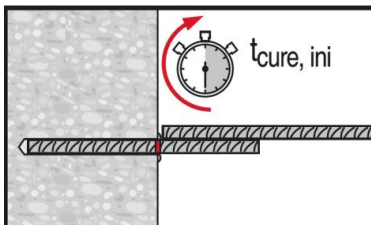
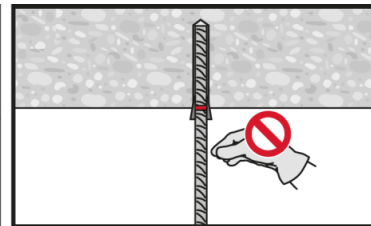
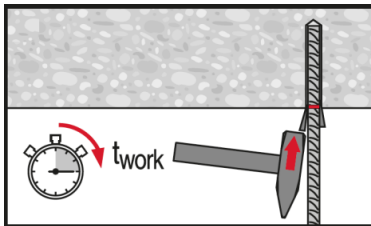

Apply full load only after curing time "t_{cure}".

HIT-HY 200 injection mortar

Anchor design (ETAG 001) / Rods&Sleeves / Concrete

Concrete

Chemical anchors

Mechanical anchors

Plastic/Light duty metal anchors

Insulation anchors

Injection mortar system



Hilti HIT- HY 200-A
500 ml foil pack
(also available as 330 ml foil pack)

Hilti HIT- HY 200-R
500 ml foil pack
(also available as 330 ml foil pack)

Anchor rod:
HIT-V
HIT-V-F
HIT-V-R
HIT-V-HCR
(M8-M30)

Internally threaded sleeve:
HIS-N
HIS-RN
(M8-M20)

Anchor rod:
HIT-Z
HIT-Z-F
HIT-Z-R
(M8-M20)

Benefits

- **SafeSet** technology: drilling and borehole cleaning in one step with Hilti hollow drill bit
- Suitable for non-cracked and cracked concrete C 20/25 to C 50/60
- ETA Approved for seismic performance category C1, C2^{a)}
- Maximum load performance in cracked concrete and non-cracked concrete
- High corrosion / corrosion resistance^{b)}
- Small edge distance and anchor spacing possible
- Manual cleaning for borehole diameter up to 20mm and $h_{ef} \leq 10d$ for non-cracked concrete only
- Two mortar versions: HY 200-R for slow cure applications and HY 200-A for fast cure applications

a) HIS-N internally threaded sleeves not approved for Seismic.
b) High Corrosion resistant rods available only for HIT-V. Corrosion resistant rods available for HIT-V and HIS-N

Base material

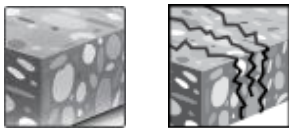

Concrete (non-cracked) Concrete (cracked)

Installation conditions



Hammer drilled holes Diamond drilled holes ^{c)} Hilti **SafeSet** technology Variable embedment depth Small edge distance and spacing

Load conditions



Static/quasi-static Seismic, ETA-C1, C2^{a)} Fire resistance

Other information



European Technical Assessment CE conformity Corrosion resistance^{b)} A4 316 High corrosion resistance^{b)} HCR highMo PROFIS Anchor design Software

a) HIS-N internally threaded sleeves not approved for Seismic category C2.
b) High Corrosion resistant rods available only for HIT-V. Corrosion resistant rods available for HIT-V and HIS-N
c) Diamond drilling only covered for HIT-Z rods

Approvals / certificates

Description	Authority / Laboratory	No. / date of issue
European technical Assessment ^{a)}	DIBt, Berlin	ETA-11/0493/ 2017-07-28 (HY200 A)
European technical Assessment ^{a)}	DIBt, Berlin	ETA-12/0006/ 2017-05-30 (HY200 A)
European technical Assessment ^{a)}	DIBt, Berlin	ETA-11/0492/ 2014-06-26 (HY200 A)
European technical Assessment ^{a)}	DIBt, Berlin	ETA-12/0084/ 2017-07-28 (HY200 R)
European technical Assessment ^{a)}	DIBt, Berlin	ETA-12/0028/ 2017-05-30 (HY200 R)
European technical Assessment ^{a)}	DIBt, Berlin	ETA-12/0083/ 2018-06-26 (HY200 R)
Shockproof fastenings in civil defence installations	Federal Office for Civil Protection, Bern	BZS D 13-604 / 2013-12-31 BZS D 13-603 / 2013-12-31
Fire test report	IBMB, Brunswick	3502/676/12 / 2017-09-15

a) All data given in this section according to the ETA approval for the product.

Static and quasi-static resistance (for a single anchor)

All data in this section applies to:

- Correct setting (See setting instruction)
- No edge distance and spacing influence
- Steel failure
- Minimum base material thickness
- One typical embedment depth, as specified in the table
- One anchor material, as specified in the tables
- Concrete C 20/25, $f_{ck,cube} = 25 \text{ N/mm}^2$
- Temperature range I (min. base material temp. -40°C , max. long/short term base material temp.: $+24^\circ\text{C}/40^\circ\text{C}$)

For hammer drilled holes, hammer drilled holes with Hilti hollow drill bit:

Anchorage depth ¹⁾

Anchor size		M8	M10	M12	M16	M20	M24	M27	M30
HIT-V									
Embedment depth	[mm]	80	90	110	125	170	210	240	270
Base material thickness	[mm]	110	120	140	161	234	266	300	340
HIS-N									
Embedment depth	[mm]	90	110	125	170	205	-	-	-
Base material thickness	[mm]	120	150	170	230	270	-	-	-
HIT-Z									
Effective anchorage depth ²⁾	$h_{ef}=l_{Helix}$ [mm]	50	60	60	96	100	-	-	-
Effective embedment depth ³⁾	$h_{ef}=h_{nom,min}$ [mm]	70	90	110	145	180	-	-	-
Base material thickness	[mm]	130	150	170	245	280	-	-	-

1) The allowed range of embedment depth is shown in the setting details.

2) For combined pull-out and concrete cone failure

3) For concrete cone failure

a) Hilti anchor rod HIT-Z-F: M16 and M20

Characteristic resistance

Anchor size		M8	M10	M12	M16	M20	M24	M27	M30
Non-cracked concrete									
Tension N_{Rk}	HIT-V 5.8	18,0	29,0	42,0	70,6	111,9	153,7	187,8	224,0
	HIS-N 8.8	25,0	46,0	67,0	111,9	116,0	-	-	-
	HIT-Z ^{a)}	24,0	38,0	54,3	88,2	122,0	-	-	-
Shear V_{Rk}	HIT-V 5.8	9,0	15,0	21,0	39,0	61,0	88,0	115,0	140,0
	HIS-N 8.8	13,0	23,0	34,0	63,0	58,0	-	-	-
	HIT-Z ^{a)}	12,0	19,0	27,0	48,0	73,0	-	-	-
Cracked concrete									
Tension N_{Rk}	HIT-V 5.8	15,1	21,2	35,2	50,3	79,8	109,6	133,9	159,7
	HIS-N 8.8	24,7	39,9	50,3	79,8	105,7	-	-	-
	HIT-Z ^{a)}	21,1	30,7	41,5	62,9	86,9	-	-	-
Shear V_{Rk}	HIT-V 5.8	9,0	15,0	21,0	39,0	61,0	88,0	115,0	140,0
	HIS-N 8.8	13,0	23,0	34,0	63,0	58,0	-	-	-
	HIT-Z ^{a)}	12,0	19,0	27,0	48,0	73,0	-	-	-

a) Hilti anchor rod HIT-Z-F: M16 and M20

Design resistance

Anchor size		M8	M10	M12	M16	M20	M24	M27	M30
Non-cracked concrete									
Tension N_{Rd}	HIT-V 5.8	12,0	19,3	28,0	47,1	74,6	102,5	125,2	149,4
	HIS-N 8.8	16,7	30,7	44,7	74,6	77,3	-	-	-
	HIT-Z ^{a)}	16,0	25,3	36,2	58,8	81,3	-	-	-
Shear V_{Rd}	HIT-V 5.8	7,2	12,0	16,8	31,2	48,8	70,4	92,0	112,0
	HIS-N 8.8	10,4	18,4	27,2	50,4	46,4	-	-	-
	HIT-Z ^{a)}	9,6	15,2	21,6	38,4	58,4	-	-	-
Cracked concrete									
Tension N_{Rd}	HIT-V 5.8	10,1	14,1	23,5	33,5	53,2	73,0	89,2	106,5
	HIS-N 8.8	16,5	26,6	33,5	53,2	70,4	-	-	-
	HIT-Z ^{a)}	14,1	20,5	27,7	41,9	58,0	-	-	-
Shear V_{Rd}	HIT-V 5.8	7,2	12,0	16,8	31,2	48,8	70,4	92,0	112,0
	HIS-N 8.8	10,4	18,4	27,2	50,4	46,4	-	-	-
	HIT-Z ^{a)}	9,6	15,2	21,6	38,4	58,4	-	-	-

a) Hilti anchor rod HIT-Z-F: M16 and M20

Recommended loads^{b)}

Anchor size		M8	M10	M12	M16	M20	M24	M27	M30
Non-cracked concrete									
Tension N_{Rec}	HIT-V 5.8	8,6	13,8	20,0	33,6	53,3	73,2	89,4	106,7
	HIS-N 8.8	11,9	21,9	31,9	53,3	55,2	-	-	-
	HIT-Z ^{a)}	11,4	18,1	25,9	42,0	58,1	-	-	-
Shear V_{Rec}	HIT-V 5.8	5,1	8,6	12,0	22,3	34,9	50,3	65,7	80,0
	HIS-N 8.8	7,4	13,1	19,4	36,0	33,1	-	-	-
	HIT-Z ^{a)}	6,9	10,9	15,4	27,4	41,7	-	-	-
Cracked concrete									
Tension N_{Rec}	HIT-V 5.8	7,2	10,1	16,8	24,0	38,0	52,2	63,7	76,1
	HIS-N 8.8	11,9	19,8	23,9	38,0	50,3	-	-	-
	HIT-Z ^{a)}	10,0	14,6	19,8	29,9	41,4	-	-	-
Shear V_{Rec}	HIT-V 5.8	5,1	8,6	12,0	22,3	34,9	50,3	65,7	80,0
	HIS-N 8.8	7,4	13,1	19,4	36,0	33,1	-	-	-
	HIT-Z ^{a)}	6,9	10,9	15,4	27,4	41,7	-	-	-

a) Hilti anchor rod HIT-Z-F: M16 and M20

b) With overall partial safety factor for action $\gamma = 1,4$. The partial safety factors for action depend on the type of loading and shall be taken from national regulations.

Seismic resistance (for a single anchor)

All data in this section applies to:

- Correct setting (See setting instruction with hammer drilling)
- No edge distance and spacing influence
- **Steel** failure
- Minimum base material thickness
- Concrete C 20/25, $f_{ck,cube} = 25 \text{ N/mm}^2$
- Temperature range I (min. base material temp. -40°C , max. long/short term base material temp.: $+24^\circ\text{C}/40^\circ\text{C}$)
- Installation temperature range -10°C to $+40^\circ\text{C}$
- $\alpha_{gap} = 1,0$ (using Hilti seismic filling set)

For hammer drilled holes and hammer drilled holes with Hilti hollow drill bit:

Anchorage depth for seismic C2

Anchor size		M8	M10	M12	M16	M20	M24	M27	M30
HIT-V									
Embedment depth	h_{ef} [mm]	-	-	-	125	170	210	-	-
HIT-Z									
Effective anchorage depth ²⁾	$h_{ef} = l_{Helix}$ [mm]	-	-	60	96	100	-	-	-
Effective embedment depth ³⁾	h_{ef} [mm]	-	-	60	96	100	-	-	-
Base material thickness	[mm]	-	-	170	245	280	-	-	-

2) For combined pull-out and concrete cone failure

3) For concrete cone failure

Characteristic resistance in case of seismic performance category C2

Anchor size		M8	M10	M12	M16	M20	M24	M27	M30
Tension $N_{Rk,seis}$	HIT-V 8.8, AM 8.8	-	-	-	24,5	45,9	55,4	-	-
	HIT-Z ^{a)}	-	-	29,4	53,4	73,9	-	-	-
Shear $V_{Rk,seis}$	HIT-V 8.8, AM 8.8	-	-	-	46,0	77,0	103,0	-	-
	HIT-Z ^{a)}	-	-	23,0	41,0	61,0	-	-	-

a) Hilti anchor rod HIT-Z-F: M16 and M20

Design resistance in case of seismic performance category C2

Anchor size		M8	M10	M12	M16	M20	M24	M27	M30
Tension $N_{Rd,seis}$	HIT-V 8.8, AM 8.8	-	-	-	16,3	30,6	36,9	-	-
	HIT-Z ^{a)}	-	-	19,6	35,6	49,3	-	-	-
Shear $V_{Rd,seis}$	HIT-V 8.8, AM 8.8	-	-	-	36,8	61,6	82,4	-	-
	HIT-Z ^{a)}	-	-	18,4	32,8	48,8	-	-	-

a) Hilti anchor rod HIT-Z-F: M16 and M20

Anchorage depth for seismic C1

Anchor size		M8	M10	M12	M16	M20	M24	M27	M30
HIT-V									
Embedment depth	h_{ef} [mm]	-	90	110	125	170	210	240	270
HIT-Z									
Effective anchorage depth ¹⁾	$h_{ef} = l_{Helix}$ [mm]	50	60	60	96	100	-	-	-
Effective embedment depth ²⁾	h_{ef} [mm]	60	60	60	96	100	-	-	-
Base material thickness	[mm]	-	-	170	245	280	-	-	-

1) For combined pull-out and concrete cone failure

2) For concrete cone failure

Characteristic resistance in case of seismic performance category C1

Anchor size		M8	M10	M12	M16	M20	M24	M27	M30
Tension $N_{Rk,seis}$	HIT-V 8.8, AM 8.8	-	14,7	29,0	42,8	67,8	93,1	113,8	135,8
	HIT-Z ^{a)} ; HIT-Z-R	17,9	26,1	35,3	53,4	73,9	-	-	-
Shear $V_{Rk,seis}$	HIT-V 8.8, AM 8.8	-	23,0	34,0	63,0	98,0	141,0	184,0	224,0
	HIT-Z ^{a)}	7,0	17,0	16,0	28,0	45,0	-	-	-
	HIT-Z-R	8,0	19,0	22,0	31,0	48,0	-	-	-

a) Hilti anchor rod HIT-Z-F: M16 and M20

Design resistance in case of seismic performance category C1

Anchor size		M8	M10	M12	M16	M20	M24	M27	M30
Tension $N_{Rd,seis}$	HIT-V 8.8, AM 8.8	-	9,8	19,4	28,5	45,2	62,1	75,8	90,5
	HIT-Z ^{a)} ; HIT-Z-R	11,9	17,4	23,5	35,6	49,3	-	-	-
Shear $V_{Rd,seis}$	HIT-V 8.8, AM 8.8	-	18,4	27,2	50,4	78,4	112,8	147,2	179,2
	HIT-Z ^{a)}	5,6	13,6	12,8	22,4	36,0	-	-	-
	HIT-Z-R	6,4	15,2	17,6	24,8	38,4	-	-	-

a) Hilti anchor rod HIT-Z-F: M16 and M20

Materials

Materials properties for HIT-V

Anchor size		M8	M10	M12	M16	M20	M24	M27	M30
Nominal tensile strength f_{uk}	HIT-V 5.8 (F)	500	500	500	500	500	500	500	500
	HIT-V 8.8 (F) AM 8.8 (HDG)	800	800	800	800	800	800	800	800
	HIT-V-R	700	700	700	700	700	700	500	500
	HIT-V-HCR	800	800	800	800	800	700	700	700
Yield strength f_{yk}	HIT-V 5.8 (F)	400	400	400	400	400	400	400	400
	HIT-V 8.8 (F) AM 8.8 (HDG)	640	640	640	640	640	640	640	640
	HIT-V-R	450	450	450	450	450	450	210	210
	HIT-V-HCR	640	640	640	640	640	400	400	400
Stressed cross-section A_s	HIT-V	36,6	58,0	84,3	157	245	353	459	561
Moment of resistance W	HIT-V	31,2	62,3	109	277	541	935	1387	1874

Mechanical properties for HIS-N

Anchor size		M8	M10	M12	M16	M20
Nominal tensile strength f_{uk}	HIS-N	490	490	460	460	460
	Screw 8.8	800	800	800	800	800
	HIS-RN	700	700	700	700	700
	Screw A4-70	700	700	700	700	700
Yield strength f_{yk}	HIS-N	410	410	375	375	375
	Screw 8.8	640	640	640	640	640
	HIS-RN	350	350	350	350	350
	Screw A4-70	450	450	450	450	450
Stressed cross-section A_s	HIS-(R)N	51,5	108,0	169,1	256,1	237,6
	Screw	36,6	58	84,3	157	245
Moment of resistance W	HIS-(R)N	145	430	840	1595	1543
	Screw	31,2	62,3	109	277	541

Mechanical properties for HIT-Z

Anchor size		M8	M10	M12	M16	M20
Nominal tensile strength f_{uk}	HIT-Z(-F) ^{a)} [N/mm ²]	650	650	650	610	595
	HIT-Z-R	650	650	650	610	595
Yield strength f_{yk}	HIT-Z(-F) ^{a)} [N/mm ²]	520	520	520	490	480
	HIT-Z-R	520	520	520	490	480
Stressed cross-section of thread A_s	HIT-Z(-F) ^{a)} [mm ²] HIT-Z-R	36,6	58,0	84,3	157	245
Moment of resistance W	HIT-Z(-F) ^{a)} [mm ³] HIT-Z-R	31,9	62,5	109,7	278	542

a) Hilti anchor rod HIT-Z-F: M16 and M20

Material quality for HIT-V

Part	Material
Zinc coated steel	
Threaded rod, HIT-V 5.8 (F)	Strength class 5.8; Elongation at fracture A5 > 8% ductile Electroplated zinc coated $\geq 5\mu\text{m}$; (F) hot dip galvanized $\geq 45\mu\text{m}$
Threaded rod, HIT-V 8.8 (F)	Strength class 8.8; Elongation at fracture A5 > 12% ductile Electroplated zinc coated $\geq 5\mu\text{m}$; (F) hot dip galvanized $\geq 45\mu\text{m}$
Hilti Meter rod, AM 8.8 (HDG)	Strength class 8.8; Elongation at fracture A5 > 12% ductile Electroplated zinc coated $\geq 5\mu\text{m}$ (HDG) hot dip galvanized $\geq 45\mu\text{m}$
Washer	Electroplated zinc coated $\geq 5\mu\text{m}$, hot dip galvanized $\geq 45\mu\text{m}$
Nut	Strength class of nut adapted to strength class of threaded rod. Electroplated zinc coated $\geq 5\mu\text{m}$, hot dip galvanized $\geq 45\mu\text{m}$
Hilti Filling set (F)	Filling washer: Electroplated zinc coated $\geq 5\mu\text{m}$ / (F) Hot dip galvanized $\geq 45\mu\text{m}$
	Spherical washer: Electroplated zinc coated $\geq 5\mu\text{m}$ / (F) Hot dip galvanized $\geq 45\mu\text{m}$
	Lock nut: Electroplated zinc coated $\geq 5\mu\text{m}$ / (F) Hot dip galvanized $\geq 45\mu\text{m}$
Stainless Steel	
Threaded rod, HIT-V-R	Strength class 70 for $\leq M24$ and strength class 50 for $> M24$; Elongation at fracture A5 > 8% ductile Stainless steel 1.4401; 1.4404; 1.4578; 1.4571; 1.4439; 1.4362
Washer	Stainless steel 1.4401, 1.4404, 1.4578, 1.4571, 1.4439, 1.4362 EN 10088-1:2014
Nut	Stainless steel 1.4401, 1.4404, 1.4578, 1.4571, 1.4439, 1.4362 EN 10088-1:2014
High corrosion resistant steel	
Threaded rod, HIT-V-HCR	Strength class 80 for $\leq M20$ and class 70 for $> M20$, Elongation at fracture A5 > 8% ductile High corrosion resistance steel 1.4529; 1.4565;
Washer	High corrosion resistant steel 1.4529, 1.4565 EN 10088-1:2014
Nut	High corrosion resistant steel 1.4529, 1.4565 EN 10088-1:2014

Material quality for HIS-N

Part	Material	
HIS-N	Int. threaded sleeve	Electroplated zinc coated $\geq 5\mu\text{m}$
	Screw 8.8	Strength class 8.8, A5 > 8 % Ductile; Steel galvanized $\geq 5\mu\text{m}$
HIS-RN	Int. threaded sleeve	Stainless steel 1.4401, 1.4571
	Screw 70	Strength class 70, A5 > 8 % Ductile; Stainless steel 1.4401; 1.4404, 1.4578; 1.4571; 1.4439; 1.4362

Material quality for HIT-Z

Part	Material
Threaded rod HIT-Z	Elongation at fracture > 8% ductile; Electroplated zinc coated $\geq 5 \mu\text{m}$
Washer	Electroplated zinc coated $\geq 5 \mu\text{m}$
Nut	Strength class of nut adapted to strength class of anchor rod. Electroplated zinc coated $\geq 5 \mu\text{m}$
HIT-Z-F	Elongation at fracture > 8% ductile Multilayer coating, ZnNi-galvanized according to DIN 50979:2008-07
Washer	Multilayer coating, ZnNi-galvanized according to DIN 50979:2008-07
Nut	Multilayer coating, ZnNi-galvanized according to DIN 50979:2008-07
HIT-Z-R	Elongation at fracture > 8% ductile; Stainless steel 1.4401, 1.4404 EN 10088-1:2014
Washer	Stainless steel A4 according to EN 10088-1:2014
Nut	Strength class of nut adapted to strength class of anchor rod. Stainless steel 1.4401, 1.4404 EN 10088-1:2014

Setting information

In service temperature range

Hilti HIT-HY 200 A (R) injection mortar with anchor rod HIT-V / HIS-(R)N may be applied in the temperature ranges given below. An elevated base material temperature leads to a reduction of the design bond resistance.

Temperature in the base material

Temperature range	Base material temperature	Maximum long term base material temperature	Maximum short term base material temperature
Temperature range I	-40 °C to +40 °C	+24 °C	+40 °C
Temperature range II	-40 °C to +80 °C	+50 °C	+80 °C
Temperature range III	-40 °C to +120 °C	+72 °C	+120 °C

Max short term base material temperature

Short-term elevated base material temperatures are those that occur over brief intervals, e.g. as a result of diurnal cycling.

Max long term base material temperature

Long-term elevated base material temperatures are roughly constant over significant periods of time.

Curing and working time

Temperature of the base material	HIT-HY 200-A		HIT-HY 200-R	
	Maximum working time t_{work}	Minimum curing time t_{cure}	Maximum working time t_{work}	Minimum curing time t_{cure}
$-10^{\circ}\text{C} < T_{\text{BM}} \leq -5^{\circ}\text{C}$	1,5 h	7 h	3 h	20 h
$-5^{\circ}\text{C} < T_{\text{BM}} \leq 0^{\circ}\text{C}$	50 min	4 h	2 h	8 h
$0^{\circ}\text{C} < T_{\text{BM}} \leq 5^{\circ}\text{C}$	25 min	2 hour	1 h	4 h
$5^{\circ}\text{C} < T_{\text{BM}} \leq 10^{\circ}\text{C}$	15 min	75 min	40 min	2,5 h
$10^{\circ}\text{C} < T_{\text{BM}} \leq 20^{\circ}\text{C}$	7 min	45 min	15 min	1,5 h
$20^{\circ}\text{C} < T_{\text{BM}} \leq 30^{\circ}\text{C}$	4 min	30 min	9 min	1 h
$30^{\circ}\text{C} < T_{\text{BM}} \leq 40^{\circ}\text{C}$	3 min	30 min	6 min	1 h

Setting details for HIT-V

Anchor size		M8	M10	M12	M16	M20	M24	M27	M30
Nominal diameter of drill bit d	[mm]	10	12	14	18	22	28	30	35
Eff. embedment depth and drill hole depth ^{a)}	$h_{ef,min}$ [mm]	60	60	70	80	90	96	108	120
	$h_{ef,max}$ [mm]	160	200	240	320	400	480	540	600
Minimum base material thickness	h_{min} [mm]	$h_{ef} + 30 \text{ mm} \geq 100 \text{ mm}$			$h_{ef} + 2 d_0$				
Maximum diameter of clearance hole in the fixture	d_f [mm]	9	12	14	18	22	26	30	33
Thickness of Hilti filling set	h_{fs} [mm]	-	-	-	11	13	15	-	-
Effective fixture thickness with Hilti filling set	$t_{fix,eff}$ [mm]	$t_{fix,eff} - h_{fs}$							
Max. torque moment ^{b)}	T_{max} [Nm]	10	20	40	80	150	200	270	300
Minimum spacing	s_{min} [mm]	40	50	60	75	90	115	120	140
Minimum edge distance	c_{min} [mm]	40	45	45	50	55	60	75	80
Critical spacing for splitting failure	$s_{cr,sp}$ [mm]	$2 C_{cr,sp}$							
Critical edge distance for splitting failure ^{c)}	$c_{cr,sp}$ [mm]	$1,0 \cdot h_{ef}$ for $h / h_{ef} \geq 2,00$							
		$4,6 h_{ef} - 1,8 h$ for $2,00 > h / h_{ef} > 1,3$							
		$2,26 h_{ef}$ for $h / h_{ef} \leq 1,3$							
Critical spacing for concrete cone failure	$s_{cr,N}$ [mm]	$2 C_{cr,sp}$							
Critical edge distance for concrete cone failure ^{d)}	$c_{cr,N}$ [mm]	$1,5 h_{ef}$							

For spacing (edge distance) smaller than critical spacing (critical edge distance) the design loads have to be reduced.

- a) $h_{ef,min} \leq h_{ef} \leq h_{ef,max}$ (h_{ef} : embedment depth)
- b) Maximum recommended torque moment to avoid splitting failure during installation with minimum spacing and edge distance
- c) h : base material thickness ($h \geq h_{min}$)
- d) The critical edge distance for concrete cone failure depends on the embedment depth h_{ef} and the design bond resistance. The simplified formula given in this table is on the save side.

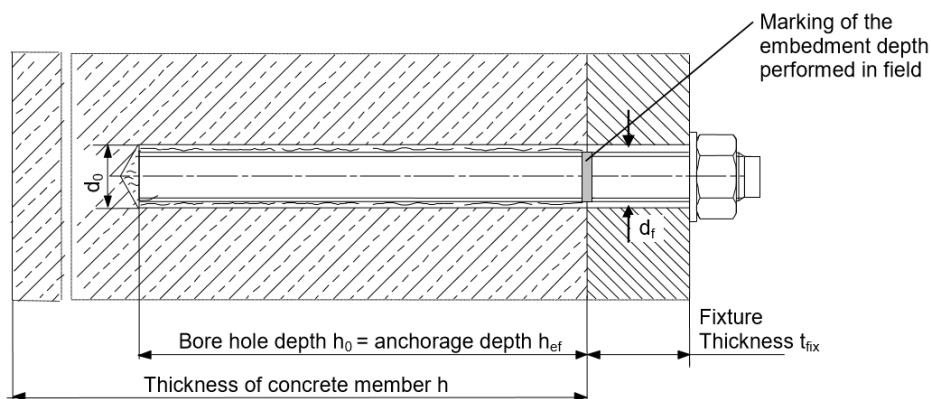
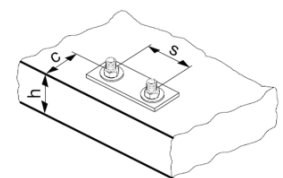

Setting details for HIS-N

Anchor size		M8	M10	M12	M16	M20
Nominal diameter of drill bit d_0	[mm]	14	18	22	28	32
Diameter of element d	[mm]	12,5	16,5	20,5	25,4	27,6
Effective anchorage and drill hole depth h_{ef}	[mm]	90	110	125	170	205
Minimum base material thickness h_{min}	[mm]	120	150	170	230	270
Diameter of clearance hole in the fixture d_f	[mm]	9	12	14	18	22
Thread engagement length; min - max h_s	[mm]	8-20	10-25	12-30	16-40	20-50
Minimum spacing s_{min}	[mm]	60	75	90	115	130
Minimum edge distance c_{min}	[mm]	40	45	55	65	90
Critical spacing for splitting failure $s_{cr,sp}$	[mm]	$2 C_{cr,sp}$				
Critical edge distance for splitting failure ^{b)} $c_{cr,sp}$	[mm]	$1,0 \cdot h_{ef}$ for $h / h_{ef} \geq 2,0$				
		$4,6 h_{ef} - 1,8 h$ for $2,0 > h / h_{ef} > 1,3$				
		$2,26 h_{ef}$ for $h / h_{ef} \leq 1,3$				
Critical spacing for concrete cone failure $s_{cr,N}$	[mm]	$2 C_{cr,N}$				
Critical edge distance for concrete cone failure ^{c)} $c_{cr,N}$	[mm]	$1,5 h_{ef}$				
Max. torque moment ^{a)} T_{max}	[Nm]	10	20	40	80	150

For spacing (edge distance) smaller than critical spacing (critical edge distance) the design loads have to be reduced.

- a) Max. recommended torque moment to avoid splitting failure during Installation with minimum spacing and edge distance
- b) h : base material thickness ($h \geq h_{min}$)
- c) The critical edge distance for concrete cone failure depends on the embedment depth h_{ef} and the design bond resistance. The simplified formula given in this table is on the safe side.

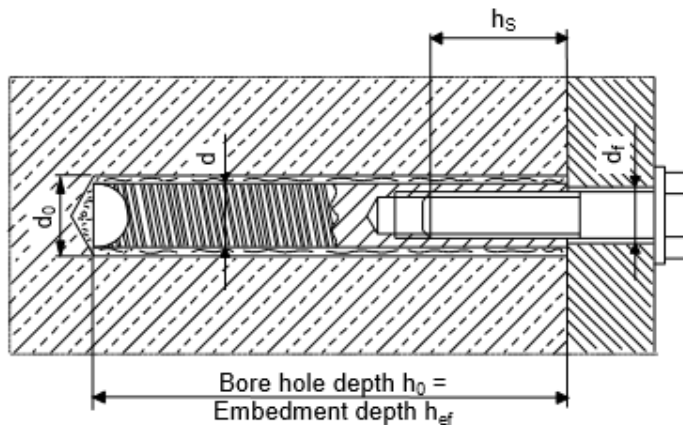
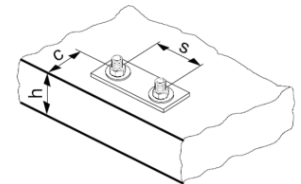

Settings details HIT-Z, HIT-Z-F and HIT-Z-R

Anchor size		M8	M10	M12	M16	M20
Nominal diameter of drill bit	d_0 [mm]	10	12	14	18	22
Length of anchor	min l [mm]	80	95	105	155	215
	max l [mm]	120	160	196	420	450
Nominal embedment depth range ^{a)}	$h_{nom,min}$ [mm]	60	60	60	96	100
	$h_{nom,max}$ [mm]	100	120	144	192	220
Borehole condition 1 Min. base material thickness	h_{min} [mm]	$h_{nom} + 60$ mm			$h_{nom} + 100$ mm	
Borehole condition 2 Min. base material thickness	h_{min} [mm]	$h_{nom} + 30$ mm ≥ 100 mm			$h_{nom} + 45$ mm ≥ 45 mm	
Maximum depth of drill hole	h_0 [mm]	$h - 30$ mm			$h - 2 d_0$	
Pre-setting: Diameter of clearance hole in the fixture	d_f [mm]	9	12	14	18	22
Through-setting: Diameter of clearance hole in the fixture	d_f [mm]	11	14	16	20	24
Maximum fixture thickness	t_{fix} [mm]	48	87	120	303	326
Maximum fixture thickness with seismic filling set	t_{fix} [mm]	41	79	111	292	314
Installation torque moment ^{b)}	T_{inst} [Nm]	10	25	40	80	150
Critical spacing for splitting failure	$s_{cr,sp}$ [mm]	$2 C_{cr,sp}$				
Critical edge distance for splitting failure ^{c)}	$c_{cr,sp}$ [mm]	$1,5 \cdot h_{nom}$ for $h / h_{nom} \geq 2,35$				
		$6,2 h_{nom} - 2,0 h$ for $2,35 > h / h_{nom} > 1,35$				
		$3,5 h_{nom}$ for $h / h_{nom} \leq 1,35$				
Critical spacing for concrete cone failure	$s_{cr,N}$ [mm]	$2 C_{cr,N}$				
Critical edge distance concrete cone failure ^{d)}	$c_{cr,N}$ [mm]	$1,5 h_{nom}$				

For spacing (edge distance) smaller than critical spacing (critical edge distance) the design loads have to be reduced.

- a) $h_{nom,min} \leq h_{nom} \leq h_{nom,max}$ (h_{nom} : embedment depth)
- b) Recommended torque moment to avoid splitting failure during installation with minimum spacing and edge distance
- c) h : base material thickness ($h \geq h_{min}$)
- d) The critical edge distance for concrete cone failure depends on the embedment depth h_{ef} and the design bond resistance. The simplified formula given in this table is on the safe side.

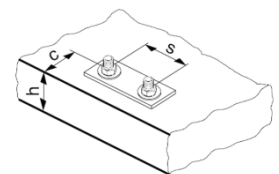

Pre-setting:

Install anchor before positioning fixture

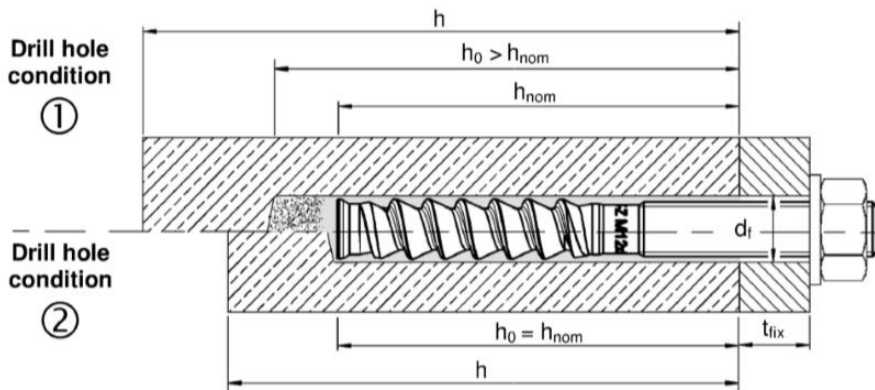

- Drill hole condition 1 → non-cleaned borehole
- Drill hole condition 2 → drilling dust is completely removed

Through-setting: Install anchor through positioned fixture

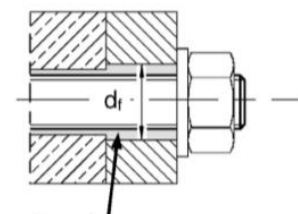

Annular gap filled with Hilti HIT-HY 200-A

Anchor dimension for HIT-Z

Anchor size		M8	M10	M12	M16	M20
Length of anchor	min l	80	95	105	155	215
	max l	120	160	196	420	450
Helix length	l_{Helix}	50	60	60	96	100

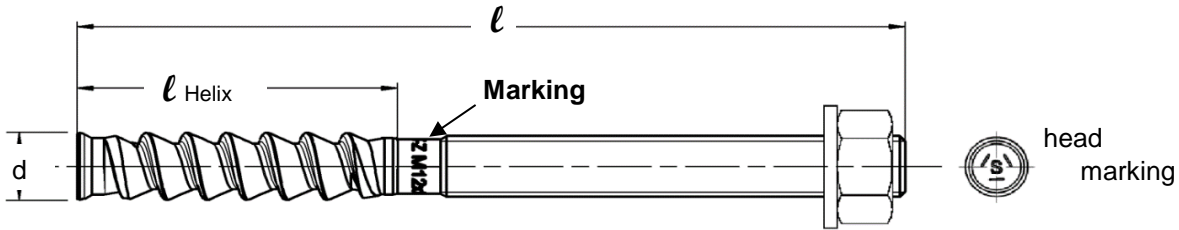

Minimum edge distance and spacing for HIT-Z

For the calculation of minimum spacing and minimum edge distance of anchors in combination with different embedment depth and thickness of concrete member the following equation shall be fulfilled: $A_{i,req} < A_{i,cal}$

Required interaction area $A_{i,cal}$ for HIT-Z

Anchor size		M8	M10	M12	M16	M20
Cracked concrete	[mm ²]	19200	40800	58800	94700	148000
Non-cracked concrete	[mm ²]	22200	57400	80800	128000	198000

Effective area $A_{i,ef}$ of HIT-Z

Member thickness $h \geq h_{nom} + 1,5 \cdot c$

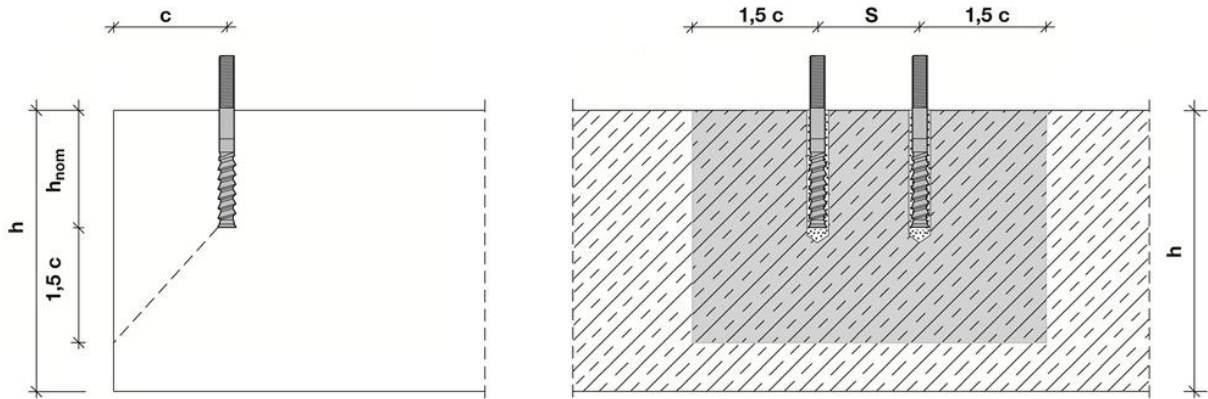

Single anchor and group of anchors with $s > 3 \cdot c$	[mm ²]	$A_{i,cal} = (6 \cdot c) \cdot (h_{nom} + 1,5 \cdot c)$	with $c \geq 5 \cdot d$
Group of anchors with $s \leq 3 \cdot c$	[mm ²]	$A_{i,cal} = (3 \cdot c + s) \cdot (h_{nom} + 1,5 \cdot c)$	with $c \geq 5 \cdot d$ and $s \geq 5 \cdot d$

Member thickness $h \leq h_{nom} + 1,5 \cdot c$

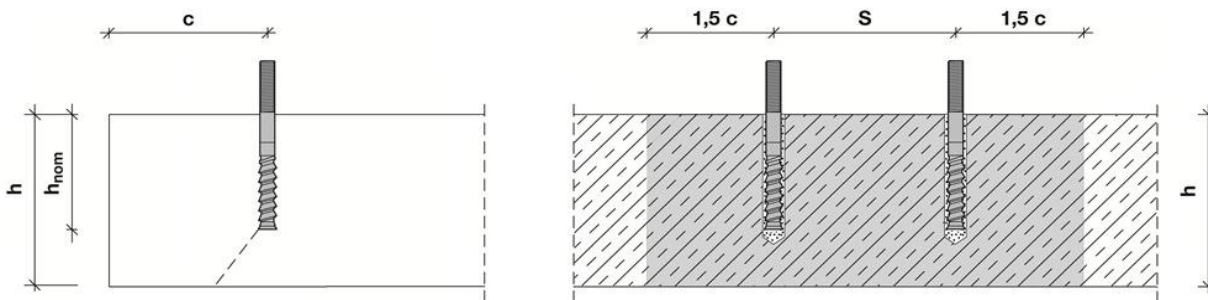

Single anchor and group of anchors with $s >$	[mm ²]	$A_{i,cal} = (6 \cdot c) \cdot h$	with $c \geq 5 \cdot d$
Group of anchors with $s \leq 3 \cdot c$	[mm ²]	$A_{i,cal} = (3 \cdot c + s) \cdot h$	with $c \geq 5 \cdot d$ and $s \geq 5 \cdot d$

Best case minimum edge distance and spacing with required member thickness and embedment depth

Anchor size		M8	M10	M12	M16	M20
Cracked concrete						
Member thickness	$h \geq$ [mm]	140	200	240	300	370
Embedment depth	$h_{nom} \geq$ [mm]	80	120	150	200	220
Minimum spacing	s_{min} [mm]	40	50	60	80	100
Corresponding edge distance	$c \geq$ [mm]	40	55	65	80	100
Minimum edge distance	$c_{min} =$ [mm]	40	50	60	80	100
Corresponding spacing	$s \geq$ [mm]	40	60	65	80	100
Non-cracked concrete						
Member thickness	$h \geq$ [mm]	140	230	270	340	410
Embedment depth	$h_{nom} \geq$ [mm]	80	120	150	200	220
Minimum spacing	s_{min} [mm]	40	50	60	80	100
Corresponding edge distance	$c \geq$ [mm]	40	70	80	100	130
Minimum edge distance	c_{min} [mm]	40	50	60	80	100
Corresponding spacing	$s \geq$ [mm]	40	145	160	160	235

Best case minimum member thickness and embedment depth with required minimum edge distance and spacing (borehole condition 1)

Anchor size		M8	M10	M12	M16	M20
Cracked concrete						
Member thickness	$h \geq$ [mm]	120	120	120	196	200
Embedment depth	$h_{nom} \geq$ [mm]	60	60	60	96	100
Minimum spacing	s_{min} [mm]	40	50	60	80	100
Corresponding edge distance	$c \geq$ [mm]	40	100	140	135	215
Minimum edge distance	$c_{min} =$ [mm]	40	60	90	80	125
Corresponding spacing	$s \geq$ [mm]	40	160	220	235	365
Non cracked concrete						
Member thickness	$h \geq$ [mm]	120	120	120	196	200
Embedment depth	$h_{nom} \geq$ [mm]	60	60	60	96	100
Minimum spacing	s_{min} [mm]	40	50	60	80	100
Corresponding edge distance	$c \geq$ [mm]	50	145	200	190	300
Minimum edge distance	c_{min} [mm]	40	80	115	110	165
Corresponding spacing	$s \geq$ [mm]	65	240	330	310	495

Minimum edge distance and spacing – Explanation

Minimum edge and spacing geometrical requirements are determined by testing the installation conditions in which two anchors with a given spacing can be set close to an edge without forming a crack in the concrete due to tightening torque.

The HIT-Z boundary conditions for edge and spacing geometry can be found in the tables to the left. If the embedment depth and slab thickness are equal to or greater than the values in the table, then the edge and spacing values may be utilized.

PROFIS Anchor software is programmed to calculate the referenced equations in order to determine the optimized related minimum edge and spacing based on the following variables:

Cracked or non-cracked concrete	For cracked concrete it is assumed that a reinforcement is present which limits the crack width to 0,3 mm, allowing smaller values for minimum edge distance and minimum spacing
Anchor diameter	For smaller anchor diameter a smaller installation torque is required, allowing smaller values for minimum edge distance and minimum spacing
Slab thickness and embedment depth	Increasing these values allows smaller values for minimum edge distance and minimum spacing

Installation equipment

Anchor size	M8	M10	M12	M16	M20	M24	M27	M30
Rotary hammer	HIT-V		TE 2 – TE 16			TE 40 - TE 80		
	HIT-Z		TE 2 – TE 40		TE 40 – TE 80		-	
	HIS-N		TE (-A) – TE 16(-A)		TE 40 – TE 80		-	
Other tools	compressed air gun and blow out pump, set of cleaning brushes, dispenser Hollow Drill Bit							

Cleaning, drilling and installation parameters

HIT-V	HIT-Z	HIS-N	Drill bit diameters d ₀ [mm]		Cleaning and installation	
			Hammer drill (HD)	Hollow Drill Bit (HDB)	Brush HIT-RB	Piston plug HIT-SZ
M8	M8	-	10	-	10	-
M10	M10	-	12	12	12	12
M12	M12	M8	14	14	14	14
M16	M16	M10	18	18	18	18
M20	M20	M12	22	22	22	22
M24	-	M16	28	28	28	28
M27	-	-	30	-	30	30
-	-	M20	32	32	32	32
M30	-	-	35	35	35	35

Setting instructions for HIT-V rods and HIS-N internally threaded sleeves

*For detailed information on installation see instruction for use given with the package of the product



Safety regulations.

Review the Material Safety Data Sheet (MSDS) before use for proper and safe handling! Wear well-fitting protective goggles and protective gloves when working with Hilti HIT-HY 200 A (R).

Drilling

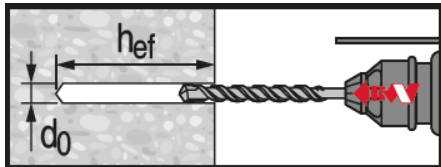

Hammer drilled hole (HD)

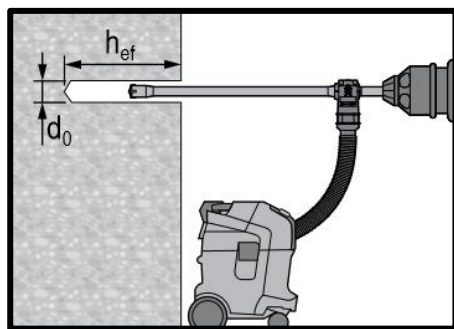

Hammer drilled hole with Hollow Drilled Bit (HDB)

No cleaning required

Cleaning

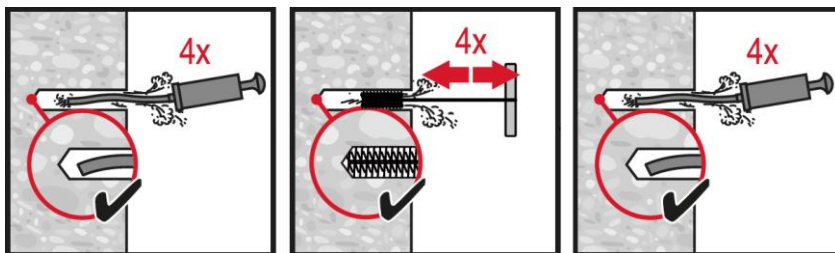

Manual cleaning (MC)

for drill diameters $d_0 \leq 20$ mm and drill hole depth $h_0 \leq 10 \cdot d$.



Compressed air cleaning (CAC)

for all drill hole diameters d_0 and drill hole depths $h_0 \leq 20 \cdot d$.

Injection

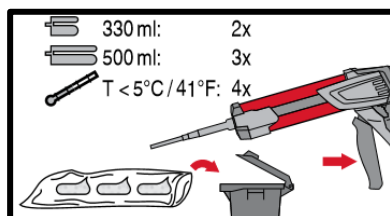
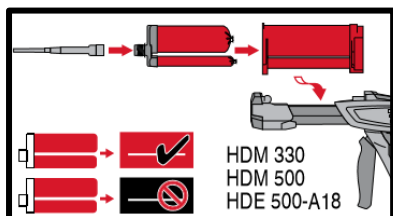

Injection system preparation.

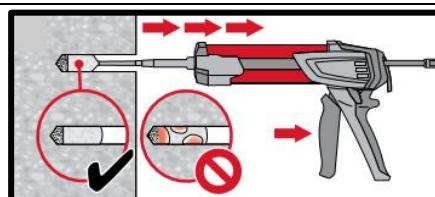
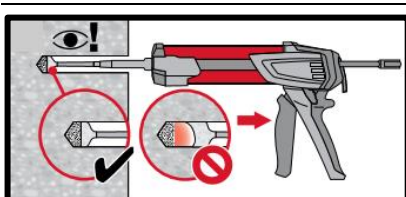

Injection method for drill hole depth $h_{ef} \leq 250$ mm.

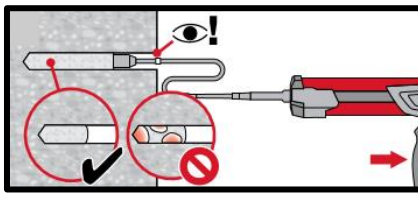
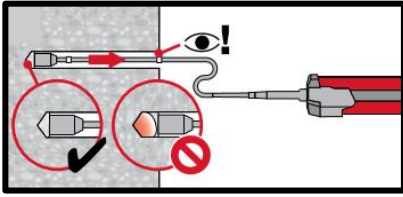

Injection method for drill hole depth $h_{ef} > 250\text{mm}$.

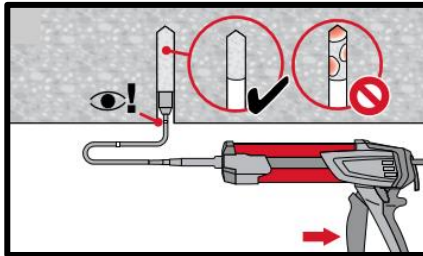
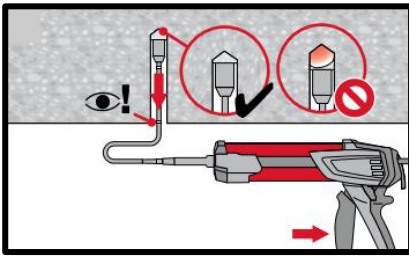

Injection method for overhead application and/or installation with embedment depth $> 250\text{ mm}$.

Setting the element

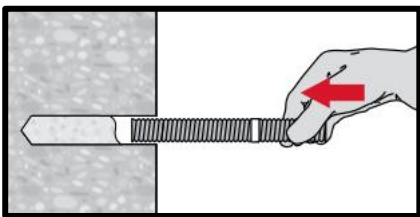

Setting element, observe working time " t_{work} ".

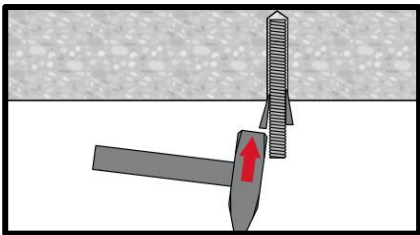

Setting element for overhead applications, observe working time " t_{work} ".

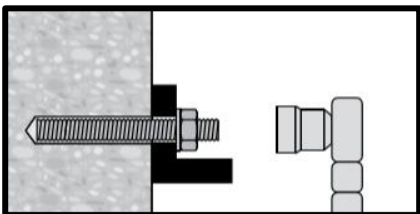

Loading the anchor after required curing time t_{cure}

Setting instructions for HIT-Z rods

*For detailed information on installation see instruction for use given with the package of the product.



Safety regulations.

Review the Material Safety Data Sheet (MSDS) before use for proper and safe handling! Wear well-fitting protective goggles and protective gloves when working with Hilti HIT-HY 200 A (R)

Drilling

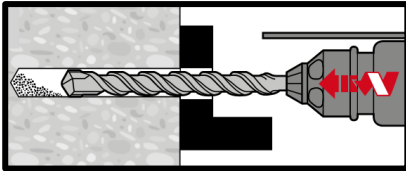

Hammer drilling: Through-setting

No cleaning required

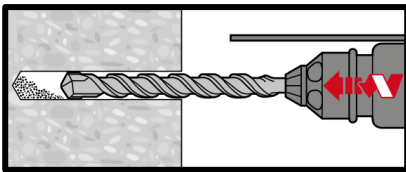

Hammer drilling: Pre-setting

No cleaning required

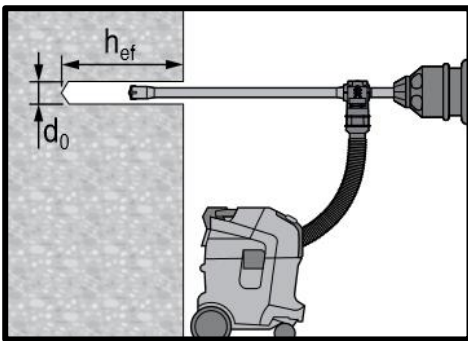

Hammer drilling with hollow drill bit: Through / pre-setting

No cleaning required

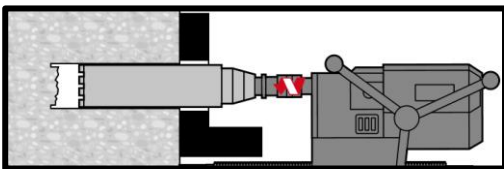

Diamond coring: Through-setting

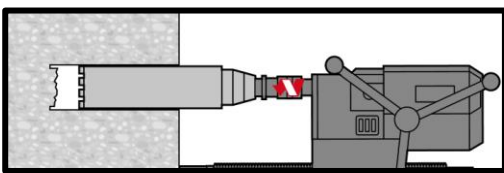

Diamond coring: Pre-setting

Cleaning

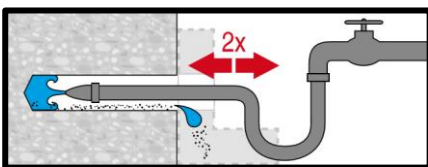

Hole flushing required for wet-drilled diamond cored holes.

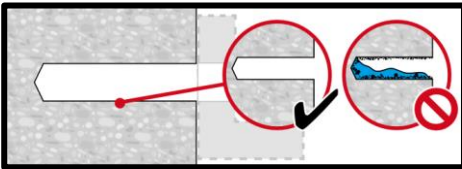
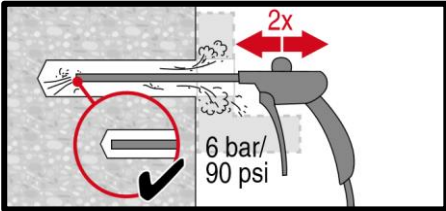

Evacuation required for wet-drilled diamond cored holes.

Injection

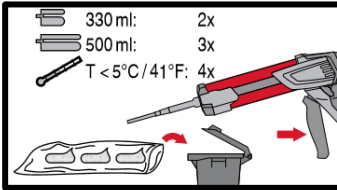
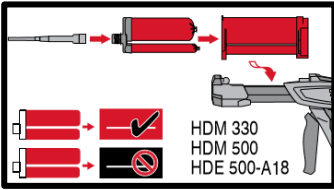

Injection system preparation.

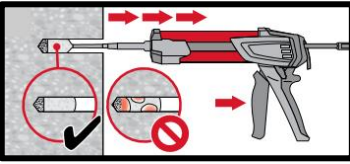
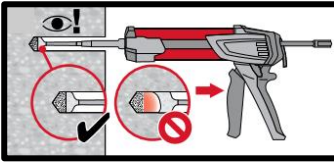

Injection of adhesive from the back of the drill hole without forming air voids.

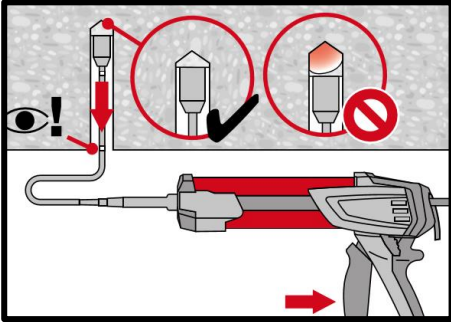

Overhead installation only with the aid of extensions and piston plugs.

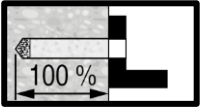

Through-setting:
Fill 100% of the drill hole.

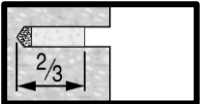

Pre-setting:
Fill approx. 2/3 of the drill hole.

Setting the element

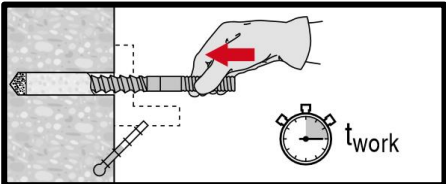

Setting element to the required embedment depth before working time "t_{work}" has elapsed.

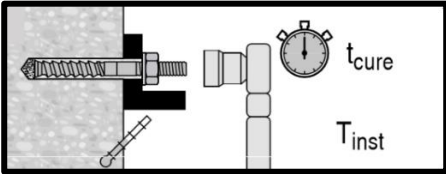

Loading the anchor: After required curing time t_{cure}.



Concrete

Chemical anchors

Mechanical anchors

Plastic/Light duty metal anchors

Insulation anchors

HIT-HY 200 injection mortar



Anchor design (ETAG 001) / Rebar elements / Concrete











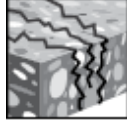

Concrete
Chemical anchors

Mechanical anchors

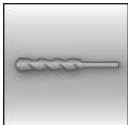
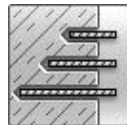
Plastic/Light duty metal anchors

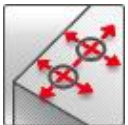
Insulation anchors

Injection mortar system	Benefits
 <p>Hilti HIT - HY 200-A 330 ml foil pack (also available as 500 ml foil pack)</p>	<ul style="list-style-type: none"> - SafeSet technology: drilling and borehole cleaning in one step with Hilti hollow drill bit - ETA seismic approval C1 - Suitable for cracked and non-cracked concrete C 12/15 to C 50/60 - Suitable for dry and water saturated concrete - High loading capacity, excellent handling - Small edge distance and anchor spacing possible - In service temperature range up to 120°C short term / 72°C long term - Large diameter applications - Two mortar versions: HY 200-R for slow cure applications and HY 200-A for fast cure applications
 <p>Hilti HIT - HY 200-R 330 ml foil pack (also available as 500 ml foil pack)</p>	
 <p>Rebar B500 B ($\phi 8$ - $\phi 32$)</p>	

Base material	Load conditions					
						
Concrete (non-cracked)	Concrete (cracked)	Dry concrete	Wet concrete	Static/ quasi-static	Seismic, ETA-C1	Fire resistance
Installation conditions			Other informations			
						
Hammer drilling	Variable embedment depth	Hilti SafeSet technology	Small edge distance and spacing	European Technical Assessment	CE conformity	PROFIS Rebar design Software

Approvals / certificates

Description	Authority / Laboratory	No. / date of issue
European technical assessment ^{a)}	DIBt, Berlin	ETA-11/0493 / 2017-07-28
European technical assessment ^{a)}	DIBT, Berlin	ETA-12/0084 / 2017-02-03

^{a)} All data given in this section according to ETA-11/0493 issue 2017-07-28 and to ETA-12/0084 issue 2017-03-12.

Static and quasi-static loading (for a single anchor)

All data in this section applies to

- Correct setting (See setting instruction)
- No edge distance and spacing influence
- Steel failure
- Base material thickness, as specified in the table
- One typical embedment depth, as specified in the table
- One anchor material, as specified in the tables
- Concrete C 20/25, $f_{ck,cube} = 25 \text{ N/mm}^2$
- Temperature range I
(min. base material temperature -40°C , max. long term/short term base material temperature: $+24^\circ\text{C}/40^\circ\text{C}$)

Embedment depth and base material thickness for static and quasi-static loading data

Anchor- size	$\phi 8$	$\phi 10$	$\phi 12$	$\phi 14$	$\phi 16$	$\phi 20$	$\phi 25$	$\phi 26$	$\phi 28$	$\phi 30$	$\phi 32$
Typical embedment depth [mm]	80	90	110	125	145	170	210	230	270	285	300
Base material thickness [mm]	110	120	145	165	185	220	275	295	340	360	380

Characteristic resistance

Anchor- size	$\phi 8$	$\phi 10$	$\phi 12$	$\phi 14$	$\phi 16$	$\phi 20$	$\phi 25$	$\phi 26$	$\phi 28$	$\phi 30$	$\phi 32$
Non-cracked concrete											
Tensile N_{Rk}	24,1	33,9	49,8	66,0	70,6	111,9	153,7	187,8	224,0	224,0	262,4
Shear V_{Rk}	14,0	22,0	31,0	42,0	55,0	86,0	135,0	146,0	169,0	194,0	221,0
Cracked concrete											
Tensile N_{Rk}	-	14,1	29,0	38,5	44,0	74,8	109,6	133,9	159,7	159,7	187,1
Shear V_{Rk}	-	22,0	31,0	42,0	55,0	86,0	135,0	146,0	169,0	194,0	221,0

Design resistance

Anchor- size	$\phi 8$	$\phi 10$	$\phi 12$	$\phi 14$	$\phi 16$	$\phi 20$	$\phi 25$	$\phi 26$	$\phi 28$	$\phi 30$	$\phi 32$
Non-cracked concrete											
Tensile N_{Rd}	16,1	22,6	33,2	44,0	47,1	74,6	102,5	125,2	149,4	149,4	174,9
Shear V_{Rd}	9,3	14,7	20,7	28,0	36,7	57,3	90,0	97,3	112,7	129,3	147,3
Cracked concrete											
Tensile N_{Rd}	-	9,4	19,4	25,7	29,3	49,8	73,0	89,2	106,5	106,5	124,7
Shear V_{Rd}	-	14,7	20,7	28,0	36,7	57,3	90,0	97,3	112,7	129,3	147,3

Recommended loads

Anchor- size	$\phi 8$	$\phi 10$	$\phi 12$	$\phi 14$	$\phi 16$	$\phi 20$	$\phi 25$	$\phi 26$	$\phi 28$	$\phi 30$	$\phi 32$
Non-cracked concrete											
Tensile N_{Rec}	11,5	16,2	23,7	31,4	33,6	53,3	73,2	89,4	106,7	106,7	125,0
Shear V_{Rec}	6,7	10,5	14,8	20,0	26,2	41,0	64,3	69,5	80,5	92,4	105,2
Cracked concrete											
Tensile N_{Rec}	-	6,7	13,8	18,3	20,9	35,6	52,2	63,7	76,1	76,1	89,1
Shear V_{Rec}	-	10,5	14,8	20,0	26,2	41,0	64,3	69,5	80,5	92,4	105,2

With overall partial safety factor for action $\gamma=1,4$. The partial safety factors for action depend on the type of loading and shall be taken from national regulations.

Seismic loading (for a single anchor)

All data in this section applies to:

- Correct setting (See setting)
- No edge distance and spacing influence
- **Steel** failure
- Minimum base material thickness
- Concrete C 20/25, $f_{ck,cube} = 25 \text{ N/mm}^2$
- Temperature range I
(min, base material temperature -40°C , max, long term/short term base material temperature: $+24^\circ\text{C}/40^\circ\text{C}$)
- $\alpha_{gap} = 1,0$

Embedment depth and base material thickness in case of seismic performance category C1

Anchor- size	$\phi 8$	$\phi 10$	$\phi 12$	$\phi 14$	$\phi 16$	$\phi 20$	$\phi 25$	$\phi 26$	$\phi 28$	$\phi 30$	$\phi 32$
Typical embedment depth [mm]	-	90	110	125	145	170	210	230	270	285	300
Base material thickness [mm]	-	120	145	165	185	220	275	295	340	360	380

Characteristic resistance in case of seismic performance category C1

Anchor- size	$\phi 8$	$\phi 10$	$\phi 12$	$\phi 14$	$\phi 16$	$\phi 20$	$\phi 25$	$\phi 26$	$\phi 28$	$\phi 30$	$\phi 32$
Tensile $N_{Rk, seis}$ [kN]	-	12,4	25,3	33,5	38,3	65,2	93,1	113,8	135,8	135,8	159,0
Shear $V_{Rk, seis}$	-	15,0	22,0	29,0	39,0	60,0	95,0	102,0	118,0	136,0	155,0

Design resistance in case of seismic performance category C1

Anchor- size	$\phi 8$	$\phi 10$	$\phi 12$	$\phi 14$	$\phi 16$	$\phi 20$	$\phi 25$	$\phi 26$	$\phi 28$	$\phi 30$	$\phi 32$
Tensile $N_{Rd, seis}$ [kN]	-	8,3	16,9	22,4	25,6	43,4	62,1	75,8	90,5	90,5	106,0
Shear $V_{Rd, seis}$	-	10,0	14,7	19,3	26,0	40,0	63,3	68,0	78,7	90,7	103,3

Materials

Mechanical properties

Anchor size	$\phi 8$	$\phi 10$	$\phi 12$	$\phi 14$	$\phi 16$	$\phi 20$	$\phi 25$	$\phi 26$	$\phi 28$	$\phi 30$	$\phi 32$
Nominal tensile strength f_{uk} [N/mm ²]	550	550	550	550	550	550	550	550	550	550	550
Yield strength f_{yk} [N/mm ²]	500	500	500	500	500	500	500	550	500	550	500
Stressed cross-section A_s [mm ²]	50,3	78,5	113,1	153,9	201,1	314,2	490,9	530,9	615,8	706,9	804,2
Moment of resistance W [mm ³]	50,3	98,2	169,6	269,4	402,1	785,4	1534	1726	2155	2651	3217

Material quality

Part	Material
Rebar EN 1992-1-1:2004 and AC:2010	Bars and de-coiled rods class B or C according to NDP or NCL of EN 1992-1-1/NA:2013

Setting information

Installation temperature range

- 10°C to + 40°C

Service temperature range

Hilti HIT-HY 200 injection mortar may be applied in the temperature ranges given below, An elevated base material temperature may lead to a reduction of the design bond resistance,

Temperature range	Base material temperature	Max, long term base material temperature	Max, short term base material temperature
Temperature range I	-40 °C to + 40 °C	+ 24 °C	+ 40 °C
Temperature range II	-40 °C to + 80 °C	+ 50 °C	+ 80 °C
Temperature range III	-40 °C to + 120 °C	+ 72 °C	+ 120 °C

Max, short term base material temperature

Short term elevated base material temperatures are those that occur over brief intervals, e.g, as a result of diurnal cycling,

Max, long term base material temperature

Long term elevated base material temperatures are roughly constant over significant periods of time,

Curing and working time

Temperature of the base material	HIT-HY 200-A		HIT-HY 200-R	
	Maximum working time t_{work}	Minimum curing time t_{cure}	Maximum working time t_{work}	Minimum curing time t_{cure}
- 10°C < T_{BM} ≤ - 5°C	1,5 h	7 h	3 h	20 h
- 5°C < T_{BM} ≤ 0°C	50 min	4 h	2 h	8 h
0°C < T_{BM} ≤ 5°C	25 min	2 hour	1 h	4 h
5°C < T_{BM} ≤ 10°C	15 min	75 min	40 min	2,5 h
10°C < T_{BM} ≤ 20°C	7 min	45 min	15 min	1,5 h
20°C < T_{BM} ≤ 30°C	4 min	30 min	9 min	1 h
30°C < T_{BM} ≤ 40°C	3 min	30 min	6 min	1 h

Installation equipment

Anchor size	φ8	φ10	φ12	φ14	φ16	φ20	φ25	φ26	φ28	φ30	φ32
Rotary hammer	TE 2 (-A) – TE 16 (-A)					TE 40 – TE 80					
Other tools	Compressed air gun, blow out pump Set of cleaning brushes, dispenser										

Setting details

Anchor size	Ø8	Ø10	Ø12	Ø14	Ø16	Ø20	Ø25	Ø26	Ø28	Ø30	Ø32
Nominal diameter of drill bit d_0 [mm]	10 / 12 ^{a)}	12 / 14 ^{a)}	14 / 16 ^{a)}	18	20	25	32	32	35	37	40
Effective anchorage and drill hole depth range ^{b)}	$h_{ef,min}$ [mm]	60	60	70	75	80	90	100	104	112	120
	$h_{ef,max}$ [mm]	160	200	240	280	320	400	500	520	560	600
Minimum base material thickness h_{min} [mm]	$h_{ef} + 30 \text{ mm} \geq 100 \text{ mm}$			$h_{ef} + 2 d_0$							
Minimum spacing s_{min} [mm]	40	50	60	70	80	100	125	130	140	150	160
Minimum edge distance c_{min} [mm]	40	45	45	50	50	65	70	75	75	80	80
Critical spacing for splitting failure $s_{cr,sp}$ [mm]	$2 c_{cr,sp}$										
Critical edge distance for splitting failure ^{c)} $c_{cr,sp}$ [mm]	$1,0 \cdot h_{ef}$		for $h / h_{ef} \geq 2,0$								
	$4,6 h_{ef} - 1,8 h$		for $2,0 > h / h_{ef} > 1,3$								
	$2,26 h_{ef}$		for $h / h_{ef} \leq 1,3$								
Critical spacing for concrete cone failure $s_{cr,N}$ [mm]	$2 c_{cr,N}$										
Critical edge distance for concrete cone failure ^{d)} $c_{cr,N}$ [mm]	$1,5 h_{ef}$										

For spacing (edge distance) smaller than critical spacing (critical edge distance) the design loads have to be reduced,

- a) Both given values for drill bit diameter can be used
- b) $h_{ef,min} \leq h_{ef} \leq h_{ef,max}$ (h_{ef} : embedment depth)
- c) h : base material thickness ($h \geq h_{min}$)
- d) The critical edge distance for concrete cone failure depends on the embedment depth h_{ef} and the design bond resistance. The simplified formula given in this table is on the safe side.

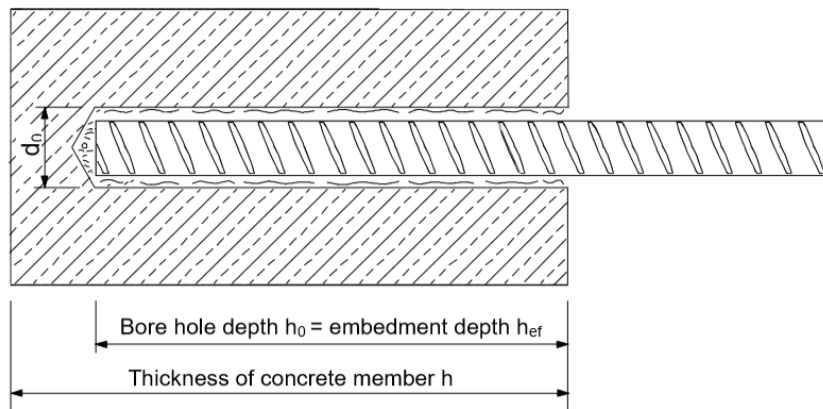
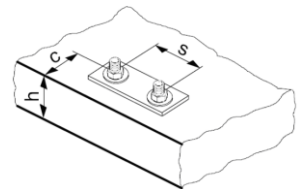

Rebar	Hammer drill (HD)	Hollow Drill Bit (HDB)	Brush HIT-RB
	d_0 [mm]		size [mm]
$\phi 8$	12 / 10 ^{a)}	12	12 / 10 ^{a)}
$\phi 10$	14 / 12 ^{a)}	14 / 12 ^{a)}	14 / 12 ^{a)}
$\phi 12$	16 / 14 ^{a)}	16 / 14 ^{a)}	16 / 14 ^{a)}
$\phi 14$	18	18	18
$\phi 16$	20	20	20
$\phi 20$	25	25	25
$\phi 25$	32	32	32
$\phi 26$	32	32	32
$\phi 28$	35	35	35
$\phi 30$	37	-	37
$\phi 32$	40	-	40

a) Both given values can be used

Setting instructions

*For detailed information on installation see instruction for use given with the package of the product,



Safety regulations.

Review the Material Safety Data Sheet (MSDS) before use for proper and safe handling! Wear well-fitting protective goggles and protective gloves when working with Hilti HIT-HY 200.

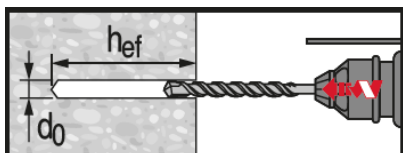

Hammer drilled hole (HD)

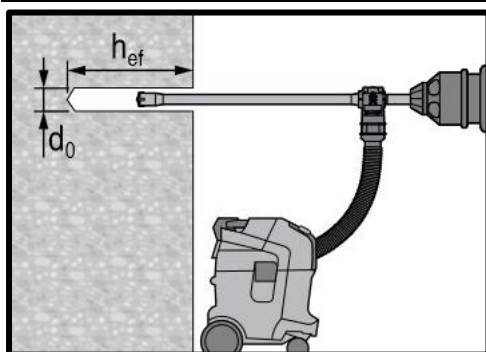

Hammer drilled hole with Hollow Drilled Bit (HDB)

No cleaning required

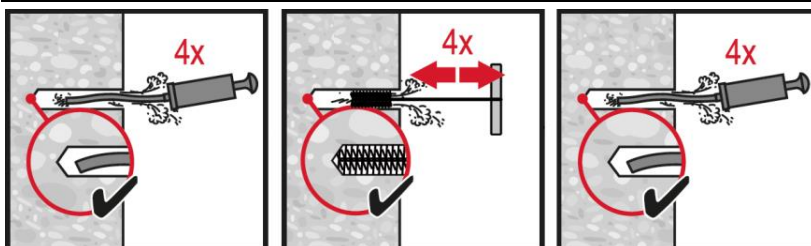

Manual cleaning (MC)

for drill diameters $d_0 \leq 20$ mm and drill hole depth $h_0 \leq 10 \cdot d_0$.

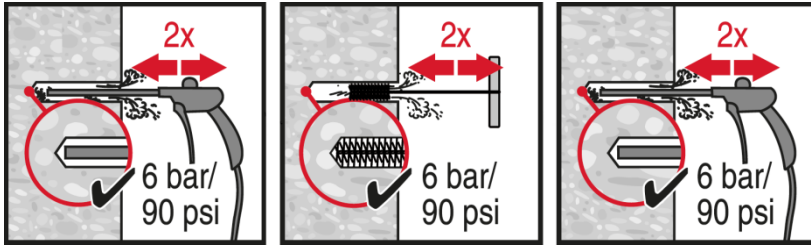

Compressed air cleaning (CAC)
for all drill hole diameters d_0 and drill hole depths $h_0 \leq 20 \cdot d$.

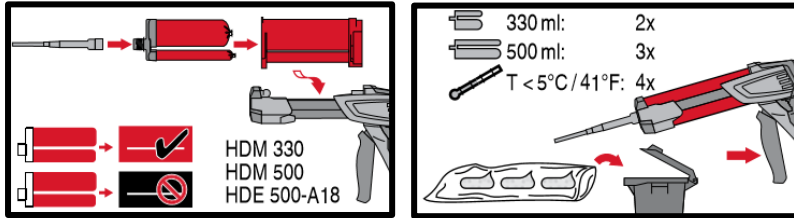

Injection system preparation.

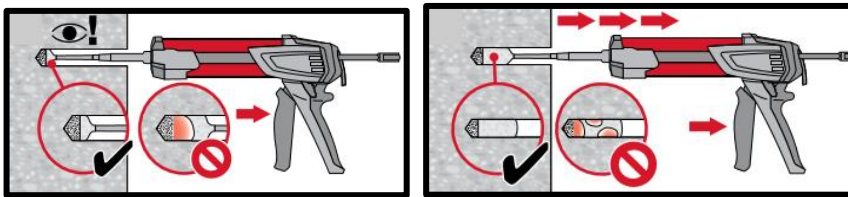

Injection method for drill hole depth
 $h_{ef} \leq 250$ mm.

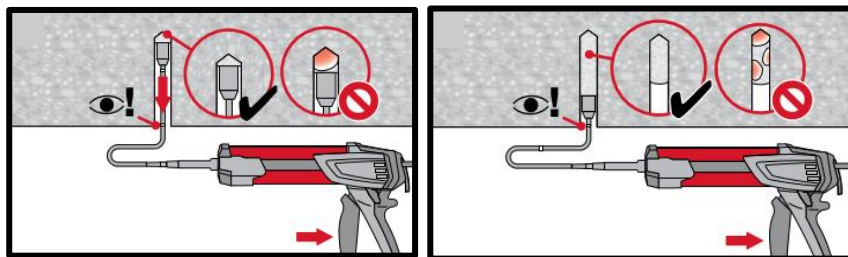

Injection method for overhead application and/or installations with embedment depth
 $h_{ef} \geq 250$ mm.

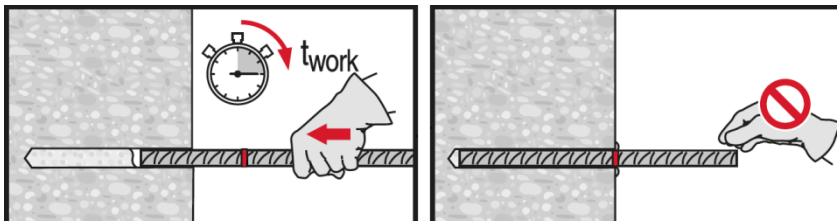

Setting element, observe working time
“ t_{work} ”.

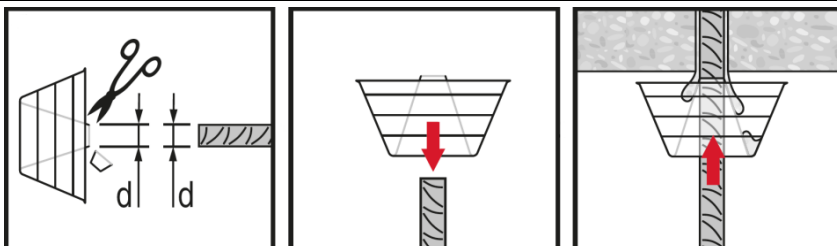

Setting element for overhead applications, observe working time
“ t_{work} ”.

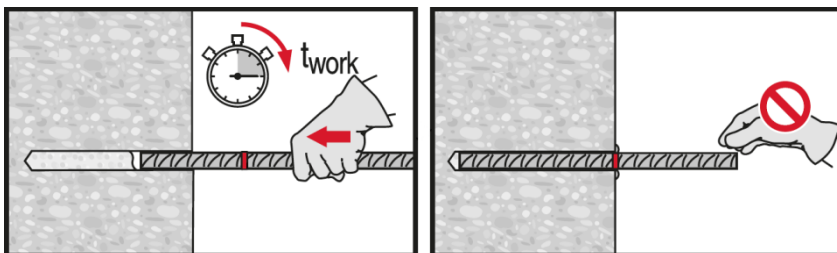

Setting element, observe working time
“ t_{work} ”.



Concrete

Chemical anchors

Mechanical anchors

Plastic/Light duty metal anchors

Insulation anchors

HIT-HY 200 injection mortar

Rebar design (EN 1992-1) / Rebar elements / Concrete

Concrete

Chemical anchors

Mechanical anchors

Plastic/Light duty metal anchors

Insulation anchors

Injection mortar system



Hilti HIT-HY 200-R
330 ml foil pack
(also available as
500 ml foil pack)



Hilti HIT-HY 200-A
330 ml foil pack
(also available as
500 ml foil pack)



Rebar
(φ8 - φ32)

Benefits

- **SafeSet** technology: Hilti hollow drill bit for hammer drilling
- HY 200-R version is formulated for best handling and cure time specifically for rebar applications
- Approved for ETA seismic C1 approval for post-installed-rebar
- Suitable for concrete C 12/15 to C 50/60
- Suitable for dry and water saturated concrete
- For rebar diameters up to 32 mm
- Non corrosive to rebar elements
- Good load capacity at elevated temperatures
- Suitable for embedment length up to 1000 mm
- Suitable for applications down to -10 °C
- Two mortar versions: HY 200-A for slow cure applications and HY 200-R for fast cure applications

Base material



Concrete
(non-cracked)

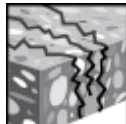

Concrete
(cracked)

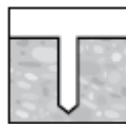

Dry concrete



Wet
concrete

Load conditions



Static/
quasi-static



Seismic,
CSTB¹/ETA-C1²



Fire resistance

Installation conditions

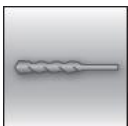

Hammer
drilling



Hilti SafeSet
technology

Other informations



European
Technical
Assessment



CE
conformity



PROFIS Rebar
design
Software

¹Seismic data only valid for HY 200-A

²Seismic data only valid for HY 200 R

Approvals / certificates

Description	Authority / Laboratory	No. / date of issue
European technical Assessment ^{a)}	DIBt, Berlin	ETA-11/0492/ 2014-06-26 (HY200 A)
European technical Assessment ^{a)}	DIBt, Berlin	ETA-12/0083/ 2018-06-26 (HY200 R)
Assessment (fire)	CSTB, Marne la Vallée	Z-21.8-1948 / 2013-11-14 (HY200 A)
Assessment (fire)	CSTB, Marne la Vallée	Z-21.8-1947 / 2014-07-22 (HY200 R)

^{a)} All data given in this section according to ETA-11/0492, issue 2014-06-26 and ETA-12/0083, issue 2014-06-26,.

Static and quasi-static loading

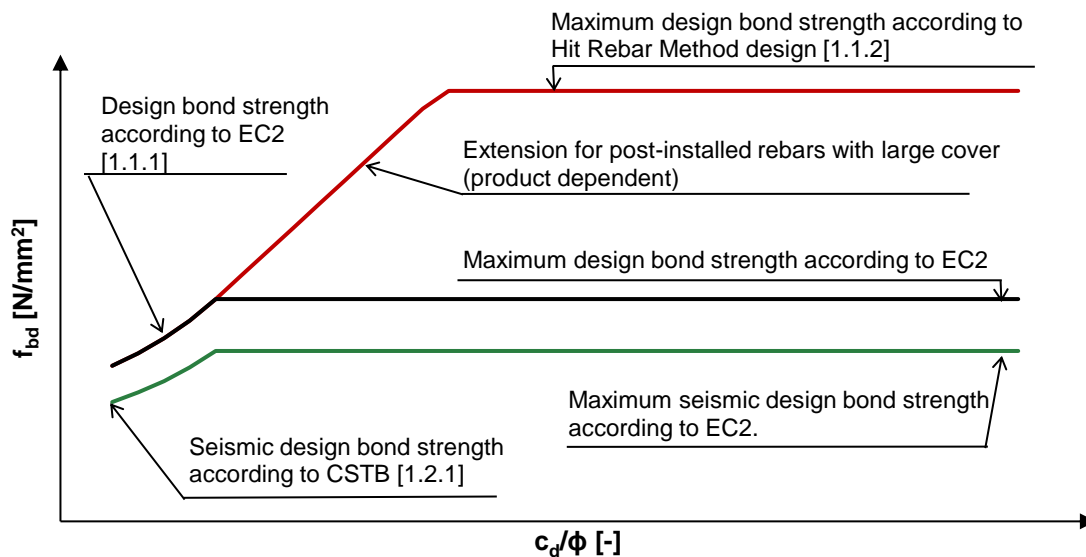

Effective limit on bond stress for post-installed rebar using Hilti mortar systems and design bond strength values as provided by the EC2.

Static EC2 design (small concrete cover)

Design bond strength in N/mm² for good bond conditions

All allowed drilling methods									
Rebar - size	Concrete class								
	C12/15	C16/20	C20/25	C25/30	C30/37	C35/45	C40/50	C45/55	C50/60
φ8 - φ32	1,6	2,0	2,3	2,7	3,0	3,4	3,7	4,0	4,3

For poor bond conditions multiply the values by 0,7. Values valid for non-cracked and cracked concrete.

Static Hit Rebar Method design (large concrete cover)

Maximum design bond strength in N/mm² for good bond conditions

Non-cracked concrete, all allowed drilling methods									
Temperature range	Rebar - size	Concrete class							
		C20/25	C25/30	C30/37	C35/45	C40/45	C45/55	C50/60	
I: 40°C/24°C	φ8 - φ32	8	8,2	8,3	8,4	8,6	8,7	8,8	
II: 58°C/35°C		6,7	6,8	6,9	7,0	7,1	7,2	7,3	
III: 70°C/43°C		5,7	5,8	5,9	6,0	6,1	6,1	6,2	
Cracked concrete, all allowed drilling methods									
I: 40°C/24°C	φ12 - φ32	4,7	4,8	4,8	4,9	5,0	5,1	5,1	
II: 58°C/35°C		3,7	3,7	3,8	3,9	3,9	4,0	4,0	
III: 70°C/43°C		3,3	3,4	3,5	3,5	3,6	3,6	3,7	

For poor bond conditions multiply the values by 0,7. *The reduction factor for rebar diameter equal to 10 mm is 0,72

Additional Hilti Technical Data:

Reduction factor for splitting with large concrete cover: $\delta = 0,306$ (Hilti additional data)

Minimum anchorage length and minimum lap length

The minimum anchorage length $\ell_{b,min}$ and the minimum lap length $\ell_{0,min}$ according to EN 1992-1-1 shall be multiplied by relevant **Amplification factor α_{lb}** in the table below.

Amplification factor α_{lb} for the min. anchorage length and min. lap length for
All allowed hammer drilling methods

Rebar - size	Concrete class								
	C12/15	C16/20	C20/25	C25/30	C30/37	C35/45	C40/50	C45/55	C50/60
$\phi 8 - \phi 32$	1,0								

Anchorage length for characteristic steel strength $f_{yk}=500 \text{ N/mm}^2$ for good conditions
All allowed drilling methods

Rebar-size	Concrete class	Yielding load [kN]	$l_{b,min}^{1)}$ [mm]	$l_{0,min}^{1)}$ [mm]	$l_{bd,y}^{2)}$ ($\alpha_2=1$) [mm]	$l_{bd,y}^{3)}$ ($\alpha_2=0.7$) [mm]	$l_{bd,y,HRM}^{4)}$ ($\alpha_2<0.7$) [mm]	$l_{max}^{5)}$ $-10^\circ\text{C} \leq c_t^{5)} \leq 0^\circ\text{C}$ [mm]	$l_{max}^{5)}$ $c_t^{5)} > 0^\circ\text{C}$ [mm]
$\phi 8$	C20/25	21,9	113	200	378	265	109	700	1000
$\phi 8$	C50/60	21,9	100	200	202	142	99	700	1000
$\phi 10$	C20/25	34,1	142	200	473	331	136	700	1000
$\phi 10$	C50/60	34,1	100	200	253	177	124	700	1000
$\phi 12$	C20/25	49,2	170	200	567	397	163	700	1000
$\phi 12$	C50/60	49,2	120	200	303	212	148	700	1000
$\phi 14$	C20/25	66,9	198	210	662	463	190	700	1000
$\phi 14$	C50/60	66,9	140	210	354	248	173	700	1000
$\phi 16$	C20/25	87,4	227	240	756	529	217	700	1000
$\phi 16$	C50/60	87,4	160	240	404	283	198	700	1000
$\phi 18$	C20/25	110,6	255	270	851	595	245	700	1000
$\phi 18$	C50/60	110,6	180	270	455	319	222	700	1000
$\phi 20$	C20/25	136,6	284	300	945	662	272	700	1000
$\phi 20$	C50/60	136,6	200	300	506	354	247	700	1000
$\phi 22$	C20/25	165,3	312	330	1040	728	299	700	1000
$\phi 22$	C50/60	165,3	220	330	556	389	272	700	1000
$\phi 24$	C20/25	196,7	340	360	1134	794	326	700	1000
$\phi 24$	C50/60	196,7	240	360	607	425	296	700	1000
$\phi 25$	C20/25	213,4	354	375	1181	827	340	700	1000
$\phi 25$	C50/60	213,4	250	375	632	442	309	700	1000
$\phi 26$	C20/25	230,8	369	390	1229	860	353	700	1000
$\phi 26$	C50/60	230,8	260	390	657	460	321	700	1000
$\phi 28$	C20/25	267,7	397	420	1323	926	380	700	1000
$\phi 28$	C50/60	267,7	280	420	708	495	346	700	1000
$\phi 30$	C20/25	307,3	425	450	1418	992	408	700	1000
$\phi 30$	C50/60	307,3	300	450	758	531	371	700	1000
$\phi 32$	C20/25	349,7	454	480	1512	1059	435	700	1000
$\phi 32$	C50/60	349,7	320	480	809	566	395	700	1000

1) According to EC2: EN 1992-1-1:2004 $l_{b,min}$ (8.6) and $l_{0,min}$ (8.11) are calculated for good bond conditions with characteristic yield strength $f_{yk} = 500 \text{ N/mm}^2$, $\gamma_M=1,15$ and $\alpha_6 = 1,0$

2) Embedment depth for yield of the rebar and for $c_d/\phi = 1$ (characteristic yield strength $f_{yk} = 500 \text{ N/mm}^2$)

3) Embedment depth for yield of the rebar and for $c_d/\phi = 3$ (characteristic yield strength $f_{yk} = 500 \text{ N/mm}^2$)

4) Embedment depth according to Hit Rebar design for yield of the rebar and for $c_d/\phi > 8$ (Temperature range I,

5) characteristic yield strength $f_{yk} = 500 \text{ N/mm}^2$)

6) c_t =concrete temperature

Seismic data

Seismic data according to ETA-12/0083 assessment

Seismic reduction factor $k_{b,seis}$ for hammer drilling (HD) and (HDB) and compressed air drilling (CA)

Rebar - size	Reduction factor $k_{b,seis}$							
	Concrete class							
	C16/20	C20/25	C25/30	C30/37	C35/45	C40/50	C45/55	C50/60
$\phi 12 - \phi 18$	1,0				0,90	0,82	0,76	0,71
$\phi 20 - \phi 30$	1,0						0,92	0,86
$\phi 32$	1,0							

For poor bond conditions multiply the values 0,7.

Design values for the ultimate bond resistance $f_{bd,seis}$ ¹⁾ in N/mm² for seismic loading for hammer drilling (HD) and (HDB) and compressed air drilling (CA)

Rebar - size	Bond resistance $f_{bd,seis}$							
	Concrete class							
	C16/20	C20/25	C25/30	C30/37	C35/45	C40/50	C45/55	C50/60
$\phi 12 - \phi 18$	2,0	2,3	2,7	3,0				
$\phi 20 - \phi 30$	2,0	2,3	2,7	3,0	3,4	3,7		
$\phi 32$	2,0	2,3	2,7	3,0	3,4	3,7	4,0	4,3

¹⁾ According to EN 1992-1-1:2004 for good bond conditions. For all other bond conditions multiply the values by 0.7.

Fire resistance

a) Anchoring application

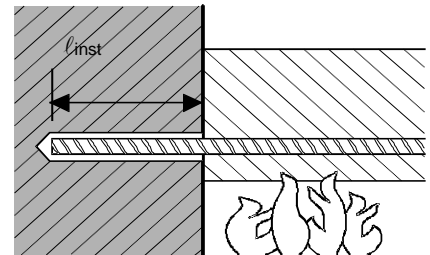

Maximum force ($F_{s,T,max}$) in rebar in conjunction with HIT-HY 200 as a function of embedment depth (l_{inst}) for the fire resistance classes F30 to F180 according to EC2.

Rebar-size	$F_{s,T,max}$ [kN]	l_{inst} [mm]	Fire resistance of bar [kN]					
			R30	R60	R90	R120	R180	
$\phi 8$	16,19	80	3,0	0,7	0,2	0,0	0,0	
		120	7,0	2,2	1,3	0,7	0,2	
		170	16,2	10,2	9,2	4,0	1,7	
		210		16,2	11,0	7,5		
		230			14,5	10,9		
		250			16,2	14,5		
		300				16,2		
$\phi 10$	25,29	100	6,1	2,0	1,0	0,4	0,0	
		150	19,3	9,3	7,1	2,2	1,0	
		190	25,3	18,0	15,9	9,3	4,9	
		230		25,3	24,7	18,1	13,7	
		260			25,3	24,7	20,3	
		280				25,3	24,7	24,7
		320					25,3	
$\phi 12$	36,42	120	15,3	6,0	1,9	1,1	0,3	
		180	31,0	19,0	17,8	8,5	7,0	

Maximum force ($F_{s,T,max}$) in rebar in conjunction with HIT-HY 200 as a function of embedment depth (ℓ_{inst}) for the fire resistance classes F30 to F180 according to EC2

$\phi 12$	36,42	220	36,4	29,6	27,0	19,1	13,8	
		260		29,7	24,4			
		280		36,4	36,4	35,0	29,6	
		300		36,4	34,9			
		340		36,4	36,4			
$\phi 14$	49,58	140	24,0	9,9	6,9	2,6	1,0	
		210	45,0	31,4	28,5	25,7	13,0	
		240	49,6	40,6	37,7	32,8	22,3	
		280		40,7	34,6			
		300		49,6	49,6	44,7	40,7	
		330		49,6	48,1			
		360		49,6	49,6			
$\phi 16$	64,75	160		34,5	18,4	14,9	4,4	2,3
		240		62,6	46,4	43,0	37,7	25,5
		260	64,8	53,5	50,0	44,7	32,5	
		300		64,8	57,0	51,7	49,6	
		330		64,8	61,3	57,2		
		360		64,8	64,8	62,7		
		400		64,8	64,8			
20	101,18	200		60,7	40,0	36,3	29,3	14,3
		250		78,3	62,5	58,3	51,3	36,3
		310	101,2	88,9	84,6	77,6	62,6	
		350		94,2	80,2			
		370		101,2	101,2	83,5		
		390		101,2	101,2	97,8		
		430		101,2	101,2			
		$\phi 25$		158,09	250	97,9	78,1	72,6
280	126,5				94,6	89,4	81,2	61,8
370	158,1				144,0	127,9	119,7	111,2
410			150,0		141,8	123,2		
430			158,1		158,1	150,0	144,2	
450			158,1		158,1	158,1	155,2	
500			158,1		158,1			
$\phi 32$		158,09	250	97,9	78,1	72,6	64,7	45,3
			280	126,5	94,6	89,4	81,2	61,8
	370		158,1	144,0	127,9	119,7	111,2	
	410			150,0	141,8	123,2		
	430			158,1	158,1	150,0	144,2	
	450			158,1	158,1	158,1	155,2	
	500			158,1	158,1			

Characteristic yield strength $f_{yk} = 500 \text{ N/mm}^2$

Steel failure

b) Overlap joint application

Max. bond stress, $f_{bd,FIRE}$, depending on actual clear concrete cover for classifying the fire resistance.

It must be verified that the actual force in the bar during a fire, $F_{s,T}$, can be taken up by the bar connection of the selected length, l_{inst} . Note: Cold design for ULS is mandatory.

$$F_{s,T} \leq (l_{inst} - c_f) \cdot \phi \cdot \pi \cdot f_{bd,FIRE} \quad \text{where: } (l_{inst} - c_f) \geq l_s;$$

l_s = lap length

ϕ = nominal diameter of bar

$l_{inst} - c_f$ = selected overlap joint length; this must be at least l_s ,

but may not be assumed to be more than 80ϕ

$f_{bd,FIRE}$ = bond stress when exposed to fire

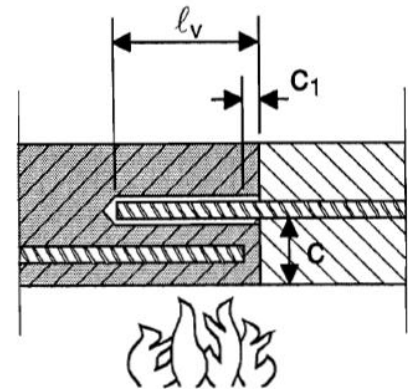

Critical temperature-dependent bond stress, τ_c , concerning “overlap joint” for Hilti HIT-HY 200 injection adhesive in relation to fire resistance class and required minimum concrete coverage c .

Clear concrete cover c [mm]	Max. bond stress, τ_c [N/mm ²]						
	R30	R60	R90	R120	R180		
30	0,6	0,3	-	-	-		
35	0,7	0,3					
40	0,9	0,4	0,2	-	-		
45	1,0	0,4	0,2				
50	1,2	0,5	0,3				
55	1,5	0,6	0,3	0,2	-		
60	1,8	0,8	0,4	0,3			
65	2,2	0,9	0,5	0,3			
70		1,0	0,5	0,3			
75		1,2	0,6	0,4		0,2	
80		1,5	0,7	0,5		0,3	
85		1,7	0,8	0,5		0,3	
90		2,0	1,0	0,6		0,3	
95		2,2	2,2	1,1		0,7	0,4
100				1,3		0,8	0,4
105				1,5	0,9	0,5	
110				1,7	1,1	0,5	
115	2,0			1,2	0,6		
120	2,2			2,2	1,4	0,6	
125					1,6	0,7	
130					1,9	0,8	
135					2,1	2,1	0,9
200	2,3						

Materials

Material quality

Part	Material
Rebar EN 1992-1-1	Bars and de-coiled rods class B or C with f_{yk} and k according to NDP or NCL of EN 1992-1-1 $f_{uk} = f_{tk} = k \cdot f_{yk}$

Fitness for use

Some creep tests have been conducted in accordance with ETAG guideline 001 part 5 and TR 023 in the following conditions: **in dry environment at 50 °C during 90 days.**

These tests show an excellent behaviour of the post-installed connection made with HIT-HY 200: low displacements with long term stability, failure load after exposure above reference load.

Resistance to chemical substances

Chemical	Resistance	Chemical	Resistance
Air	+	Gasoline	+
Acetic acid 10%	+	Glycole	o
Acetone	o	Hydrogen peroxide 10%	o
Ammonia 5%	+	Lactic acid 10%	+
Benzyl alcohol	-	Machinery oil	+
Chloric acid 10%	o	Methylethylketon	o
Chlorinated lime 10%	+	Nitric acid 10%	o
Citric acid 10%	+	Phosphoric acid 10%	+
Concrete plasticizer	+	Potassium Hydroxide pH 13,2	+
De-icing salt (Calcium chloride)	+	Sea water	+
Demineralized water	+	Sewage sludge	+
Diesel fuel	+	Sodium carbonate 10%	+
Drilling dust suspension pH 13,2	+	Sodium hypochlorite 2%	+
Ethanol 96%	-	Sulfuric acid 10%	+
Ethylacetate	-	Sulfuric acid 30%	+
Formic acid 10%	+	Toluene	o
Formwork oil	+	Xylene	o

- + resistant
- o resistant in short term (max. 48h) contact
- not resistant

Electrical Conductivity

HIT-HY 200 in the hardened state **is not conductive electrically**. Its electric resistivity is $15,5 \cdot 10^9 \Omega \cdot \text{cm}$ (DIN IEC 93 – 12.93). It is adapted well to realize electrically insulating anchoring (ex: railway applications, subway)

Setting information

Installation temperature range

-10°C to +40°C

Service temperature range

Hilti HIT-HY 200 injection mortar may be applied in the temperature ranges given below. An elevated base material temperature may lead to a reduction of the design bond resistance.

Temperature range	Base material temperature	Maximum long term base material temperature	Maximum short term base material temperature
Temperature range I	-40 °C to +80 °C	+50 °C	+80 °C

Max short term base material temperature

Short-term elevated base material temperatures are those that occur over brief intervals, e.g. as a result of diurnal cycling.

Max long term base material temperature

Long-term elevated base material temperatures are roughly constant over significant periods of time.

Curing and working time

Temperature of the base material	HIT-HY 200-A		HIT-HY 200-R	
	Maximum working time t_{work}	Minimum curing time t_{cure}	Maximum working time t_{work}	Minimum curing time t_{cure}
$-10^{\circ}\text{C} < T_{BM} \leq -5^{\circ}\text{C}$	1,5 h	7 h	3 h	20 h
$-5^{\circ}\text{C} < T_{BM} \leq 0^{\circ}\text{C}$	50 min	4 h	2 h	8 h
$0^{\circ}\text{C} < T_{BM} \leq 5^{\circ}\text{C}$	25 min	2 hour	1 h	4 h
$5^{\circ}\text{C} < T_{BM} \leq 10^{\circ}\text{C}$	15 min	75 min	40 min	2,5 h
$10^{\circ}\text{C} < T_{BM} \leq 20^{\circ}\text{C}$	7 min	45 min	15 min	1,5 h
$20^{\circ}\text{C} < T_{BM} \leq 30^{\circ}\text{C}$	4 min	30 min	9 min	1 h
$30^{\circ}\text{C} < T_{BM} \leq 40^{\circ}\text{C}$	3 min	30 min	6 min	1 h

Setting information

Installation equipment

Rebar – size	$\phi 8 - \phi 16$	$\phi 18 - \phi 32$
Rotary hammer	TE 2 (-A)– TE 40(-A)	TE40 – TE80
Other tools	Blow out pump ($h_{ef} \leq 10 \cdot d$)	-
	Compressed air gun ^{a)} Set of cleaning brushes ^{b)} , dispenser, piston plug	

a) Compressed air gun with extension hose for all drill holes deeper than 250 mm (for $\phi 8$ to $\phi 12$) or deeper than $20 \cdot \phi$ (for $\phi > 12$ mm)

b) Automatic brushing with round brush for all drill holes deeper than 250 mm (for $\phi 8$ to $\phi 12$) or deeper than $20 \cdot \phi$ (for $\phi > 12$ mm)

Minimum concrete cover c_{min} of the post-installed rebar

Drilling method	Bar diameter [mm]	Minimum concrete cover c_{min} [mm]	
		Without drilling aid	With drilling aid
Hammer drilling (HD) and (HDB)	$\phi < 25$	$30 + 0,06 \cdot l_v \geq 2 \cdot \phi$	$30 + 0,02 \cdot l_v \geq 2 \cdot \phi$
	$\phi \geq 25$	$40 + 0,06 \cdot l_v \geq 2 \cdot \phi$	$40 + 0,02 \cdot l_v \geq 2 \cdot \phi$
Compressed air drilling (CA)	$\phi < 25$	$50 + 0,08 \cdot l_v$	$50 + 0,02 \cdot l_v$
	$\phi \geq 25$	$60 + 0,08 \cdot l_v \geq 2 \cdot \phi$	$60 + 0,02 \cdot l_v \geq 2 \cdot \phi$

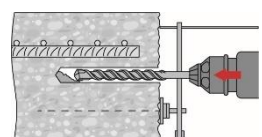

Drilling and cleaning diameters

Rebar [mm]	Hammer drill (HD)	Hollow Drill Bit (HDB) ^{b)}	Compressed air drill (CA)	Brush HIT-RB	Air nozzle HIT-RB
	d ₀ [mm]			size [mm]	
φ8	12 / 10 ^{a)}	12	-	12 / 10 ^{a)}	12 / 10 ^{a)}
φ10	14 / 12 ^{a)}	14 / 12 ^{a)}	-	14 / 12 ^{a)}	14 / 12 ^{a)}
φ12	16 / 14 ^{a)}	16 / 14 ^{a)}	-	16 / 14 ^{a)}	16 / 14 ^{a)}
	-	-	17	18	16
φ14	18	18	17	18	18
φ16	20	20	-	20	20
	-	-	20	22	20
φ18	22	22	22	22	22
φ20	25	25	-	25	25
	-	-	26	28	25
φ22	28	28	28	28	28
φ24	32	32	32	32	32
φ25	32	32	32	32	
φ26	35	-	35	35	
φ28	35	-	35	35	
φ30	-	-	35	35	
	37	-	-	37	
φ32	40	-	40	40	

a) Maximum installation length l=250 mm.

b) No cleaning required

Dispensers and corresponding maximum embedment depth $l_{v,max}$

Rebar	Dispenser	
	HDM 330, HDM 500, HDE 500	HDE 500
	Concrete temp. $\geq -10^{\circ}\text{C}$	Concrete temp. $\geq 0^{\circ}\text{C}$
	$l_{v,max}$ [mm]	$l_{v,max}$ [mm]
φ8 - φ32	700	1000

Setting instructions

*For detailed information on installation see instruction for use given with the package of the product.



Safety regulations.

Review the Material Safety Data Sheet (MSDS) before use for proper and safe handling! Wear well-fitting protective goggles and protective gloves when working with Hilti HIT-HY 200.

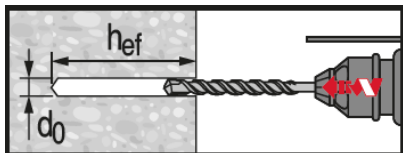

Hammer drilled hole (HD)

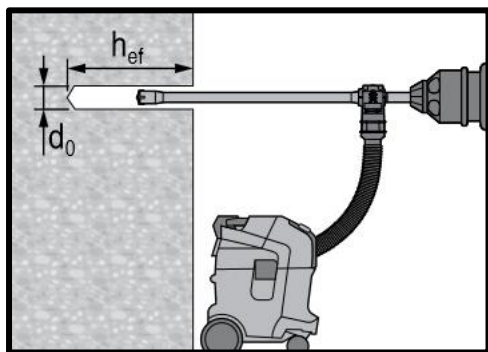

Hammer drilled hole with Hollow Drilled Bit (HDB)

No cleaning required

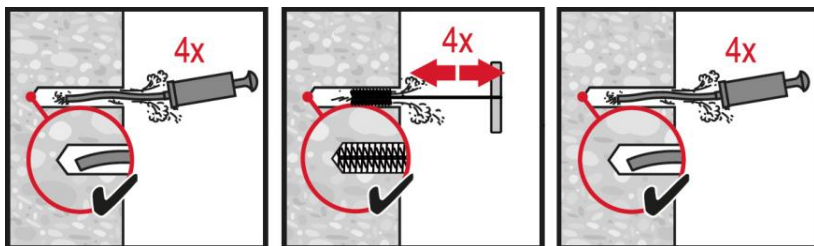

Manual cleaning (MC)

for drill diameters $d_0 \leq 20$ mm and drill hole depth $h_0 \leq 10 \cdot d$.

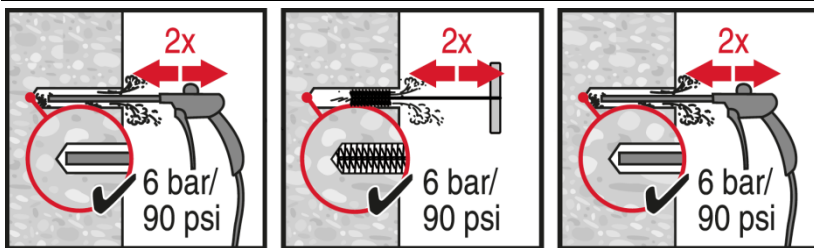

Compressed air cleaning (CAC)

for all drill hole diameters d_0 and drill hole depths $h_0 \leq 20 \cdot d$.

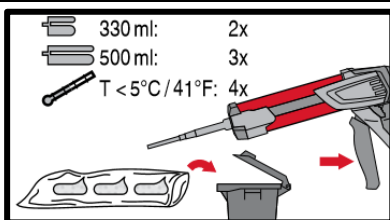
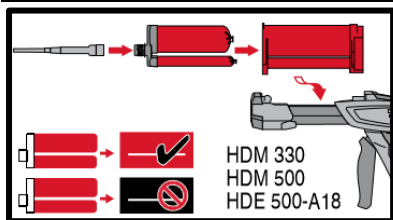

Injection system preparation.

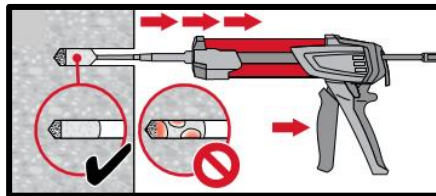
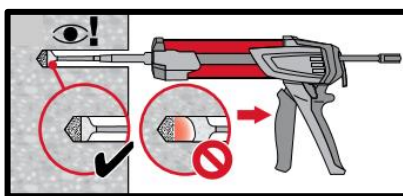

Injection method for drill hole depth $h_{ef} \leq 250$ mm.

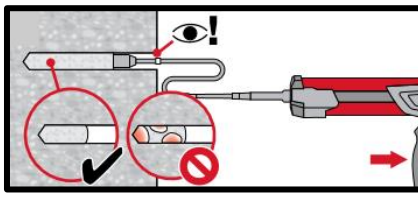
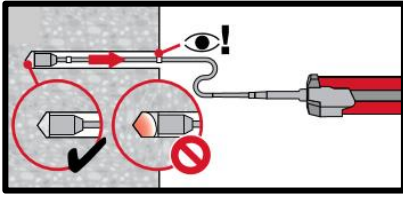

Injection method for drill hole depth $h_{ef} > 250\text{mm}$.

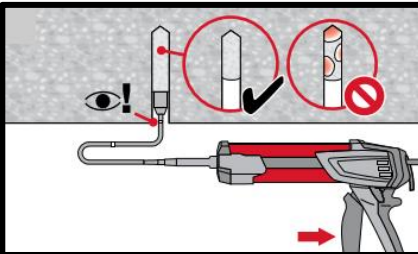
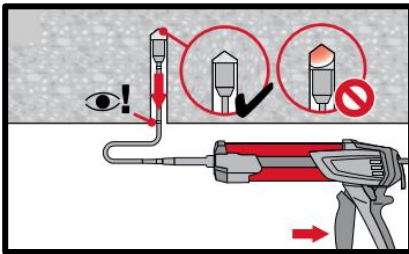

Injection method for overhead application.

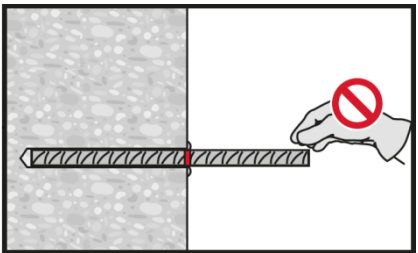
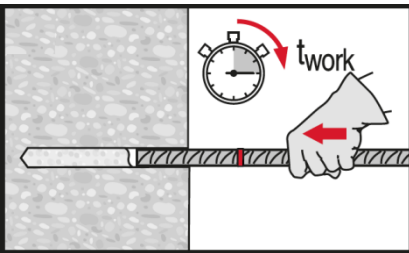

Setting element, observe working time " t_{work} ".

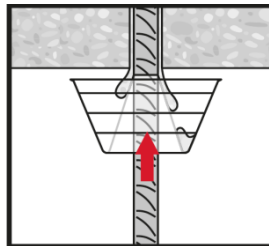
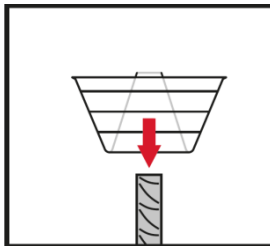
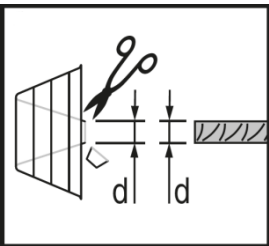

Setting element for overhead applications, observe working time " t_{work} ".

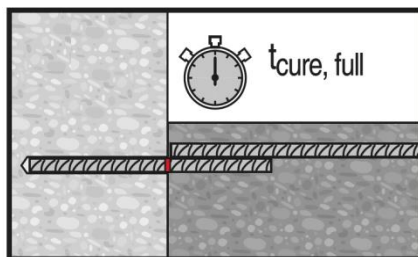
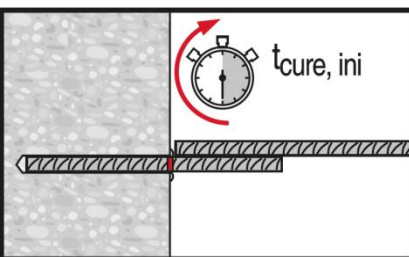
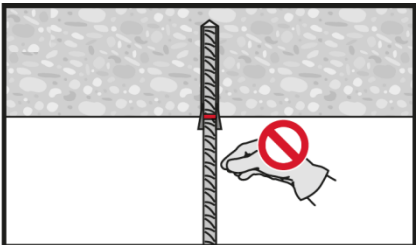
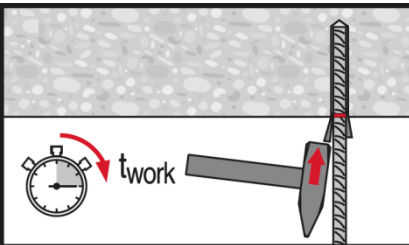

Apply full load only after curing time " t_{cure} ".



Concrete

Chemical anchors

Mechanical anchors

Plastic/Light duty metal anchors

Insulation anchors

HIT-RE 100 injection mortar

Anchor design (ETAG 001) / Rods&Sleeves / Concrete

Concrete

Chemical anchors

Mechanical anchors

Plastic/Light duty metal anchors

Insulation anchors

Injection mortar system



Hilti HIT-RE 100
500 ml foil pack
(also available as
330 ml foil pack)

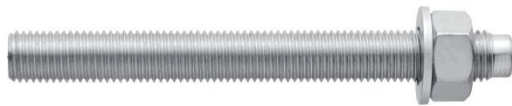

Anchor rods:
HIT-V
HIT-V-F
HIT-V-R
HIT-V-HCR
(M8-M30)

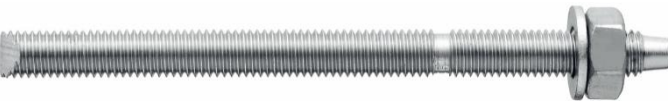

Anchor rods:
HAS-(E)
HAS-(E)-R
HAS-(E)-HCR
(M8-M30)

Benefits

- Suitable for cracked and non-cracked concrete C 20/25 to C 50/60
- High loading capacity
- Suitable for dry and water saturated concrete
- Large diameter applications
- Long working time at elevated temperatures
- Odourless epoxy

Base material



Concrete (non-cracked)

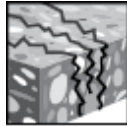

Concrete (cracked)

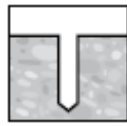

Dry concrete

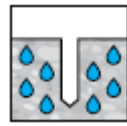

Wet concrete

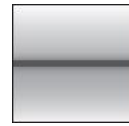

Static/
quasi-static

Load conditions

Installation conditions

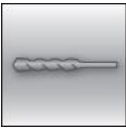

Hammer drilling

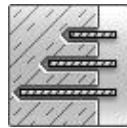

Variable embedment depth

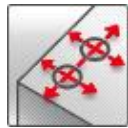

Small edge distance and spacing

SAFE-ET

Hilti **SafeSet** technology



European Technical Assessment



CE conformity

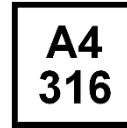

Corrosion resistance



High corrosion resistance

Other informations

Approvals / certificates

Description	Authority / Laboratory	No. / date of issue
European technical assessment ^{a)}	DIBt, Berlin	ETA-15/0882 / 2017-12-11

a) All data given in this section according to ETA-15/0882 issue 2017-12-11.

Static and quasi-static loading (for a single anchor)

All data in this section applies to

- Correct setting (See setting instruction)
- No edge distance and spacing influence
- Steel failure
- Anchor HIT-V and HAS-(E) with strength 5.8
- Base material thickness, as specified in the table
- One typical embedment depth, as specified in the table
- Concrete C 20/25, $f_{ck,cube} = 25 \text{ N/mm}^2$
- Temperate range I
(min. base material temperature -40°C , max. long term/short term base material temperature: $+24^\circ\text{C}/40^\circ\text{C}$)

Embedment depth and base material thickness

Anchor size		M8	M10	M12	M16	M20	M24	M27	M30
Typical embedment depth	[mm]	80	90	110	125	170	210	240	270
Base material thickness	[mm]	110	120	140	165	220	270	300	340

Characteristic resistance

Anchor size		M8	M10	M12	M16	M20	M24	M27	M30
Non-cracked concrete									
Tension N_{Rk}	HIT-V, HAS-(E) [kN]	18,3	29,0	42,2	70,6	111,9	153,7	187,8	224,0
Shear V_{Rk}	HIT-V, HAS-(E) [kN]	9,2	14,5	21,1	39,3	61,3	88,3	114,8	140,3
Cracked concrete									
Tension N_{Rk}	HIT-V, HAS-(E) [kN]	-	19,8	29,0	40,8	64,1	95,0	112,0	140,0
Shear V_{Rk}	HIT-V, HAS-(E) [kN]	-	14,5	21,1	39,3	61,3	88,3	114,8	140,3

Design resistance

Anchor size		M8	M10	M12	M16	M20	M24	M27	M30
Non-cracked concrete									
Tension N_{Rd}	HIT-V, HAS-(E) [kN]	12,2	19,3	27,7	33,6	53,3	73,2	89,4	106,7
Shear V_{Rd}	HIT-V, HAS-(E) [kN]	7,3	11,6	16,9	31,4	49,0	70,6	91,8	112,2
Cracked concrete									
Tension N_{Rd}	HIT-V, HAS-(E) [kN]	-	9,4	13,8	19,4	30,5	45,2	53,3	66,6
Shear V_{Rd}	HIT-V, HAS-(E) [kN]	-	11,6	16,9	31,4	49,0	70,6	91,8	112,2

Recommended loads ^{a)}

Anchor size		M8	M10	M12	M16	M20	M24	M27	M30
Non-cracked concrete									
Tension N_{Rec}	HIT-V, HAS-(E) [kN]	8,7	13,8	19,8	24,0	38,1	52,3	63,9	76,2
Shear V_{Rec}	HIT-V, HAS-(E) [kN]	5,2	8,3	12,0	22,4	35,0	50,4	65,6	80,1
Cracked concrete									
Tension N_{Rec}	HIT-V, HAS-(E) [kN]	-	6,7	9,9	13,9	21,8	32,3	38,1	47,6
Shear V_{Rec}	HIT-V, HAS-(E) [kN]	-	8,3	12,0	22,4	35,0	50,4	65,6	80,1

a) With overall partial safety factor for action $\gamma=1,4$. The partial safety factors for action depend on the type of loading and shall be taken from national regulations.

Materials

Mechanical properties

Anchor size		M8	M10	M12	M16	M20	M24	M27	M30
Nominal tensile strength f_{uk}	HIT-V 5.8 HAS-(E) 5.8 [N/mm ²]	500	500	500	500	500	500	500	500
	HIT-V 8.8 HAS-(E) 8.8 [N/mm ²]	800	800	800	800	800	800	800	800
	HIT-V-R HAS-(E)R [N/mm ²]	700	700	700	700	700	700	500	500
	HIT-V-HCR HAS-(E)HCR [N/mm ²]	800	800	800	800	800	700	700	700
Yield strength f_{yk}	HIT-V 5.8 HAS-(E) 5.8 [N/mm ²]	400	400	400	400	400	400	400	400
	HIT-V 8.8 HAS-(E) 8.8 [N/mm ²]	640	640	640	640	640	640	640	640
	HIT-V-R HAS-(E)R [N/mm ²]	450	450	450	450	450	450	210	210
	HIT-V-HCR HAS-(E)HCR [N/mm ²]	640	640	640	640	640	400	400	400
Stressed cross-section A_s	HIT-V [mm ²]	36,6	58,0	84,3	157	245	353	459	561
	HAS-(E) [mm ²]	32,8	52,3	76,2	144,0	225,0	324,0	427,0	519,0
Moment of resistance W	HIT-V [mm ³]	31,2	62,3	109	277	541	935	1387	1874
	HAS-(E) [mm ³]	27,0	54,1	93,8	244,0	474,0	809,0	1274,0	1706,0

Material quality for HIT-V

Part	Material
Zinc coated steel	
Threaded rod, HIT-V 5.8 (F) HAS-(E) 5.8	Strength class 5.8; Elongation at fracture A5 > 8% ductile Electroplated zinc coated $\geq 5\mu\text{m}$; (F) hot dip galvanized $\geq 45\mu\text{m}$
Threaded rod, HIT-V 8.8 (F) HAS-(E) 8.8	Strength class 8.8; Elongation at fracture A5 > 12% ductile Electroplated zinc coated $\geq 5\mu\text{m}$; (F) hot dip galvanized $\geq 45\mu\text{m}$
Washer	Electroplated zinc coated $\geq 5\mu\text{m}$, hot dip galvanized $\geq 45\mu\text{m}$
Nut	Strength class of nut adapted to strength class of threaded rod. Electroplated zinc coated $\geq 5\mu\text{m}$, hot dip galvanized $\geq 45\mu\text{m}$
Stainless Steel	
Threaded rod, HIT-V-R HAS-(E)-R	Strength class 70 for $\leq M24$ and strength class 50 for $> M24$; Elongation at fracture A5 > 8% ductile Stainless steel 1.4401; 1.4404; 1.4578; 1.4571; 1.4439; 1.4362
Washer	Stainless steel 1.4401, 1.4404, 1.4578, 1.4571, 1.4439, 1.4362 EN 10088-1:2014
Nut	Stainless steel 1.4401, 1.4404, 1.4578, 1.4571, 1.4439, 1.4362 EN 10088-1:2014
High corrosion resistant steel	
Threaded rod, HIT-V-HCR HAS-(E)-HCR	Strength class 80 for $\leq M20$ and class 70 for $> M20$, Elongation at fracture A5 > 8% ductile High corrosion resistance steel 1.4529; 1.4565;
Washer	High corrosion resistant steel 1.4529, 1.4565 EN 10088-1:2014
Nut	High corrosion resistant steel 1.4529, 1.4565 EN 10088-1:2014

Setting information

Installation temperature range:

+5°C to +40°C

Service temperature range

Hilti HIT-RE 100 injection mortar may be applied in the temperature ranges given below. An elevated base material temperature may lead to a reduction of the design bond resistance.

Temperature range	Base material temperature	Max. long term base material temperature	Max. short term base material temperature
Temperature range I	-40 °C to + 40 °C	+ 24 °C	+ 40 °C
Temperature range II	-40 °C to + 58 °C	+ 35 °C	+ 58 °C
Temperature range III	-40 °C to + 70 °C	+ 43 °C	+ 70 °C

Max. short term base material temperature

Short term elevated base material temperatures are those that occur over brief intervals, e.g. as a result of diurnal cycling.

Max. long term base material temperature

Long term elevated base material temperatures are roughly constant over significant periods of time.

Working time and curing time

Temperature of the base material	Max. working time in which rebar can be inserted and adjusted t_{work}	Min. curing time before rebar can be fully loaded t_{cure}
$5\text{ °C} \leq T_{BM} < 10\text{ °C}$	2 h	72 h
$10\text{ °C} \leq T_{BM} < 15\text{ °C}$	1,5 h	48 h
$15\text{ °C} \leq T_{BM} < 20\text{ °C}$	30 min	24 h
$20\text{ °C} \leq T_{BM} < 30\text{ °C}$	20 min	12 h
$30\text{ °C} \leq T_{BM} < 40\text{ °C}$	12 min	8 h
40 °C	12 min	4 h

The curing time data are valid for dry base material only. In wet base material the curing times must be doubled.

Setting details

Anchor size	M8	M10	M12	M16	M20	M24	M27	M30
Nominal diameter of drill bit d_0 [mm]	10	12	14	18	22	28	30	35
Diameter of element d [mm]	8	10	12	16	20	24	27	30
Effective anchorage and drill hole depth h_{ef} [mm]	60 to 160	60 to 200	70 to 240	80 to 320	90 to 400	96 to 480	108 to 540	120 to 600
Minimum base material thickness h_{min} [mm]	$h_{ef} + 30 \geq 100$ mm			$h_{ef} + 2 d_0$				
Diameter of clearance hole in the fixture d_f [mm]	9	12	14	18	22	26	30	33
Minimum spacing s_{min} [mm]	40	50	60	80	100	120	135	150
Minimum edge distance c_{min} [mm]	40	50	60	80	100	120	135	150
Critical spacing for splitting failure $s_{cr,sp}$ [mm]	$2 C_{cr,sp}$							
Critical edge distance for splitting failure ^{a)} $c_{cr,sp}$ [mm]	$1,0 \cdot h_{ef}$ for $h / h_{ef} \geq 2,0$							
	$4,6 h_{ef} - 1,8 h$ for $2,0 > h / h_{ef} > 1,3$							
	$2,26 h_{ef}$ for $h / h_{ef} \leq 1,3$							
Critical spacing for concrete cone failure $s_{cr,N}$ [mm]	$2 C_{cr,N}$							
Critical edge distance for concrete cone failure ^{b)} $c_{cr,N}$ [mm]	$1,5 h_{ef}$							
Torque moment ^{c)} T_{max} [Nm]	10	20	40	80	150	200	270	300

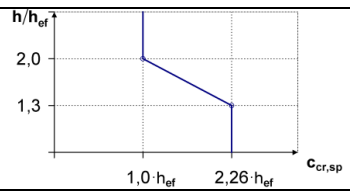

For spacing (edge distance) smaller than critical spacing (critical edge distance) the design loads have to be reduced.

- a) $h_{ef,min} \leq h_{ef} \leq h_{ef,max}$ (h_{ef} : embedment depth) h : base material thickness ($h \geq h_{min}$)
- b) The critical edge distance for concrete cone failure depends on the embedment depth h_{ef} and the design bond resistance. The simplified formula given in this table is on the safe side.
- c) This is the maximum recommended torque moment to avoid splitting failure during installation for anchors with minimum spacing and/or edge distance.

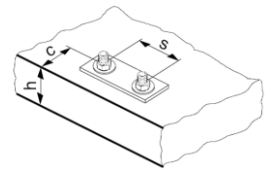

Installation equipment

Anchor size	M8	M10	M12	M16	M20	M24	M27	M30
Rotary hammer	TE 2 – TE 16				TE 40 – TE 80			
Other tools	Compressed air gun or blow out pump Set of cleaning brushes, dispenser, piston plug							

Drilling and cleaning parameters

HIT-V HAS	Drill bit diameters d_0 [mm]		Installation size [mm]	
	Hammer drill (HD)	Hollow Drill Bit (HDB)	Brush HIT-RB	Piston plug HIT-SZ
M8	10	-	10	-
M10	12	12	12	12
M12	14	14	14	14
M16	18	18	18	18
M20	22	22	22	22
M24	28	28	28	28
M27	30	-	30	30
M30	35	35	35	35

Setting instructions

*For detailed information on installation see instruction for use given with the package of the product.



Safety regulations.

Review the Material Safety Data Sheet (MSDS) before use for proper and safe handling! Wear well-fitting protective goggles and protective gloves when working with Hilti HIT-RE 100.

Drilling

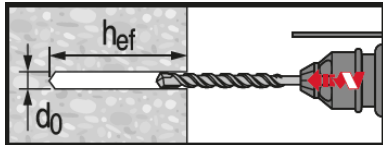

Hammer drilled hole

For dry and wet concrete.

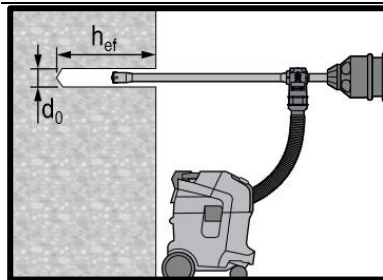

Hammer drilled hole with Hollow Drilled Bit (HDB)

No cleaning required.

Cleaning

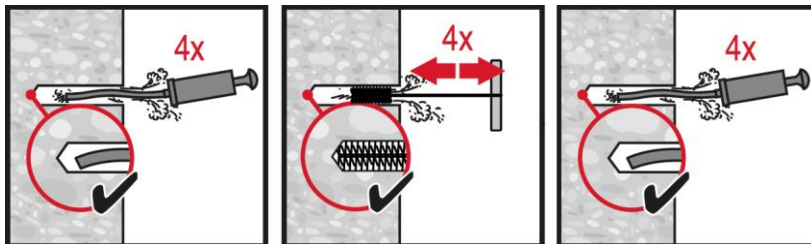

Manual cleaning (MC) Non-cracked concrete only

for drill diameters $d_0 \leq 20$ mm and drill hole depths $h_0 \leq 10 \cdot d$.

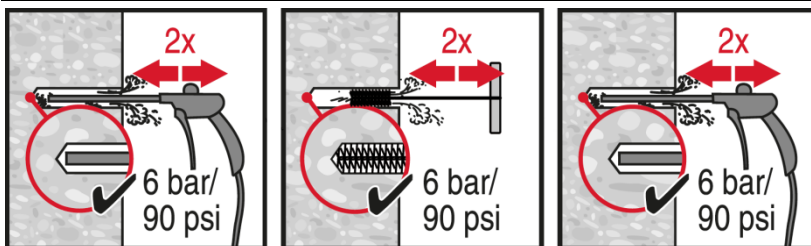

Compressed air cleaning (CAC)

for all drill hole diameters d_0 and drill hole depths $h_0 \leq 20 \cdot d$.

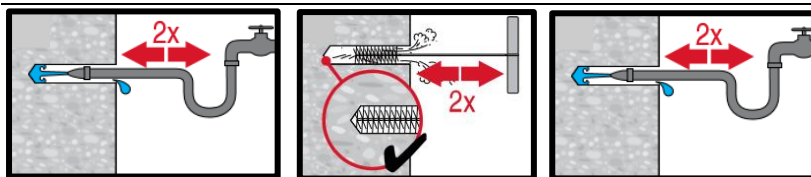

Compressed air cleaning (CAC) cleaning of flooded holes

for all drill hole diameters d_0 and drill hole depths h_0 .

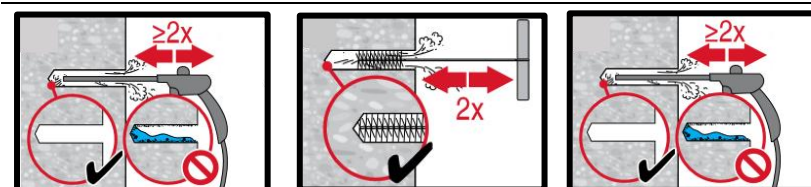

Injection system

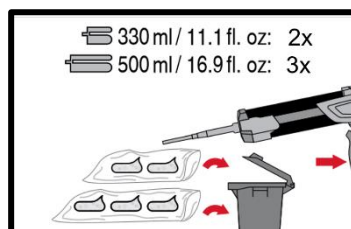
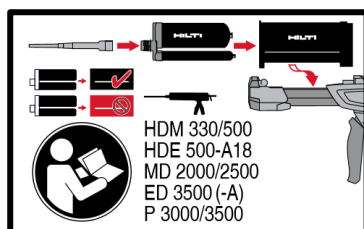

Injection system preparation.

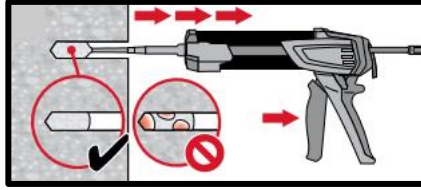
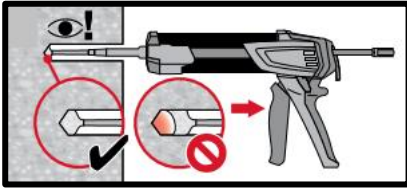

Injection method for drill hole depth $h_{ef} \leq 250$ mm.

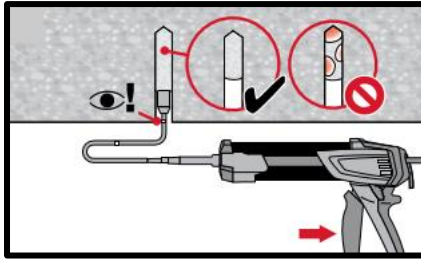
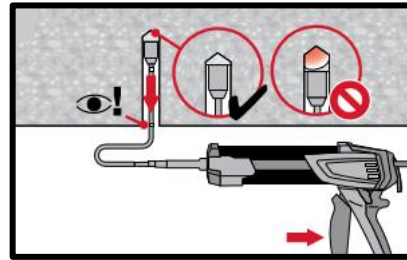

Injection method for overhead application and/or installation with embedment depth $h_{ef} > 250$ mm.

Setting the element

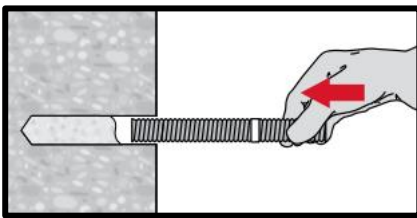

Setting element, observe working time " t_{work} ",

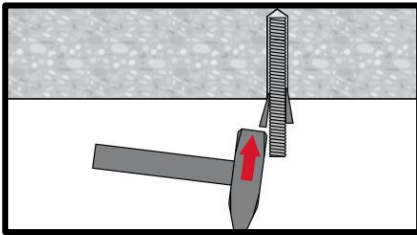

Setting element for overhead applications, observe working time " t_{work} ",

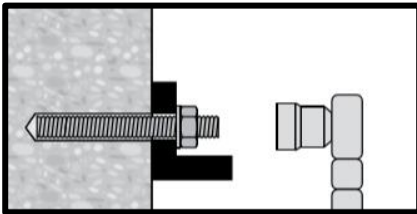

Loading the anchor: After required curing time t_{cure} the anchor can be loaded.



Concrete

Chemical anchors

Mechanical anchors

Plastic/Light duty metal anchors

Insulation anchors

HIT-RE 100 injection mortar

Anchor design (ETAG 001) / Rebar elements / Concrete

Concrete

Chemical anchors

Mechanical anchors

Plastic/Light duty metal anchors

Insulation anchors

Injection mortar system



Hilti HIT-RE 100
330 ml foil pack
(also available as
500 ml and 1400
ml foil pack)

Rebar B500B
($\phi 8$ - $\phi 32$)

Benefits

- Suitable for cracked and non-cracked concrete C 20/25 to C 50/60
- High loading capacity
- Suitable for dry and water saturated concrete
- Large diameter applications
- Long working time at elevated temperatures
- Odourless epoxy

Base material



Concrete (non-cracked)

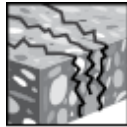

Concrete (cracked)

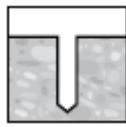

Dry concrete

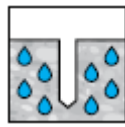

Wet concrete

Load conditions

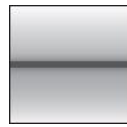

Static/
quasi-static

Installation conditions

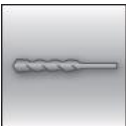

Hammer
drilling

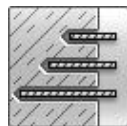

Variable
embedment
depth

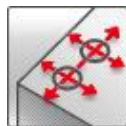

Small edge
distance and
spacing

Other informations



European
Technical
Assessment



CE
conformity

Approvals / certificates

Description	Authority / Laboratory	No. / date of issue
European technical assessment ^{a)}	CSTB, Marne la Vallée	ETA-15/0882 / 2017-12-11

b) All data given in this section according to ETA-15/0882 issue 2017-12-11.

Static and quasi-static loading (for a single anchor)

All data in this section applies to

- Correct setting (See setting instruction)
- No edge distance and spacing influence
- Steel failure
- Base material thickness, as specified in the table
- One typical embedment depth, as specified in the table
- One anchor material, as specified in the tables
- Concrete C 20/25, $f_{ck,cube} = 25 \text{ N/mm}^2$
- Temperature range I
(min. base material temperature -40°C , max. long term/short term base material temperature: $+24^\circ\text{C}/40^\circ\text{C}$)

Embedment depth and base material thickness for static and quasi-static loading data

Anchor- size	$\phi 8$	$\phi 10$	$\phi 12$	$\phi 14$	$\phi 16$	$\phi 20$	$\phi 25$	$\phi 26$	$\phi 28$	$\phi 30$	$\phi 32$
Typical embedment depth [mm]	80	90	110	125	125	170	210	230	270	285	300
Base material thickness [mm]	110	120	140	161	165	220	274	294	340	359	380

Characteristic resistance

Anchor- size B500 B	$\phi 8$	$\phi 10$	$\phi 12$	$\phi 14$	$\phi 16$	$\phi 20$	$\phi 25$	$\phi 26$	$\phi 28$	$\phi 30$	$\phi 32$
Non-cracked concrete											
Tensile N_{Rk}	28,0	39,6	58,1	66,0	70,6	111,9	153,7	176,2	224,0	243,0	262,4
Shear V_{Rk}	14,0	22,0	31,0	42,0	55,0	86,0	135,0	146,0	169,0	194,0	221,0
Cracked concrete											
Tensile N_{Rk}	-	19,8	29,0	35,7	40,8	64,1	99,0	103,3	130,6	147,7	165,9
Shear V_{Rk}	-	22,0	31,0	42,0	55,0	86,0	135,0	146,0	169,0	194,0	221,0

Design resistance

Anchor- size B500 B	$\phi 8$	$\phi 10$	$\phi 12$	$\phi 14$	$\phi 16$	$\phi 20$	$\phi 25$	$\phi 26$	$\phi 28$	$\phi 30$	$\phi 32$
Non-cracked concrete											
Tensile N_{Rd}	13,4	18,8	27,6	31,4	33,6	53,3	73,2	83,9	106,7	115,7	125,0
Shear V_{Rd}	11,2	14,7	20,7	28,0	36,7	57,3	90,0	97,3	129,3	129,3	147,3
Cracked concrete											
Tensile N_{Rd}	-	9,4	13,8	17,0	19,4	30,5	47,1	49,2	62,2	70,3	79,0
Shear V_{Rd}	-	14,7	20,7	28,0	36,7	57,3	90,0	97,3	129,3	129,3	147,3

Recommended loads ^{a)}

Anchor- size B500 B	$\phi 8$	$\phi 10$	$\phi 12$	$\phi 14$	$\phi 16$	$\phi 20$	$\phi 25$	$\phi 26$	$\phi 28$	$\phi 30$	$\phi 32$
Non-cracked concrete											
Tensile N_{Rd}	9,6	13,5	19,7	22,4	24,0	38,1	52,3	59,9	76,2	82,6	89,3
Shear V_{Rd}	8,0	10,5	14,8	20,0	26,2	41,0	64,3	69,5	80,5	92,4	105,2
Cracked concrete											
Tensile N_{Rd}	-	6,7	9,9	12,2	13,9	21,8	33,7	35,1	44,4	50,2	56,4
Shear V_{Rd}	-	10,5	14,8	20,0	26,2	41,0	64,3	69,5	80,5	92,4	105,2

a) With overall partial safety factor for action $\gamma=1,4$, The partial safety factors for action depend on the type of loading and shall be taken from national regulations,

Materials

Mechanical properties

Anchor size	φ8	φ10	φ12	φ14	φ16	φ20	φ25	φ26	φ28	φ30	φ32
Nominal tensile strength f_{uk} [N/mm ²]	550	550	550	550	550	550	550	550	550	550	550
Yield strength f_{yk} [N/mm ²]	500	500	500	500	500	500	500	500	500	500	500
Stressed cross-section A_s [mm ²]	50,3	78,5	113,1	153,9	201,1	314,2	490,9	531	615,8	707	804,2
Moment of resistance W [mm ³]	50,3	98,2	169,6	269,4	402,1	785,4	1534	1726	2155	2651	3217

Material quality

Part	Material
Rebar EN 1992-1-1:2004	Bars and de-coiled rods class B or C II according to NDP or NCL of EN 1992-1-1/NA:2013

Setting information

Installation temperature

+ 5°C to + 40°C

Service temperature range

Hilti HIT-RE 100 injection mortar may be applied in the temperature ranges given below, An elevated base material temperature may lead to a reduction of the design bond resistance,

Temperature range	Base material temperature	Max, long term base material temperature	Max, short term base material temperature
Temperature range I	-40 °C to + 40 °C	+ 24 °C	+ 40 °C
Temperature range II	-40 °C to + 58 °C	+ 35 °C	+ 58 °C
Temperature range III	-40 °C to + 70 °C	+ 43 °C	+ 70 °C

Max, short term base material temperature

Short term elevated base material temperatures are those that occur over brief intervals, e.g, as a result of diurnal cycling,

Max, long term base material temperature

Long term elevated base material temperatures are roughly constant over significant periods of time,

Working time and curing time

Temperature of the base material	Max, working time in which rebar can be inserted and adjusted t_{work}	Min, curing time before rebar can be fully loaded t_{cure}
5 °C ≤ T_{BM} < 10 °C	2 h	72 h
10 °C ≤ T_{BM} < 15 °C	1,5 h	48 h
15 °C ≤ T_{BM} < 20 °C	30 min	24 h
20 °C ≤ T_{BM} < 30 °C	20 min	12 h
30 °C ≤ T_{BM} < 40 °C	12 min	8 h
40 °C	12 min	4 h

The curing time data are valid for dry base material only, In wet base material the curing times must be doubled,

Setting details

Anchor size		Ø8	Ø10	Ø12		Ø14	Ø16	Ø20	Ø25	Ø26	Ø28	Ø30	Ø32
Nominal diameter of drill bit	d_0 [mm]	10 / 12 ^{a)}	12 / 14 ^{a)}	14 ^{a)}	16 ^{a)}	18	20	24 / 25 ^{a)}	30 / 32 ^{a)}	32	35	37	40
Effective anchorage and drill hole depth range ^{b)}	$h_{ef,mi}$ [mm]	60	60	70	70	75	80	90	100	104	112	120	128
	$h_{ef,ma}$ [mm]	160	200	240	240	280	320	400	500	520	560	600	640
Minimum base material thickness	h_{min} [mm]	$h_{ef} + 30 \text{ mm}$ $\geq 100 \text{ mm}$				$h_{ef} + 2 d_0$							
Minimum spacing	s_{min} [mm]	40	50	60	60	70	80	100	125	130	140	150	160
Minimum edge	c_{min} [mm]	40	50	60	60	70	80	100	125	130	140	150	160
Critical spacing for splitting failure	$s_{cr,sp}$ [mm]	$2 C_{cr,sp}$											
Critical edge distance for splitting failure ^{c)}	$c_{cr,sp}$ [mm]	$1,0 \cdot h_{ef}$				for $h / h_{ef} \geq 2,0$							
		$4,6 h_{ef} - 1,8 h$				for $2,0 > h / h_{ef} > 1,3$							
		$2,26 h_{ef}$				for $h / h_{ef} \leq 1,3$							
Critical spacing for concrete cone failure	$s_{cr,N}$ [mm]	$2 C_{cr,N}$											
Critical edge distance for concrete cone failure ^{d)}	$c_{cr,N}$ [mm]	$1,5 h_{ef}$											

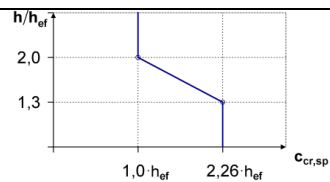

For spacing (edge distance) smaller than critical spacing (critical edge distance) the design loads have to be reduced,

a) Both given values for drill bit diameter can be used

b) $h_{ef,min} \leq h_{ef} \leq h_{ef,max}$ (h_{ef} : embedment depth)

c) h : base material thickness ($h \geq h_{min}$)

d) The critical edge distance for concrete cone failure depends on the embedment depth h_{ef} and the design bond resistance, The simplified formula given in this table is on the save side,

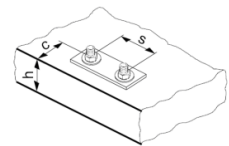

Installation equipment

Anchor size	Ø8	Ø10	Ø12	Ø14	Ø16	Ø20	Ø25	Ø26	Ø28	Ø30	Ø32
Rotary hammer	TE 2– TE 16					TE 40 – TE 80					
Other tools	Compressed air gun or blow out pump Set of cleaning brushes, dispenser, piston plug										

Drilling and cleaning parameters

Rebar [mm]	Drill bit diameters d_0 [mm]		Installation size [mm]	
	Hammer drill (HD)	Hollow Drill Bit (HDB)	Brush HIT-RB	Piston plug HIT-SZ
Ø8	10 / 12 ^{a)}	12 ^{a)}	10 / 12 ^{a)}	- / 12 ^{a)}
Ø10	12 / 14 ^{a)}	12 / 14 ^{a)}	12 / 14 ^{a)}	12 / 14 ^{a)}
Ø12	14 / 16 ^{a)}	14 / 16 ^{a)}	14 / 16 ^{a)}	14 / 16 ^{a)}
Ø14	18	18	18	18
Ø16	20	20	20	20
Ø20	24 / 25 ^{a)}	24 / 25 ^{a)}	24 / 25 ^{a)}	24 / 25 ^{a)}
Ø25	30 / 32 ^{a)}	32 ^{a)}	30 / 32 ^{a)}	30 / 32 ^{a)}
Ø26	32	32	32	32
Ø28	35	-	35	35
Ø30	37	-	37	37
Ø32	40	-	40	40

a) Both of the two given values can be used

Setting instructions

*For detailed information on installation see instruction for use given with the package of the product,



Safety regulations,

Review the Material Safety Data Sheet (MSDS) before use for proper and safe handling! Wear well-fitting protective goggles and protective gloves when working with Hilti HIT-RE 100,

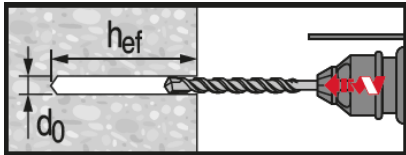

Hammer drilled hole

For dry and wet concrete,

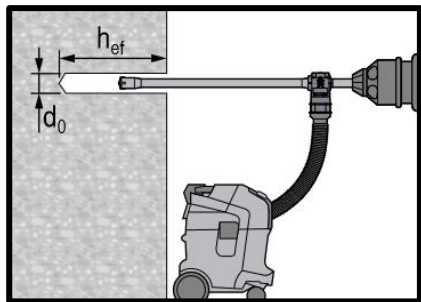

Hammer drilled hole with Hollow Drilled Bit (HDB)

No cleaning required,

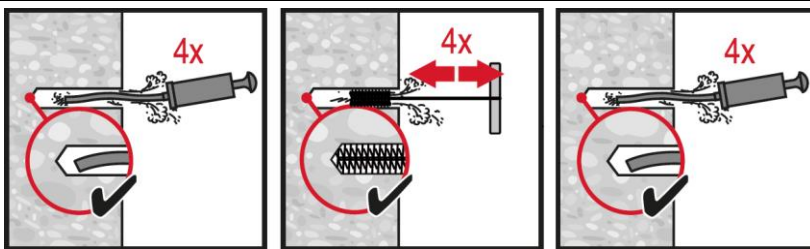

Manual cleaning (MC) Non-cracked concrete only

for drill diameters $d_0 \leq 20$ mm and drill hole depth $h_0 \leq 10 \cdot d_0$,

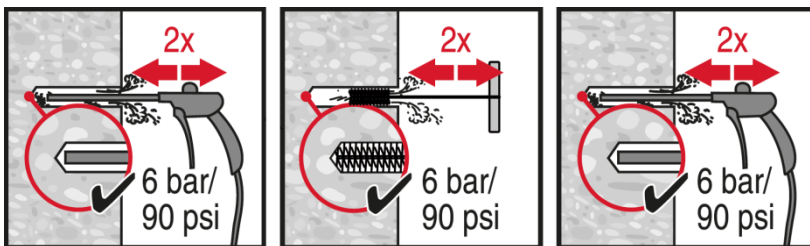

Hammer Drilling: Compressed air cleaning (CAC)

for all drill hole diameters d_0 and drill hole depths $h_0 \leq 20 \cdot d_0$,

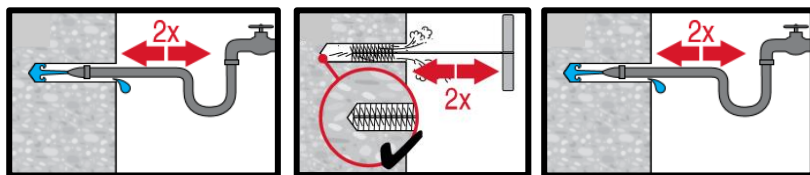

Compressed air cleaning (CAC) cleaning of flooded holes

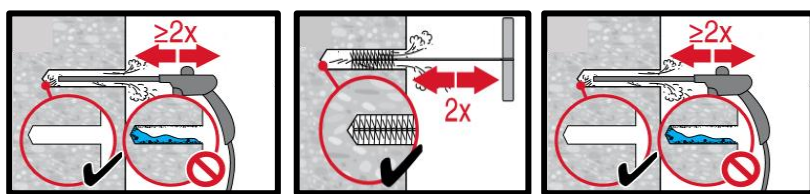

for all drill hole diameters d_0 and drill hole depths h_0 ,

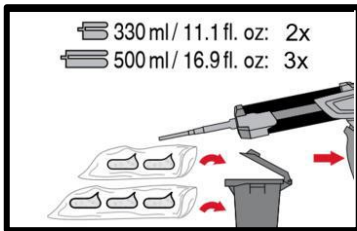
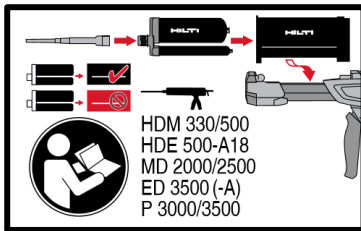

Injection system preparation,

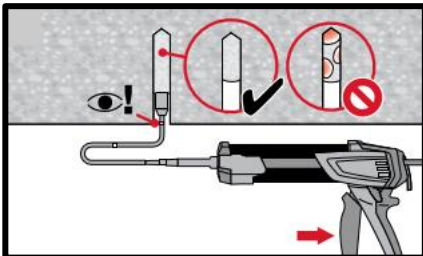
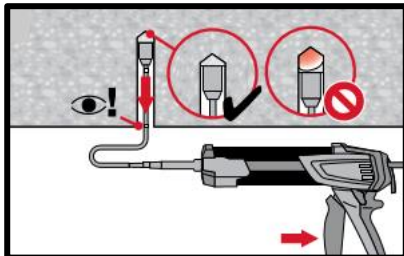

Injection method for overhead application and/or installation with embedment depth $h_{ef} \leq 250$ mm

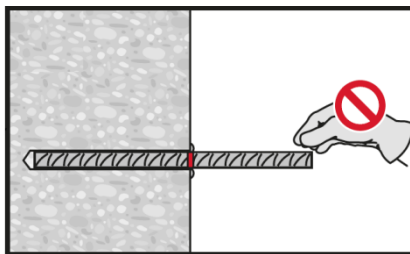
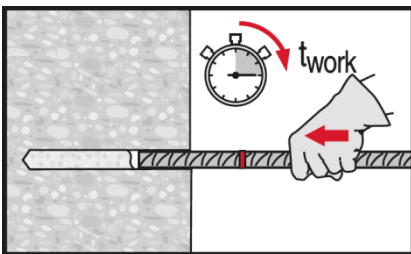

Setting element, observe working time "t_{work}",

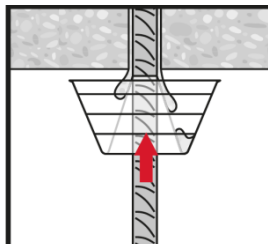
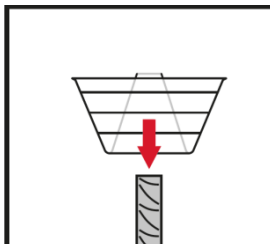
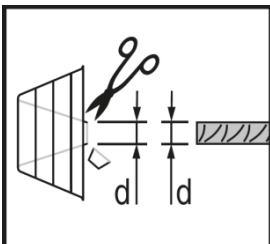

Setting element for overhead applications, observe working time "t_{work}",

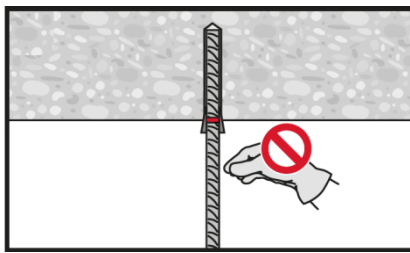
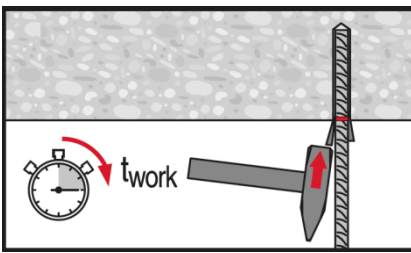

HIT-RE 100 injection mortar

Rebar design (EN 1992-1) / Rebar elements / Concrete

Injection mortar system



Hilti HIT-RE 100
330 ml foil pack
(also available as
500 ml and 1400
ml foil pack)



Rebar B500 B
($\phi 8 - \phi 40$)

Benefits

- Suitable for concrete C 12/15 to C 50/60
- High loading capacity
- Suitable for dry and water saturated concrete
- For rebar diameters up to 40 mm
- Non corrosive to rebar elements
- Long working time at elevated temperatures
- Suitable for embedment length till 3200 mm

Base material



Concrete (non-cracked)

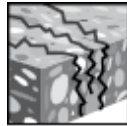

Concrete (cracked)



Dry concrete

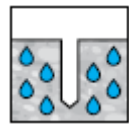

Wet concrete

Load conditions

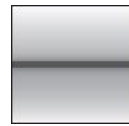

Static/
quasi-static



Fire
resistance

Installation conditions

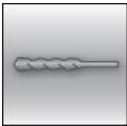

Hammer
drilling



Diamond
coring

Other information



European
Technical
Assessment



CE
conformity

Approvals / certificates

Description	Authority / Laboratory	No, / date of issue
European technical assessment ^{a)}	DIBt, Berlin	ETA – 15/0883 / 2017-12-06
Fire report	MFPA, Leipzig	GS 3,2/15-431-4 / 2016-04-29

c) All data given in this section according to the approvals mentioned above ETA-15/0883 issue 2017-12-06,

Basic design data

Static EC2 design

Design bond strength in N/mm² according to ETA 15/0883 for good bond conditions

Rebar-size	Concrete class								
	C12/15	C16/20	C20/25	C25/30	C30/37	C35/45	C40/50	C45/55	C50/60
All allowed hammer drilling methods									
φ8 - φ32	1,6	2,0	2,3	2,7	3,0	3,4	3,7	4,0	4,3
φ34	1,6	2,0	2,3	2,6	2,9	3,3	3,6	3,9	4,2
φ36	1,5	1,9	2,2	2,6	2,9	3,3	3,6	3,8	4,1
φ40	1,5	1,8	2,1	2,5	2,8	3,1	3,4	3,7	4,0
Diamond coring wet									
φ8 - φ32	1,6	2,0	2,3	2,7					
φ34	1,6	2,0	2,3	2,6					
φ36	1,5	1,9	2,2	2,6					
φ40	1,5	1,8	2,1	2,5					

For poor bond conditions multiply the values by 0,7, Values valid for non-cracked and cracked concrete

Minimum anchorage length and minimum lap length

The minimum anchorage length $\ell_{b,min}$ and the minimum overlap length $\ell_{0,min}$ according to EN 1992-1-1 shall be multiplied by the relevant **Amplification factor** in the table below,

Amplification factor α_{lb} for the min, anchorage length and min, lap length according to EN 1992-1-1 for:

Rebar - size	Concrete class								
	C12/15	C16/20	C20/25	C25/30	C30/37	C35/45	C40/50	C45/55	C50/60
All allowed hammer drilling methods									
φ8 - φ40	1,0								
Diamond coring dry and wet									
φ8 - φ40	1,5								

Pre-calculated values¹⁾ – anchorage length

Rebar yield strength $f_{yk}=500$ N/mm², concrete C25/30, good bond conditions

Rebar-size	Anchorage length	Design value	Mortar volume ²⁾	Anchorage length	Design value	Mortar volume ²⁾	
	ℓ_{bd} [mm]	N_{Rd} [KN]	V_M [ml]		ℓ_{bd} [mm]	N_{Rd} [KN]	V_M [ml]
$\alpha_1=\alpha_2=\alpha_3=\alpha_4=\alpha_5=1,0$							
φ8	100	6,8	8	100	9,7	8	
	170	11,5	13		140	13,6	11
	250	17,0	19		180	17,4	14
	322,1	21,9	24		225,4	21,9	17
φ10	121	10,3	11	121	14,7	11	
	220	18,7	20	170	20,6	15	
	310	26,3	28	230	27,9	21	
	402,6	34,1	36	281,8	34,1	25	
φ12	145	14,8	15	145	21,1	15	
	260	26,5	27	210	30,5	22	
	370	37,7	39	270	39,3	29	
	483,1	49,2	51	338,2	49,2	36	
φ14	169	20,1	20	169	28,7	20	
	300	35,6	36	240	40,7	29	
	430	51,1	52	320	54,3	39	
	563,6	66,9	68	394,5	66,9	48	

Pre-calculated values¹⁾ – anchorage length

Rebar yield strength $f_{yk}=500 \text{ N/mm}^2$, concrete C25/30, good bond conditions

Rebar-size	Anchorage length	Design value	Mortar volume ²⁾	Anchorage length	Design value	Mortar volume ²⁾
	l_{bd} [mm]	N_{Rd} [KN]	V_M [ml]		l_{bd} [mm]	N_{Rd} [KN]
	$\alpha_1=\alpha_2=\alpha_3=\alpha_4=\alpha_5=1,0$			$\alpha_1=\alpha_3=\alpha_4=1,0 \quad \alpha_2 \text{ or } \alpha_5=0,7$		
φ16	193	26,2	26	193	37,4	26
	340	46,1	46	280	54,3	38
	490	66,5	67	370	71,7	50
	644	87,4	87	450,9	87,4	61
φ18	217	33,1	33	217	47,3	33
	380	58	57	310	67,6	47
	540	82,4	81	410	89,4	62
	724,6	110,6	109	507,2	110,6	76
φ20	242	41,1	51	242	58,6	51
	390	66,2	83	350	84,8	74
	550	93,3	117	460	111,5	98
	805,2	136,6	171	563,6	136,6	120
φ22	266	49,6	75	266	70,9	75
	410	76,5	116	380	101,3	107
	560	104,5	158	500	133,3	141
	885,7	165,3	250	620	165,3	175
φ24	290	59	122	290	84,3	122
	430	87,5	182	420	122,1	177
	560	114	236	550	160	232
	966,2	196,7	408	676,3	196,7	286
φ25	302	64	114	302	91,5	114
	430	91,2	162	430	130,3	162
	570	120,9	214	570	172,7	214
	1006,4	213,4	378	704,5	213,4	265
φ28	350	83,1	145	338	114,7	140
	595	141,3	247	480	162,9	200
	875	207,8	364	635	215,5	264
	1127,2	267,7	469	789	267,7	328
φ30	374	95,2	165	374	136	165
	635	161,6	281	528	191,9	233
	935	237,9	413	700	254,5	309
	1207,7	307,3	534	845,4	307,3	374
φ32	400	108,6	217	400	155,1	217
	680	184,6	369	580	224,9	315
	1000	271,4	543	800	310,2	434
	1288,2	349,7	699	901,8	349,7	490
φ36	450	132,3	387	440	184,8	379
	765	225	658	640	268,8	551
	1125	330,8	968	900	378,1	774
	1505,0	442,6	1295	1053,5	442,6	907
φ40	500	157,1	520	485	217,7	505
	850	267	884	700	314,2	728
	1000	314,2	1040	990	444,3	1030
	1739,1	546,4	1810	1217,4	546,4	1267

1) Values corresponding to the minimum anchorage length, The maximum permissible load is valid for "good bond conditions" as described in EN 1992-1-1, For all other conditions multiply by the value by 0,7,

2) The volume of mortar corresponds to the formula " $1,2 \cdot (d_o^2 - d_s^2) \cdot \pi \cdot l_b / 4$ " for hammer drilling

Pre-calculated values – overlap length

Rebar yield strength $f_{yk}=500 \text{ N/mm}^2$, concrete c25/30, good bond conditions

Rebar-size	Overlap length	Design value	Mortar volume ²⁾	Overlap length	Design value	Mortar volume ²⁾
	l_0 [mm]	N_{Rd} [KN]	V_M [ml]		l_0 [mm]	N_{Rd} [KN]
$\alpha_1=\alpha_2=\alpha_3=\alpha_4=\alpha_5=1,0$				$\alpha_1=\alpha_3=\alpha_4=1,0 \quad \alpha_2 \text{ or } \alpha_5=0,7$		
φ8	200	13,6	15	200	19,4	15
	240	16,3	18	210	20,4	16
	280	19	21	220	21,3	17
	322,1	21,9	24	225,4	21,9	17
φ10	200	17	18	200	24,2	18
	270	22,9	24	230	27,9	21
	340	28,8	31	250	30,3	23
	402,6	34,1	36	281,8	34,1	25
φ12	200	20,4	21	200	29,1	21
	290	29,5	31	250	36,4	26
	390	39,7	41	290	42,2	31
	483,1	49,2	51	338,2	49,2	36
φ14	210	24,9	25	210	35,6	25
	330	39,2	40	270	45,8	33
	450	53,4	54	330	56	40
	563,6	66,9	68	394,5	66,9	48
φ16	240	32,6	33	240	46,5	33
	370	50,2	50	310	60,1	42
	510	69,2	69	380	73,7	52
	644	87,4	87	450,9	87,4	61
φ18	270	41,2	41	270	58,9	41
	410	62,6	62	350	76,3	53
	560	85,5	84	430	93,8	65
	724,6	110,6	109	507,2	110,6	76
φ20	300	50,9	64	300	72,7	64
	430	72,9	91	390	94,5	83
	570	96,7	121	480	116,3	102
	805,2	136,6	171	563,6	136,6	120
φ22	330	61,6	93	330	88	93
	450	84	127	430	114,6	122
	580	108,2	164	520	138,6	147
	885,7	165,3	250	620	165,3	175
φ24	360	73,3	152	360	104,7	152
	470	95,7	198	470	136,7	198
	590	120,1	249	570	165,8	241
	966,2	196,7	408	676,3	196,7	286
φ25	375	79,5	141	375	113,6	141
	430	91,2	162	480	145,4	181
	570	120,9	214	590	178,7	222
	1006,4	213,4	378	704,5	213,4	265
φ28	420	99,8	175	420	142,5	175
	595	141,3	247	530	179,8	220
	875	207,8	364	635	215,5	264
	1127,2	267,7	469	789	267,7	328

Concrete

Chemical anchors

Mechanical anchors

Plastic/Light duty metal anchors

Insulation anchors

Pre-calculated values – overlap length

Rebar yield strength $f_{yk}=500 \text{ N/mm}^2$, concrete c25/30, good bond conditions

Rebar-size	Overlap length	Design value	Mortar volume ²⁾	Overlap length	Design value	Mortar volume ²⁾
	l_0 [mm]	N_{Rd} [KN]	V_M [ml]		l_0 [mm]	N_{Rd} [KN]
	$\alpha_1=\alpha_2=\alpha_3=\alpha_4=\alpha_5=1,0$			$\alpha_1=\alpha_3=\alpha_4=1,0 \quad \alpha_2 \text{ or } \alpha_5=0,7$		
$\phi 30$	450	114,5	199	450	163,6	199
	635	161,6	281	528	191,9	233
	935	237,9	413	700	254,5	309
	1207,7	307,3	534	845,4	307,3	374
$\phi 32$	480	130,3	261	480	186,1	261
	680	184,6	369	650	252	353
	1000	271,4	543	800	310,2	434
	1288,2	349,7	699	901,8	349,7	490
$\phi 36$	540	158,8	465	540	218,1	465
	765	225,0	658	720	290,0	620
	1125	330,8	968	900	363,5	774
	1505,0	442,6	1295	1053,5	442,6	907
$\phi 40$	600	188,5	624	600	269,3	624
	850	267,0	884	750	336,6	780
	1000	314,2	1040	990	444,3	1030
	1739,1	505,9	1676	1217,4	546,4	1267

- 1) Values corresponding to the minimum anchorage length, The maximum permissible load is valid for "good bond conditions" as described in EN 1992-1-1, For all other conditions multiply by the value by 0,7,
- 2) The volume of mortar corresponds to the formula " $1,2 \cdot (d_0^2 - d_s^2) \cdot \pi \cdot l_b / 4$ " for hammer drilling

Fire resistance

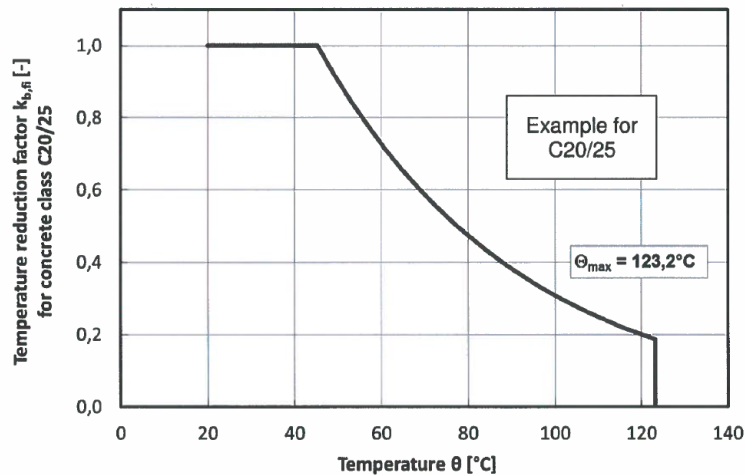

The design value of the bond strength $f_{bd,fi}$ under fire exposure has to be calculated by the following equation:

$$f_{bd,fi} = k_{b,fi}(\theta) \cdot f_{bd} \cdot \gamma_c / \gamma_{M,fi}$$

With: $\theta \leq 123,2^\circ\text{C}$: $k_{b,fi}(\theta) = 26,424 \cdot e^{-0,0215 \cdot \theta} / f_{bd} \cdot 4,3 \leq 1,0$
 $\theta > 123,2^\circ\text{C}$: $k_{b,fi}(\theta) = 0,0$

$f_{bd,fi}$ design value of the ultimate bond stress in case of fire in N/mm^2
 θ temperature in $^\circ\text{C}$ in the mortar layer
 $k_{b,fi}(\theta)$ reduction factor under fire exposure
 f_{bd} design values of the ultimate bond stress in N/mm^2 in cold condition
 γ_c partially safety factor according to EN 1992-1-1
 $\gamma_{M,fi}$ partially safety factor according to EN 1992-1-2

a) Anchoring application

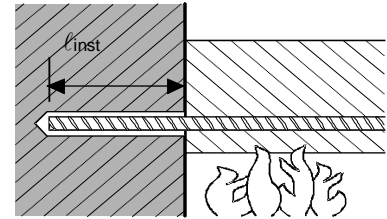

Anchoring application beam-wall connections with a concrete cover of 20 mm

Maximum force ($F_{s,T,max}$) in rebar in conjunction with HIT-RE 100 as a function of embedment depth (l_{inst}) for the fire resistance classes F30 to F240 according to EC2,

Rebar-size	$F_{s,T,max}$ [kN]	l_{inst} [mm]	Fire resistance of bar [kN]						
			R30	R60	R90	R120	R180	R240	
$\phi 8$	16,8	100	3,4	1,0	0,2	-	-	-	
		110	4,3	1,7	0,5	-	-	-	
		140	6,9	4,2	2,2	0,9	-	-	
		160	8,6	6,0	3,9	2,1	0,5	-	
		260	16,8	16,8	14,6	12,5	10,7	7,7	5,3
		290			15,1	13,3	10,3	7,9	
		310			16,8	15,1	12,1	9,6	
		330				13,8	11,4		
		370				16,8	14,8		
		400				16,8	16,8		
$\phi 10$	26,2	110	5,3	2,1	0,6	-	-	-	
		140	8,6	5,3	2,7	1,2	-	-	
		160	10,8	7,4	4,8	2,7	0,6	-	
		260	21,6	18,3	15,7	13,4	9,7	6,6	
		290	24,8	21,5	18,9	16,7	12,9	9,9	
		310	26,2	26,2	23,7	21,1	18,8	15,1	12,0
		340			24,3	22,1	18,3	15,3	
		360			26,2	24,2	20,5	17,5	
		380			26,2	26,2	22,7	19,6	
		450			26,2	26,2	26,2	26,2	
26,2	26,2								
$\phi 12$	37,7	130	9,0	5,0	2,2	0,8	-	-	
		140	10,3	6,3	3,2	1,4	-	-	
		160	12,9	8,9	5,8	3,2	0,8	-	
		260	25,9	21,9	18,8	16,1	11,6	7,9	
		360	37,7	37,7	35,0	31,8	29,1	24,6	20,9
		390			35,7	33,0	28,5	24,8	
		450			37,7	37,7	36,3	32,6	
		500			37,7	37,7	37,7	37,7	
$\phi 14$	51,3	160	15,1	10,4	6,8	3,7	0,9	-	
		260	30,2	25,6	21,9	18,8	13,5	9,3	
		360	45,4	40,8	37,1	33,9	28,7	24,4	
		400	51,3	51,3	46,8	43,2	40,0	34,8	30,5
		450			50,8	47,6	42,4	38,1	
		500			51,3	51,3	50,0	45,7	
		550			51,3	51,3	51,3	51,3	

Maximum force ($F_{s,T,max}$) in rebar in conjunction with HIT-RE 100 as a function of embedment depth (ℓ_{inst}) for the fire resistance classes F30 to F240 according to EC2,

Rebar-size	$F_{s,T,max}$ [kN]	ℓ_{inst} [mm]	Fire resistance of bar [kN]					
			R30	R60	R90	R120	R180	R240
$\phi 16$	67,0	180	20,7	15,4	11,2	7,6	2,7	0,9
		260	34,5	29,3	25,1	21,5	15,5	10,6
		360	51,9	46,6	42,4	38,8	32,8	27,9
		450	67,0	62,2	58,0	54,4	48,4	43,5
		500						
		550	67,0	66,7	63,1	57,1	52,2	
		600	67,0	67,0	67,0	65,8	60,9	
600	67,0	67,0	67,0	67,0	67,0			
$\phi 18$	84,8	200	27,2	21,2	16,5	12,4	5,9	2,6
		260	38,9	32,9	28,2	24,1	17,4	11,9
		360	58,4	52,4	47,7	43,6	36,9	31,4
		500	84,8	79,7	75,0	71,0	64,2	58,7
		550						
		600	84,8	84,8	84,8	80,7	74,0	68,5
		650	84,8	84,8	84,8	84,8	83,8	78,2
650	84,8	84,8	84,8	84,8	84,8	84,8		
$\phi 20$	104,7	220	34,5	27,9	22,7	18,2	10,7	5,5
		260	43,2	36,6	31,3	26,8	19,4	13,2
		360	64,9	58,3	53,0	48,5	41,0	34,9
		550	104,7	99,4	94,2	89,7	82,2	76,1
		600						
		650	104,7	104,7	104,7	100,5	93,1	86,9
		700	104,7	104,7	104,7	104,7	103,9	97,8
700	104,7	104,7	104,7	104,7	104,7	104,7		
$\phi 22$	126,7	240	42,7	35,5	29,7	24,7	16,5	9,9
		360	71,3	64,1	58,3	53,3	45,1	38,4
		500	104,7	97,5	91,7	86,7	78,5	71,8
		600	126,7	121,3	115,5	110,6	102,4	95,6
		650						
		700	126,7	126,7	126,7	122,5	114,3	107,5
		750	126,7	126,7	126,7	126,7	126,2	119,5
750	126,7	126,7	126,7	126,7	126,7	126,7		
$\phi 24$	150,8	270	54,4	46,5	40,2	34,8	25,8	18,5
		360	77,8	69,9	63,6	58,2	49,2	41,9
		650	150,8	145,3	139,1	133,6	124,7	117,3
		700						
		750	150,8	150,8	150,8	146,6	137,7	130,3
		800	150,8	150,8	150,8	150,8	150,7	143,3
800	150,8	150,8	150,8	150,8	150,8	150,8		
$\phi 25$	163,6	280	59,4	51,1	44,6	38,9	29,6	22,0
		360	81,1	72,8	66,3	60,6	51,3	43,6
		700	163,6	158,4	152,8	143,4	135,8	129,0
		750						
		800	163,6	163,6	163,6	163,6	157,0	149,3
		850	163,6	163,6	163,6	163,6	163,6	162,9
850	163,6	163,6	163,6	163,6	163,6	163,6		
$\phi 26$	177,0	290	64,6	56,0	49,2	43,3	33,6	25,6
		360	84,3	75,7	68,9	63,0	53,3	45,4
		700	177,0	171,5	164,7	158,9	149,2	141,2
		750						
		800	177,0	177,0	177,0	173,0	163,2	155,3
		850	177,0	177,0	177,0	177,0	177,0	169,4
850	177,0	177,0	177,0	177,0	177,0	177,0		
$\phi 27$	190,9	300	70,0	61,1	54,0	47,9	37,8	29,6
		500	128,5	119,6	112,5	106,4	96,4	88,1
		750	190,9	185,7	179,6	179,6	169,5	161,2
		800						
		850	190,9	190,9	190,9	190,9	184,2	175,9
		900	190,9	190,9	190,9	190,9	190,9	190,5
900	190,9	190,9	190,9	190,9	190,9	190,9		
$\phi 28$	205,3	300	75,6	66,4	59,0	52,7	42,3	33,7
		500	133,3	124,0	116,7	110,4	99,9	91,3
		750	205,3	199,9	192,6	186,3	175,8	167,2
		800						
		850	205,3	205,3	205,3	201,4	191,0	182,4
		900	205,3	205,3	205,3	205,3	205,3	197,6
900	205,3	205,3	205,3	205,3	205,3	205,3		

Maximum force ($F_{s,T,max}$) in rebar in conjunction with HIT-RE 100 as a function of embedment depth (l_{inst}) for the fire resistance classes F30 to F240 according to EC2,

Rebar-size	$F_{s,T,max}$ [kN]	l_{inst} [mm]	Fire resistance of bar [kN]					
			R30	R60	R90	R120	R180	R240
$\phi 30$	235,6	330	87,5	77,6	69,8	63,0	51,8	42,6
		500	142,8	132,9	125,0	118,3	107,1	97,9
		800	235,6	230,4	222,6	215,8	204,6	195,4
		850		235,6	235,6	235,6	232,1	220,9
		900	227,9					
		950	235,6					
$\phi 32$	268,1	350	100,3	89,7	81,4	74,1	62,2	
		500	152,3	141,8	133,4	126,2	114,2	104,4
		850	268,1	263,2	254,8	247,5	235,6	225,8
		900		268,1	268,1	264,9	252,9	243,1
		950	268,1	268,1	268,1	268,1	260,5	
$\phi 34$	302,6	370	113,9	102,7	93,8	86,1	73,4	63,0
		500	161,8	150,6	141,7	134,0	121,3	110,9
		900	302,6	298,0	289,1	281,4	268,8	258,3
		950		302,6	302,6	299,9	287,2	276,8
$\phi 36$	339,3	400	132,3	120,5	111,0	102,9	89,5	78,4
		600	210,4	198,5	189,1	180,9	167,5	156,5
		800	288,4	276,5	267,1	259,0	245,5	234,5
		950	339,3	335,1	325,6	317,5	304,1	293,0
$\phi 40$	385,5	450	168,7	155,5	145,1	136,0	121,1	108,8
		600	233,8	220,6	210,1	201,0	186,1	173,9
		800	320,5	307,3	296,8	287,8	272,8	260,6
		950	385,5	372,3	361,8	352,8	337,9	325,6

*For additional values please check GS 3,2/15-431-4 fire report, Characteristic yield strength $f_{yk} = 500 \text{ N/mm}^2$

Steel failure

b) Overlap joint application

Max, bond stress, $f_{bd,FIRE}$, depending on actual clear concrete cover for classifying the fire resistance,

It must be verified that the actual force in the bar during a fire, $F_{s,T}$, can be taken up by the bar connection of the selected length, l_{inst} , Note: Cold design for ULS is mandatory,

$$F_{s,T} \leq (l_{inst} - c_f) \cdot \phi \cdot \pi \cdot f_{bd,FIRE} \quad \text{where: } (l_{inst} - c_f) \geq l_s;$$

l_s = lap length

ϕ = nominal diameter of bar

$l_{inst} - c_f$ = selected overlap joint length; this must be at least l_s ,

but may not be assumed to be more than 80ϕ

$f_{bd,FIRE}$ = bond stress when exposed to fire

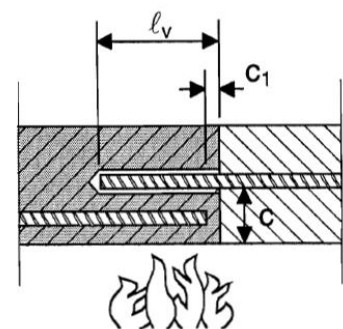

Critical temperature-dependent bond stress, $f_{bd,FIRE}$, concerning "overlap joint" for Hilti HIT-RE 100 injection adhesive in relation to fire resistance class and required minimum concrete coverage c ,

Clear concrete cover c [mm]	Max, bond stress, τ_c [N/mm ²]					
	R30	R60	R90	R120	R180	R240
50	0,9					
60	1,7					
70	2,7					
80	3,5	1,0				
90		1,6				
100		2,3	1,0			
110		3,0	1,4			

Critical temperature-dependent bond stress, $f_{bd, FIRE}$, concerning “overlap joint” for Hilti HIT-RE 100 injection adhesive in relation to fire resistance class and required minimum concrete coverage c ,

Clear concrete cover c [mm]	Max, bond stress, τ_c [N/mm ²]					
	R30	R60	R90	R120	R180	R240
120			1,9	1,0		
130			2,5	1,4		
140			3,1	1,9	0,7	
150			3,5	2,4	1,0	
160				2,9	1,3	
170				3,4	1,7	0,9
180		3,5	3,5	3,5	2,1	1,1
190					2,5	1,4
200					2,9	1,7
210					3,3	2,1
220					3,5	2,5
230						2,8
240						3,1
250						3,5
260						

Materials

Material quality

Part	Material
Rebar EN 1992-1-1:2004+AC:2010	Bars and de-coiled rods class B or C with f_{yk} and k according to NDP or NCL of EN 1992-1-1/NA:2013 $f_{uk} = f_{tk} = k \cdot f_{yk}$

Fitness for use

Some creep tests have been conducted in accordance with ETAG guideline 001 part 5 and TR 023 in the following conditions: **in dry environment at 50 °C during 90 days,**

These tests show an excellent behaviour of the post-installed connection made with HIT-RE 100: low displacements with long term stability, failure load after exposure above reference load,

Resistance to chemical substances

Chemical	Resistance	Chemical	Resistance
Acetic acid 100%	o	Methanol 100%	o
Acetic acid 10%	+	Peroxide of hydrogen 30%	o
Hydrochloric Acid 20%	+	Solution of phenol (sat.)	-
Nitric Acid 40%	-	Sodium hydroxide pH=14	+
Phosphoric Acid 40%	+	Solution of chlorine (sat.)	+
Sulphuric acid 40%	+	Solution of hydrocarbons (60 % vol Toluene, 30 % vol Xylene, 10 % vol Methyl naphthalene)	+
Ethyl acetate 100%	o	Salted solution 10%	+
Acetone 100%	-	sodium chloride	
Ammoniac 5%	o	Suspension of concrete (sat.)	+
Diesel 100%	+	Chloroform 100%	+
Gasoline 100%	+	Xylene 100%	+
Ethanol 96%	o		
Machine oils 100%	+		

- + resistant
 o resistant in short term (max, 48h) contact

- not resistant

Electrical Conductivity

HIT-RE 100 in the hardened state is **not conductive electrically**, Its electric resistivity is $1,4 \cdot 10^{10} \Omega \cdot m$ (DIN IEC 93 – 12,93), It is adapted well to realize electrically insulating anchorings (ex: railway applications, subway),

Installation temperature range:

+5°C to +40°C

Service temperature range

Hilti HIT-RE 100 injection mortar may be applied in the temperature ranges given below, An elevated base material temperature may lead to a reduction of the design bond resistance,

Temperature range	Base material temperature	Maximum long term base material temperature	Maximum short term base material temperature
Temperature range I	-40 °C to +80 °C	+50 °C	+80 °C

Max short term base material temperature

Short-term elevated base material temperatures are those that occur over brief intervals, e.g, as a result of diurnal cycling,

Max long term base material temperature

Long-term elevated base material temperatures are roughly constant over significant periods of time,

Working time and curing time^{a)}

Temperature IN the base material T_{BM}	Maximum working time t_{work}	Initial curing time $t_{cure,ini}^{b)}$	Minimum curing time t_{cure}
$5\text{ °C} \leq T_{BM} < 9\text{ °C}$	2 hours	18 hours	72 hours
$10\text{ °C} \leq T_{BM} < 14\text{ °C}$	1,5 hours	12 hours	48 hours
$15\text{ °C} \leq T_{BM} < 19\text{ °C}$	30 min	8 hours	24 hours
$20\text{ °C} \leq T_{BM} < 24\text{ °C}$	25 min	6 hours	12 hours
$25\text{ °C} \leq T_{BM} < 29\text{ °C}$	20 min	5 hours	10 hours
$30\text{ °C} \leq T_{BM} \leq 39\text{ °C}$	12 min	4 hours	8 hours
40 °C	12 min	2 hours	4 hours

a) The curing time data are valid for dry base material only, In wet base material the curing times must be doubled,

b) After $t_{cure,ini}$ has elapsed preparation work may continue

Setting information

Installation equipment

Rebar – size	$\phi 8\text{-}\phi 16$	$\phi 18\text{-}\phi 40$
Rotary hammer	TE2(-A) – TE30(-A)	TE40 – TE80
Other tools	Blow out pump ($h_{ef} \leq 10 \cdot d$)	-
	Compressed air gun ^{a)} Set of cleaning brushes ^{b)} , dispenser, piston plug	

a) Compressed air gun with extension hose for all drill holes deeper than 250 mm (for $\phi 8$ to $\phi 12$) or deeper than $20 \cdot \phi$ (for $\phi > 12$ mm)

b) Automatic brushing with round brush for all drill holes deeper than 250 mm (for $\phi 8$ to $\phi 12$) or deeper than $20 \cdot \phi$ (for $\phi > 12$ mm)

Minimum concrete cover c_{min} of the post-installed rebar

Drilling method	Rebar – size [mm]	Minimum concrete cover c_{min} [mm]	
		Without drilling aid	With drilling aid
Hammer drilling (HD)	$\phi < 25$	$30 + 0,06 \cdot l_v \geq 2 \cdot \phi$	$30 + 0,02 \cdot l_v \geq 2 \cdot \phi$
	$\phi \geq 25$	$40 + 0,06 \cdot l_v \geq 2 \cdot \phi$	$40 + 0,02 \cdot l_v \geq 2 \cdot \phi$
Compressed air drilling (CA)	$\phi < 25$	$50 + 0,08 \cdot l_v$	$50 + 0,02 \cdot l_v$
	$\phi \geq 25$	$60 + 0,08 \cdot l_v \geq 2 \cdot \phi$	$60 + 0,02 \cdot l_v \geq 2 \cdot \phi$
Diamond coring dry (PCC) or wet (DD)	$\phi < 25$	Drill stand is used as drilling aid	$30 + 0,02 \cdot l_v \geq 2 \cdot \phi$
	$\phi \geq 25$		$40 + 0,02 \cdot l_v \geq 2 \cdot \phi$

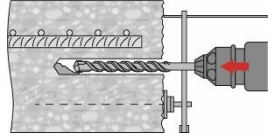
Drilling and cleaning diameters

Rebar [mm]	Drill bit diameters d_0 [mm]			Diamond core d_0 [mm]		Installation size [mm]	
	Hammer drill (HD)	Compressed air drill (CA)	Hollow Drill Bit (HDB)	Wet (DD)	Dry (PCC) ^{b)}	Brush HIT-RB	Air nozzle HIT-RB
$\phi 8$	12 (10 ^{a)})	-	-	12 (10 ^{a)})	-	12 (10 ^{a)})	12 (10 ^{a)})
$\phi 10$	14 (12 ^{a)})	-	-	14 (12 ^{a)})	-	14 (12 ^{a)})	14 (12 ^{a)})
$\phi 12$	16 (14 ^{a)})	-	-	16 (14 ^{a)})	-	16 (14 ^{a)})	16 (14 ^{a)})
	-	17	-	-	-	18	16
$\phi 14$	18	17	-	18	-	18	18
$\phi 16$	20	-	-	20	-	20	20
	-	20	-	-	-	22	20
$\phi 18$	22	22	-	22	-	22	22
$\phi 20$	25 (24 ^{a)})	-	-	25	-	25 (24 ^{a)})	25 (24 ^{a)})
	-	26	-	-	-	28	25
$\phi 22$	28	28	-	28	-	28	28
$\phi 24$	32	32	-	32	-	32	32
	-	-	35	-	35	-	
$\phi 25$	32 (30 ^{a)})	32 (30 ^{a)})	-	32 (30 ^{a)})	-	32 (30 ^{a)})	
	-	-	35	-	35	-	
$\phi 26$	35	35	35	35	35	35	
$\phi 28$	35	35	35	35	35	35	
$\phi 30$	-	35	35	35	35	35	
	37	-	-	-		37	
$\phi 32$	40	40	47	40	47	40	
$\phi 34$	-	42	-	42	47	42	
	45	-	47	-		45	
$\phi 36$	45	45	-	-	47	45	
	-	-	47	47		47	
$\phi 40$	-	-	52	52	52	52	
	55	57	-	-		55	

- a) Both of a given values can be used,
b) No cleaning required,

Dispenser and corresponding maximum embedment depth $l_{v,max}$

Rebar	Dispenser	
	HDM 330, HDM 500	HDE 500
	$l_{v,max}$ [mm]	
$\phi 8$ to $\phi 10$	1000	1000
$\phi 12$ to $\phi 14$		1200
$\phi 16$		1500
$\phi 18$ to $\phi 20$	700	1300
$\phi 22$ to $\phi 25$		1000
$\phi 26$ to $\phi 28$	500	700
$\phi 30$ to $\phi 32$		
$\phi 34$ to $\phi 40$		500

Concrete

Chemical anchors

Mechanical anchors

Plastic/Light duty metal anchors

Insulation anchors

Setting instructions

*For detailed information on installation see instruction for use given with the package of the product,



Safety regulations,

Review the Material Safety Data Sheet (MSDS) before use for proper and safe handling! Wear well-fitting protective goggles and protective gloves when working with Hilti HIT-RE 100,

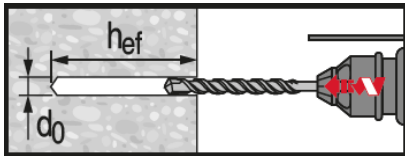

Hammer drilled hole

For dry and wet concrete,

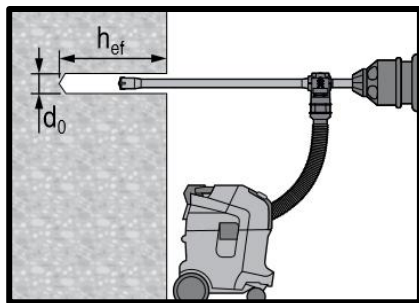

Hammer drilled hole with Hollow Drilled Bit (HDB)

No cleaning required,

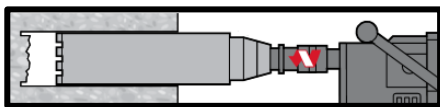

Diamond Drilling (DD)

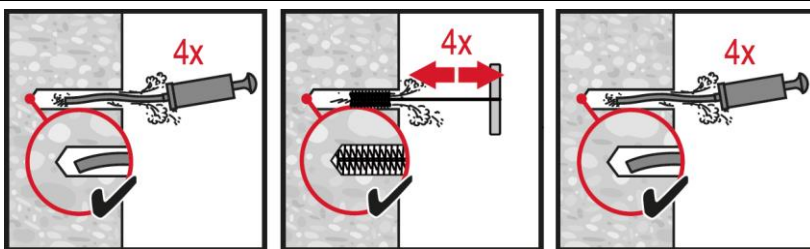

Hammer Drilling:

Manual cleaning (MC)

for drill diameters $d_0 \leq 20$ mm and drill hole depth $h_0 \leq 10 \cdot d$,

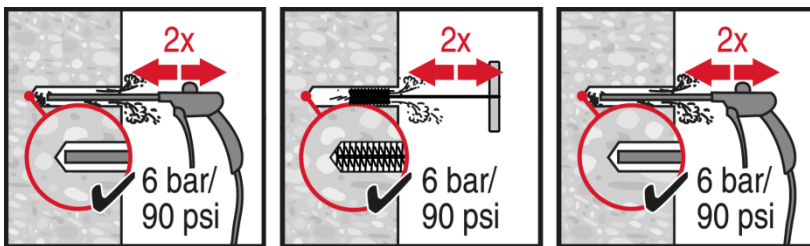

Hammer Drilling:

Compressed air cleaning (CAC)

for all drill hole diameters d_0 and drill hole depths $h_0 \leq 20 \cdot d$,

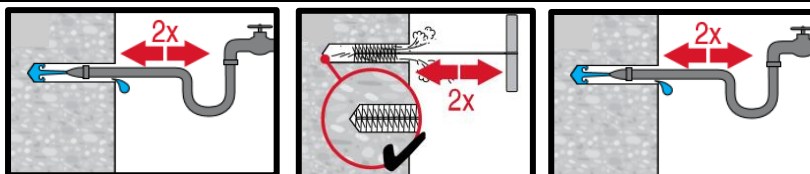

Wet diamond coring:

Compressed air cleaning (CAC)

for all drill hole diameters d_0 and drill hole depths h_0 ,

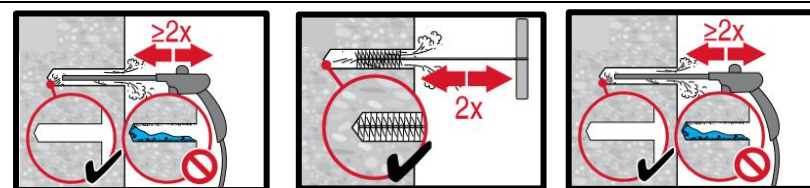

Dry diamond coring:

Compressed air cleaning (CAC)

for all drill hole diameters d_0 and drill hole depths h_0 ,

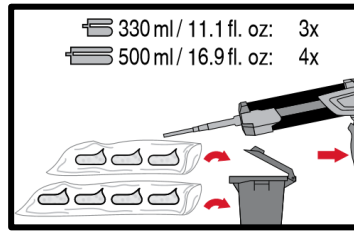
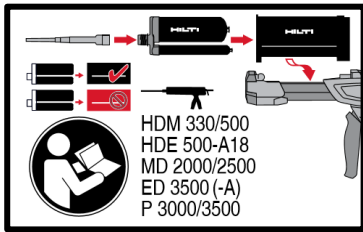

Injection system preparation,

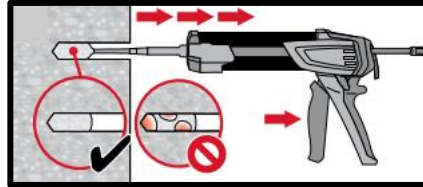
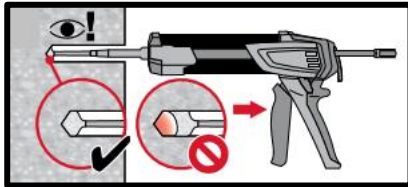

Injection method for drill hole depth
 $h_{ef} \leq 250$ mm,

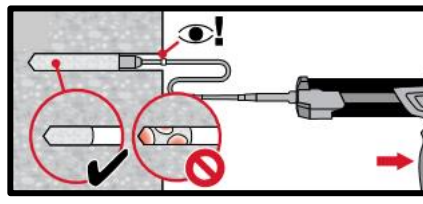
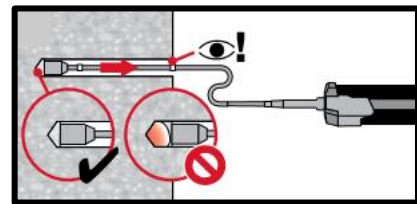

Injection method for drill hole depth
 $h_{ef} > 250$ mm,

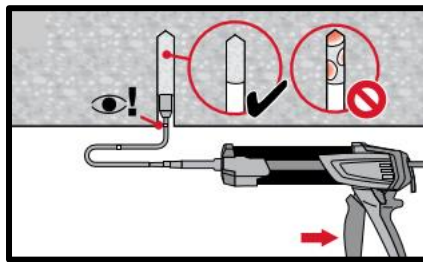
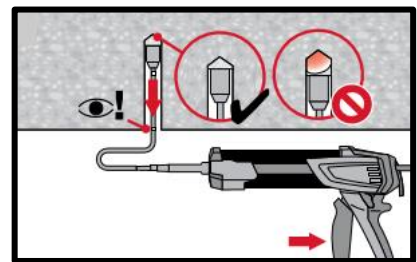

Injection method for overhead
application,

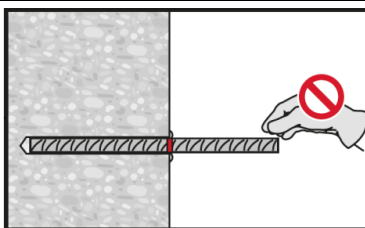
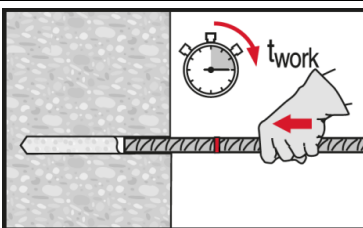

Setting element, observe working time
“ t_{work} ”,

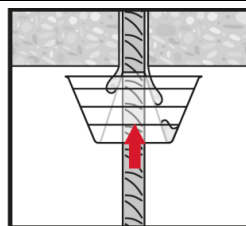
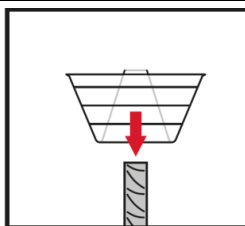
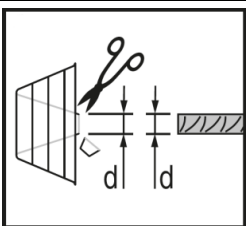

Setting element for overhead
applications, observe working time “ t_{work} ”,

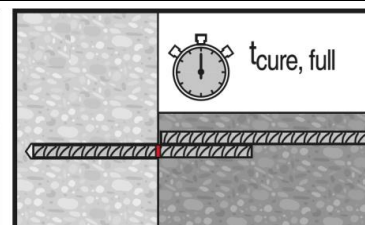
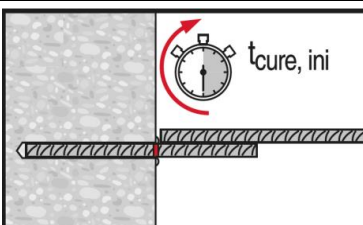
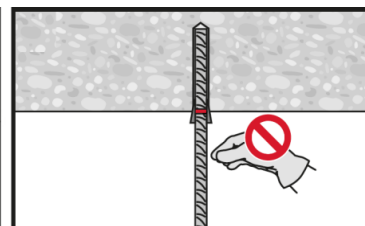
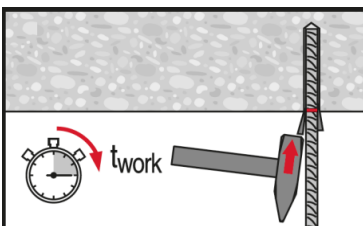

Apply full load only after curing time
“ t_{cure} ”,

HIT-HY 110 injection mortar

Anchor design (ETAG 001) / Rods&Sleeves / Concrete

Concrete

Chemical anchors

Mechanical anchors

Plastic/Light duty metal anchors

Insulation anchors

Injection mortar system

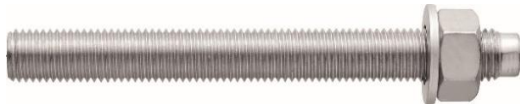

Hilti HIT-HY 110
330 ml foil pack
(also available as
500 ml and 1.400
ml foil pack)

Anchor rod:
HIT-V
HIT-V-F
HIT-V-R
HIT-V-HCR
(M8-M30)

Anchor rod:
HAS-(E)
HAS-(E)R
HAS-(E)RHCR
(M8-M30)

Internally threaded
sleeve:
HIS-N
HIS-RN
(M8-M20)

Benefits

- Suitable non-cracked concrete C 20/25 to C 50/60
- High corrosion ^{a)} / corrosion resistant
- Suitable for dry and water saturated concrete
- Small edge distance and anchor spacing possible
- Large diameter applications
- In service temperature range up to 120°C short term / 72°C long term

a) Applications only for HIT-V rods

Base material



Concrete (non-cracked)

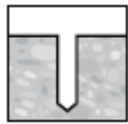

Dry concrete



Wet concrete

Load conditions

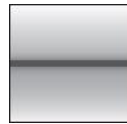

Static/
quasi-static

Installation conditions



Hammer
drilling

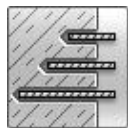

Variable
embedment
depth

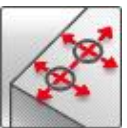

Small edge
distance and
spacing

Other informations



European
Technical
Assessment



CE
conformity

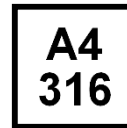

Corrosion
resistance



High
corrosion
resistance ^{a)}

a) Applications only for HIT-V rods

Approvals / certificates

Description	Authority / Laboratory	No. / date of issue
European technical assessment ^{a)}	DIBt, Berlin	ETA-08/0341 / 2013-03-18

a) All data given in this section according to ETA-08/0341 issue 2013-03-18.

Static and quasi-static loading (for a single anchor)

All data in this section applies to

- Correct setting (See setting instruction)
- No edge distance and spacing influence
- Steel failure
- Base material thickness, as specified in the table
- One typical embedment depth, as specified in the table
- One anchor material, as specified in the tables
- Concrete C 20/25, $f_{ck,cube} = 25 \text{ N/mm}^2$
- Temperate range I
(min. base material temperature -40°C , max. long term/short term base material temperature: $+24^\circ\text{C}/40^\circ\text{C}$)

Embedment depth and base material thickness

Anchor size	M8	M10	M12	M16	M20	M24	M27	M30
HIT-V								
Typical embedment depth h_{ef} [mm]	80	90	110	125	170	210	240	270
Base material thickness h [mm]	110	120	140	165	220	270	300	340
HIS-N								
Typical embedment depth [mm]	90	110	125	170	205	-	-	-
Base material thickness h [mm]	120	150	170	230	270	-	-	-

Mean ultimate resistance

Anchor size	M8	M10	M12	M16	M20	M24	M27	M30	
Tension $N_{Ru,m}$ [kN]	HIT-V 5.8	18,9	30,5	44,1	75,4	121,1	168,9	203,6	237,5
	HIS-N 8.8	26,3	48,3	70,4	123,9	114,5	-	-	-
Shear $V_{Ru,m}$ [kN]	HIT-V 5.8	9,5	15,8	22,1	41,0	64,1	92,4	120,8	147,0
	HIS-N 8.8	13,7	24,2	41,0	62,0	57,8	-	-	-

Characteristic resistance

Anchor size	M8	M10	M12	M16	M20	M24	M27	M30	
Tension N_{Rk} [kN]	HIT-V 5.8	18,0	29,0	42,0	56,5	90,8	126,7	152,7	178,1
	HIS-N 8.8	25,0	40,0	60,0	119,0	109,0	-	-	-
Shear V_{Rk} [kN]	HIT-V 5.8	9,0	15,0	21,0	39,0	61,0	88,0	115,0	140,0
	HIS-N 8.8	13,0	23,0	39,0	59,0	55,0	-	-	-

Design resistance

Anchor size	M8	M10	M12	M16	M20	M24	M27	M30	
Tension N_{Rd} [kN]	HIT-V 5.8	12,0	17,3	25,3	26,9	43,2	60,3	72,7	84,8
	HIS-N 8.8	17,5	26,7	40,0	62,2	74,1	-	-	-
Shear V_{Rd} [kN]	HIT-V 5.8	7,2	12,0	16,8	31,2	48,8	70,4	92,0	112,0
	HIS-N 8.8	10,4	18,4	26,0	39,3	36,7	-	-	-

Recommended loads ^{a)}

Anchor size	M8	M10	M12	M16	M20	M24	M27	M30	
Tension N_{Rec} [kN]	HIT-V 5.8	8,6	12,3	18,1	19,2	30,9	43,1	51,9	60,6
	HIS-N 8.8	12,5	19,0	28,6	44,4	53,0	-	-	-
Shear V_{Rec} [kN]	HIT-V 5.8	5,1	8,6	12,0	22,3	34,9	50,3	65,7	80,0
	HIS-N 8.8	7,4	13,1	18,6	28,1	26,2	-	-	-

a) With overall partial safety factor for action $\gamma=1,4$. The partial safety factors for action depend on the type of loading and shall be taken from national regulations.

Materials

Mechanical properties for HIT-V and HAS

Anchor size		M8	M10	M12	M16	M20	M24	M27	M30
Nominal tensile strength f_{uk}	HIT-V 5.8 HAS-(E) 5.8	500	500	500	500	500	500	500	500
	HIT-V 8.8	800	800	800	800	800	800	800	800
	HIT-V-R HAS-(E)R	700	700	700	700	700	700	500	500
	HIT-V-HCR HAS-(E)-HCR	800	800	800	800	800	700	700	700
Yield strength f_{yk}	HIT-V 5.8 HAS-(E) 5.8	400	400	400	400	400	400	400	400
	HIT-V 8.8 HAS-(E) 8.8	640	640	640	640	640	640	640	640
	HIT-V-R HAS-(E)R	450	450	450	450	450	450	210	210
	HIT-V-HCR HAS-(E)-HCR	600	600	600	600	600	400	400	400
Stressed cross-section A_s	HIT-V	36,6	58,0	84,3	157	245	353	459	561
	HAS-(E)	32,8	52,3	76,2	144,0	225,0	324,0	427	519
Moment of resistance W	HIT-V	31,2	62,3	109	277	541	935	1387	1874
	HAS-(E)	27,0	54,1	93,8	244,0	474,0	809,0	1274	1706

Mechanical properties for HIS-N

Anchor size		M8	M10	M12	M16	M20
Nominal tensile strength f_{uk}	HIS-N	490	490	460	460	460
	Screw 8.8	800	800	800	800	800
	HIS-RN	700	700	700	700	700
	Screw A4-70	700	700	700	700	700
Yield strength f_{yk}	HIS-N	410	410	375	375	375
	Screw 8.8	640	640	640	640	640
	HIS-RN	350	350	350	350	350
	Screw A4-70	450	450	450	450	450
Stressed cross-section	HIS-(R)N	51,5	108,0	169,1	256,1	237,6
	Screw	36,6	58	84,3	157	245
Moment of resistance W	HIS-(R)N	145	430	840	1595	1543
	Screw	31,2	62,3	109	277	541

Concrete
Chemical anchors
Mechanical anchors
Plastic/Light duty metal anchors
Insulation anchors

Material quality for HIT-V

Part	Material
Zinc coated steel	
Threaded rod, HIT-V 5.8 (F) HAS-(E) M8 to M24	Strength class 5.8; Elongation at fracture A5 > 8% ductile Electroplated zinc coated $\geq 5\mu\text{m}$; (F) hot dip galvanized $\geq 45\mu\text{m}$
Threaded rod, HIT-V 8.8 (F) HAS-(E) M27 to M30	Strength class 8.8; Elongation at fracture A5 > 12% ductile Electroplated zinc coated $\geq 5\mu\text{m}$; (F) hot dip galvanized $\geq 45\mu\text{m}$
Washer	Electroplated zinc coated $\geq 5\mu\text{m}$, hot dip galvanized $\geq 45\mu\text{m}$
Nut	Strength class of nut adapted to strength class of threaded rod. Electroplated zinc coated $\geq 5\mu\text{m}$, hot dip galvanized $\geq 45\mu\text{m}$
Stainless Steel	
Threaded rod, HIT-V-R HAS-(E)R	Strength class 70 for $\leq M24$ and strength class 50 for $> M24$; Elongation at fracture A5 > 8% ductile Stainless steel 1.4401; 1.4404; 1.4578; 1.4571; 1.4439; 1.4362
Washer	Stainless steel 1.4401, 1.4404, 1.4578, 1.4571, 1.4439, 1.4362 EN 10088-1:2014
Nut	Stainless steel 1.4401, 1.4404, 1.4578, 1.4571, 1.4439, 1.4362 EN 10088-1:2014
High corrosion resistant steel	
Threaded rod, HIT-V-HCR HAS-(E)HCR	Strength class 80 for $\leq M20$ and class 70 for $> M20$, Elongation at fracture A5 > 8% ductile High corrosion resistance steel 1.4529; 1.4565;
Washer	High corrosion resistant steel 1.4529, 1.4565 EN 10088-1:2014
Nut	High corrosion resistant steel 1.4529, 1.4565 EN 10088-1:2014

Material quality for HIS-N

Part	Material
HIS-N	Internal threaded sleeve C-steel 1.0718 Steel galvanized $\geq 5\mu\text{m}$
	Screw 8.8 Strength class 8.8, A5 > 8 % Ductile Steel galvanized $\geq 5\mu\text{m}$
HIS-RN	Internal threaded sleeve Stainless steel 1.4401, 1.4571
	Screw 70 Strength class 70, A5 > 8 % Ductile Stainless steel 1.4401; 1.4404, 1.4578; 1.4571; 1.4439; 1.4362

Setting information

Installation temperature range:

-5°C to +40°C

In service temperature range

Hilti HIT-HY 110 injection mortar may be applied in the temperature ranges given below. An elevated base material temperature may lead to a reduction of the design bond resistance.

Temperature range	Base material temperature	Max. long term base material temperature	Max. short term base material temperature
Temperature range I	-40 °C to + 40 °C	+ 24 °C	+ 40 °C
Temperature range II	-40 °C to + 80 °C	+ 50 °C	+ 80 °C
Temperature range II	-40 °C to + 120 °C	+ 72 °C	+ 120 °C

Max. short term base material temperature

Short term elevated base material temperatures are those that occur over brief intervals, e.g. as a result of diurnal cycling.

Max. long term base material temperature

Long term elevated base material temperatures are roughly constant over significant periods of time.

Working time and curing time

Temperature in the anchorage base	Maximum working time t_{work}	Minimum curing time t_{cure}
$-5^{\circ}\text{C} < T_{BM} \leq 0^{\circ}\text{C}$	90 min	9 h
$0^{\circ}\text{C} < T_{BM} \leq 5^{\circ}\text{C}$	45 min	4,5 h
$5^{\circ}\text{C} < T_{BM} \leq 10^{\circ}\text{C}$	25 min	2 h
$10^{\circ}\text{C} < T_{BM} \leq 20^{\circ}\text{C}$	6 min	90 min
$20^{\circ}\text{C} < T_{BM} \leq 30^{\circ}\text{C}$	4 min	50 min
$30^{\circ}\text{C} < T_{BM} \leq 40^{\circ}\text{C}$	2 min	40 min

The curing time data are valid for dry base material only. In wet base material the curing times must be doubled.

Setting details for HIT-V and HAS

Anchor size	M8	M10	M12	M16	M20	M24	M27	M30	
Nominal diameter of drill bit d_0 [mm]	10	12	14	18	22	28	30	35	
Diameter of element d [mm]	8	10	12	16	20	24	27	30	
Effective anchorage and drill hole depth ^{a)} for HIT-V	$\frac{h_{ef,min}}{h_{ef,max}}$ [mm]	60	60	70	80	90	100	110	120
		160	200	240	320	400	480	540	600
Effective anchorage and drill hole depth ^{a)} for HAS	h_{ef} [mm]	80	90	110	125	170	210	240	270
Minimum base material thickness h_{min} [mm]	$h_{ef} + 30$			$h_{ef} + 2 d_0$					
Diameter of clearance hole in the fixture $d_f \leq$ [mm]	9	12	14	18	22	26	30	33	
Torque moment ^{b)} T_{max} [Nm]	10	20	40	80	150	200	270	300	
Min. spacing s_{min} [mm]	40	50	60	80	100	120	135	150	
Min. edge distance c_{min} [mm]	40	50	60	80	100	120	135	150	
Critical spacing for splitting failure $s_{cr,sp}$ [mm]	$2 C_{cr,sp}$								
Critical edge distance for splitting failure ^{c)} $C_{cr,sp}$ [mm]	$1,0 \cdot h_{ef}$ for $h / h_{ef} \geq 2,0$								
	$4,6 h_{ef} - 1,8 h$ for $2,0 > h / h_{ef} > 1,3$								
	$2,26 h_{ef}$ for $h / h_{ef} \leq 1,3$								
Critical spacing for concrete cone failure $s_{cr,N}$ [mm]	$2 C_{cr,N}$								
Critical edge distance for concrete cone failure ^{d)} $C_{cr,N}$ [mm]	$1,5 h_{ef}$								

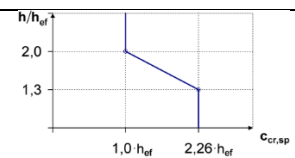

For spacing (edge distance) smaller than critical spacing (critical edge distance) the design loads have to be reduced.

- $h_{ef,min} \leq h_{ef} \leq h_{ef,max}$ (h_{ef} : embedment depth)
- Maximum recommended torque moment to avoid splitting failure during installation with minimum spacing anchor edge distance
- h : base material thickness ($h \geq h_{min}$)
- The critical edge distance for concrete cone failure depends on the embedment depth h_{ef} and the design bond resistance. The simplified formula given in this table is on the safe side.

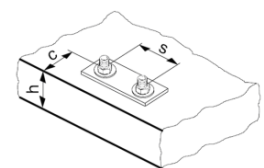

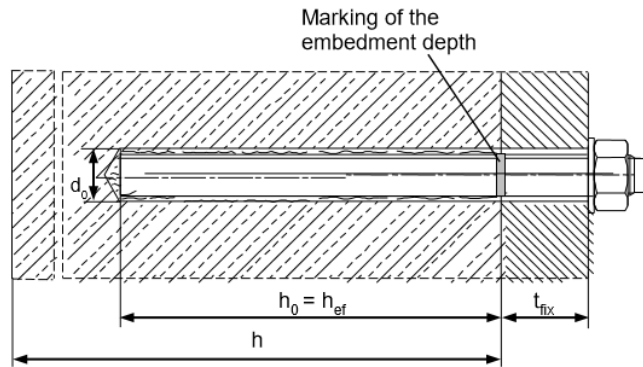

Setting details for HIS-N

Anchor size		M8	M10	M12	M16	M20
Nominal diameter of drill bit	d_0 [mm]	14	18	22	28	32
Diameter of element	d [mm]	12,5	16,5	20,5	25,4	27,6
Effective anchorage and drill hole depth	h_{ef} [mm]	90	110	125	170	205
Minimum base material thickness	h_{min} [mm]	120	150	170	230	270
Diameter of clearance hole in the fixture	d_f [mm]	9	12	14	18	22
Thread engagement length min-max	h_s [mm]	8-20	10-25	12-30	16-40	20-50
Min. spacing	s_{min} [mm]	40	45	55	65	90
Min. edge distance	c_{min} [mm]	40	45	55	65	90
Critical spacing for splitting failure	$s_{cr,sp}$ [mm]	$2 C_{cr,sp}$				
Critical edge distance for splitting failure ^{a)}	$C_{cr,sp}$ [mm]	$1,0 \cdot h_{ef}$ for $h / h_{ef} \geq 2,0$				
		$4,6 h_{ef} - 1,8 h$ for $2,0 > h / h_{ef} > 1,3$				
		$2,26 h_{ef}$ for $h / h_{ef} \leq 1,3$				
Critical spacing for concrete cone failure	$s_{cr,N}$ [mm]	$2 C_{cr,N}$				
Critical edge distance for concrete cone failure ^{b)}	$C_{cr,N}$ [mm]	$1,5 h_{ef}$				
Torque moment ^{c)}	T_{max} [Nm]	10	20	40	80	150

For spacing (edge distance) smaller than critical spacing (critical edge distance) the design loads have to be reduced.

- h : base material thickness ($h \geq h_{min}$), h_{ef} : embedment depth
- The critical edge distance for concrete cone failure depends on the embedment depth h_{ef} and the design bond resistance. The simplified formula given in this table is on the safe side.
- Maximum recommended torque moment to avoid splitting failure during installation with minimum spacing and/or edge distance.

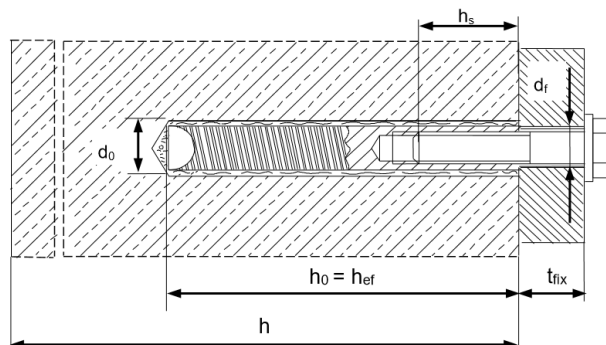
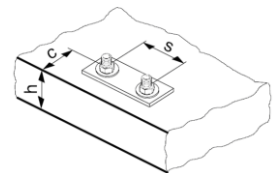

Installation equipment

Anchor size	M8	M10	M12	M16	M20	M24	M27	M30
Rotary hammer	HIT-V / HAS	TE 2– TE 30			TE 40 – TE 80			
	HIS-N	TE 2– TE 30		TE 40 – TE 80		-		
Other tools	compressed air gun or blow out pump set of cleaning brushes, dispenser							

Drilling and cleaning parameters

HIT-V HAS	HIS-N	Hammer drill	Brush HIT-RB	Piston plug HIT-SZ
		d_0 [mm]	size [mm]	
M8	-	10	10	-
M10	-	12	12	12
M12	M8	14	14	14
M16	M10	18	18	18
M20	M12	22	22	22
M24	M16	28	28	28
M27	-	30	30	30
-	M20	32	32	32
M30	-	35	35	35

Setting instructions

*For detailed information on installation see instruction for use given with the package of the product.



Safety regulations.

Review the Material Safety Data Sheet (MSDS) before use for proper and safe handling! Wear well-fitting protective goggles and protective gloves when working with Hilti HIT-HY 110.

Drilling

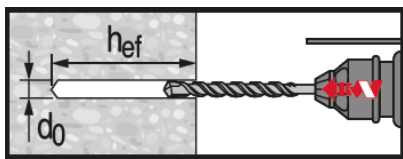

Hammer drilled hole (HD)

Cleaning

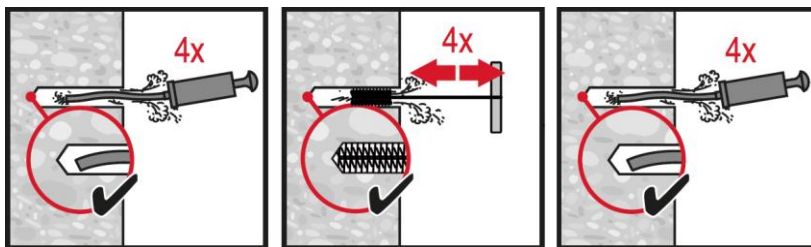

Manual cleaning (MC)
Non-cracked concrete only

for drill diameters $d_0 \leq 18$ mm and drill hole depth $h_0 \leq 10 \cdot d$ or $h_0 \leq 160$.

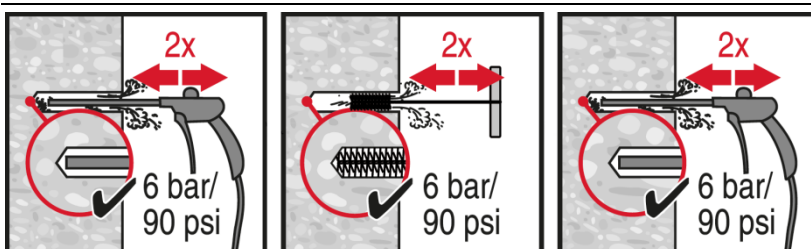

Compressed air cleaning (CAC)

for all drill hole diameters d_0 and drill hole depths h_0 .

Concrete
Chemical anchors
Mechanical anchors
Plastic/Light duty metal anchors
Insulation anchors

Injection system

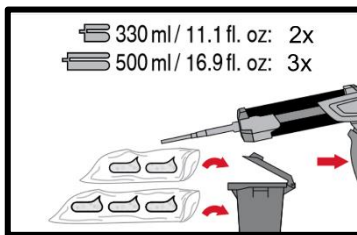
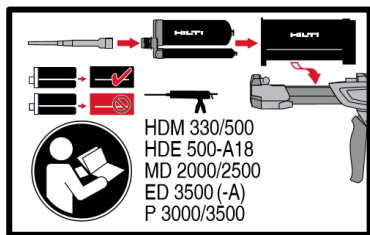

Injection system preparation.

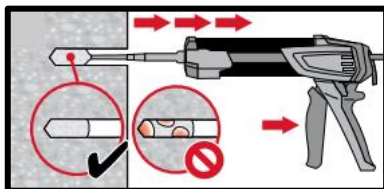
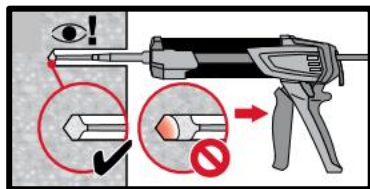

Injection method for drill hole depth $h_{ef} \leq 250$ mm.

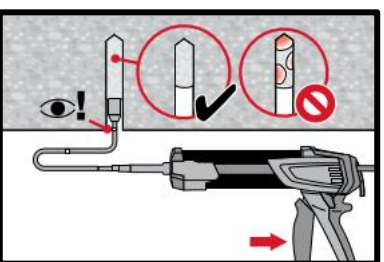
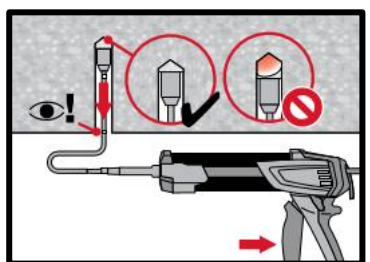

Injection method for overhead application or installation with embedment depth $h_{ef} > 250$ mm.

Setting the element

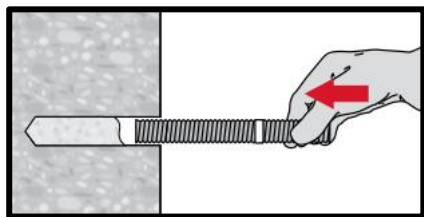

Setting element, observe working time t_{work} ,

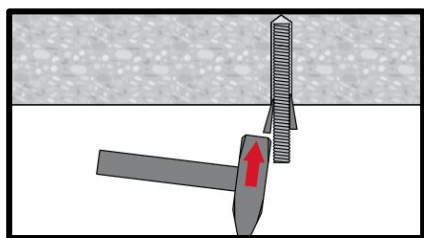

Setting element for overhead applications, observe working time t_{work} ,

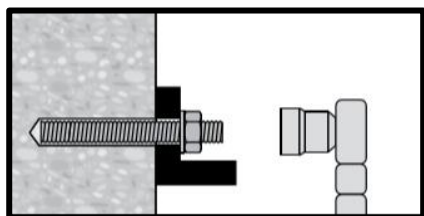

Loading the anchor: After required curing time t_{cure} the anchor can be loaded.

HIT-HY 110 injection mortar

Anchor design (ETAG 001) / Rebar elements / Concrete

Injection mortar system



Hilti HIT-HY 110
330 ml foil pack
(also available as
500 ml and 1.400
ml foil pack)



Rebar B St 500 S
(φ8-φ25)

Benefits

- Suitable non-cracked concrete C 20/25 to C 50/60
- Suitable for dry and water saturated concrete
- Small edge distance and anchor spacing possible
- Large diameter applications
- In service temperature range up to 120°C short term / 72°C long term

Base material



Concrete (non-cracked)



Dry concrete



Wet concrete

Load conditions

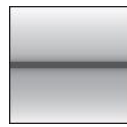

Static/
quasi-static

Installation conditions

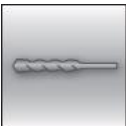

Hammer
drilling

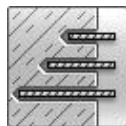

Variable
embedment
depth

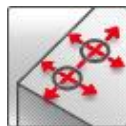

Small edge
distance and
spacing

Other informations



European
Technical
Assessment



CE
conformity

b) Applications only for HIT-V rods

Approvals / certificates

Description	Authority / Laboratory	No. / date of issue
European technical assessment ^{a)}	DIBt, Berlin	ETA-08/0341 / 2013-03-18

b) All data given in this section according to ETA-08/0341 issue 2013-03-18.

Static and quasi-static loading (for a single anchor)

All data in this section applies to

- Correct setting (See setting instruction)
- No edge distance and spacing influence
- Steel failure
- Base material thickness, as specified in the table
- One typical embedment depth, as specified in the table
- Anchor material: Rebar B St 500 S
- Concrete C 20/25, $f_{ck,cube} = 25 \text{ N/mm}^2$
- Temperature range I
(min. base material temperature -40°C, max. long term/short term base material temperature: +24°C/40°C)

Embedment depth ^{a)} and base material thickness for static and quasi-static loading data

Anchor- size	φ8	φ10	φ12	φ14	φ16	φ20	φ25
Typical embedment depth [mm]	80	90	110	125	170	210	240
Base material thickness [mm]	110	120	140	165	220	270	300

a) The allowed range of embedment depth is shown in the setting details. The corresponding load values can be calculated according to the simplified design method.

Mean ultimate resistance

Anchor- size	φ8	φ10	φ12	φ14	φ16	φ20	φ25
Tensile $N_{Ru,m}$	22,8	32,0	47,0	55,0	72,9	106,8	164,9
Shear $V_{Ru,m}$ [kN]	14,7	23,1	32,6	44,1	57,8	90,3	141,8

Characteristic resistance

Anchor- size	φ8	φ10	φ12	φ14	φ16	φ20	φ25
Tensile N_{Rk}	17,1	24,0	35,2	41,2	54,7	80,1	123,7
Shear V_{Rk} [kN]	9,3	14,7	20,7	28,0	36,7	57,3	90,0

Design resistance

Anchor- size	φ8	φ10	φ12	φ14	φ16	φ20	φ25
Tensile N_{Rd}	11,4	13,4	19,6	19,6	26,0	38,1	58,9
Shear V_{Rd} [kN]	9,3	14,7	20,7	28,0	36,7	57,3	90,0

Recommended loads ^{a)}

Anchor- size	φ8	φ10	φ12	φ14	φ16	φ20	φ25
Tensile N_{Rec}	8,1	9,5	14,0	14,0	18,6	27,2	42,1
Shear V_{Rec} [kN]	6,7	10,5	14,8	20,0	26,2	41,0	64,3

a) With overall partial safety factor for action $\gamma = 1,4$. The partial safety factors for action depend on the type of loading and shall be taken from national regulations.

Materials

Mechanical properties

Anchor size	φ8	φ10	φ12	φ14	φ16	φ20	φ25
Nominal tensile strength f_{uk} [N/mm ²]	550	550	550	550	550	550	550
Yield strength f_{yk} [N/mm ²]	500	500	500	500	500	500	500
Stressed cross-section A_s [mm ²]	50,3	78,5	113,1	153,9	201,1	314,2	490,9
Moment of resistance W [mm ³]	50,3	98,2	169,6	269,4	402,1	785,4	1534

Material quality

Part	Material
Rebar EN 1992-1-1	Mechanical properties according to DIN 488-1:1984 Geometry according to DIN 488-21:1986

Setting information

Installation temperature range:
-5°C to +40°C

In service temperature range

Hilti HIT-HY 110 injection mortar may be applied in the temperature ranges given below. An elevated base material temperature may lead to a reduction of the design bond resistance.

Temperature range	Base material temperature	Max. long term base material temperature	Max. short term base material temperature
Temperature range I	- 40 °C to + 40 °C	+ 24 °C	+ 40 °C
Temperature range II	- 40 °C to + 80 °C	+ 50 °C	+ 80 °C
Temperature range III	- 40 °C to + 120 °C	+ 72 °C	+ 120 °C

Max. short term base material temperature

Short term elevated base material temperatures are those that occur over brief intervals, e.g. as a result of diurnal cycling.

Max. long term base material temperature

Long term elevated base material temperatures are roughly constant over significant periods of time.

Working time and curing time

Temperature in the anchorage base	Maximum working time t_{work}	Minimum curing time t_{cure}
$-5^{\circ}\text{C} < T_{BM} \leq 0^{\circ}\text{C}$	90 min	9 h
$0^{\circ}\text{C} < T_{BM} \leq 5^{\circ}\text{C}$	45 min	4,5 h
$5^{\circ}\text{C} < T_{BM} \leq 10^{\circ}\text{C}$	25 min	2 h
$10^{\circ}\text{C} < T_{BM} \leq 20^{\circ}\text{C}$	6 min	90 min
$20^{\circ}\text{C} < T_{BM} \leq 30^{\circ}\text{C}$	4 min	50 min
$30^{\circ}\text{C} < T_{BM} \leq 40^{\circ}\text{C}$	2 min	40 min

The curing time data are valid for dry base material only. In wet base material the curing times must be doubled.

Setting details

Anchor size		$\phi 8$	$\phi 10$	$\phi 12$	$\phi 14$	$\phi 16$	$\phi 20$	$\phi 25$
Nom. diameter of drill bit	d_0 [mm]	10 / 12 ^{a)}	12 / 14 ^{a)}	14 ^{a)} / 16 ^{a)}	18	20	25	32
Effective anchorage and drill hole depth range	$h_{ef,min}$ [mm]	60	60	70	75	80	90	100
	$h_{ef,max}$ [mm]	160	200	240	280	320	400	500
Minimum base material thickness	h_{min} [mm]	$h_{ef} + 30 \text{ mm}$ $\geq 100 \text{ mm}$			$h_{ef} + 2 d_0$			
Min. spacing	s_{min} [mm]	40	50	60	70	80	100	125
Min. edge distance	c_{min} [mm]	40	50	60	70	80	100	125
Critical spacing for splitting failure	$s_{cr,sp}$ [mm]	$2 C_{cr,sp}$						
Critical edge distance for splitting failure ^{b)}	$C_{cr,sp}$ [mm]	$1,0 \cdot h_{ef}$		for $h / h_{ef} \geq 2,0$				
		$4,6 h_{ef} - 1,8 h$		for $2,0 > h / h_{ef} > 1,3$				
		$2,26 h_{ef}$		for $h / h_{ef} \leq 1,3$				
Critical spacing for concrete cone failure	$s_{cr,N}$ [mm]	$2 C_{cr,N}$						
Critical edge distance for concrete cone failure ^{c)}	$C_{cr,N}$ [mm]	$1,5 h_{ef}$						

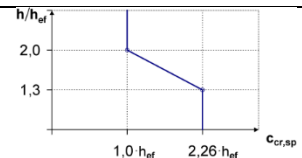

For spacing (edge distance) smaller than critical spacing (critical edge distance) the design loads have to be reduced.

a) Each of the two given values can be used.

b) h : base material thickness ($h \geq h_{min}$), h_{ef} : embedment depth

c) The critical edge distance for concrete cone failure depends on the embedment depth h_{ef} and the design bond resistance. The simplified formula given in this table is on the safe side.

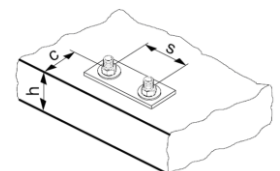

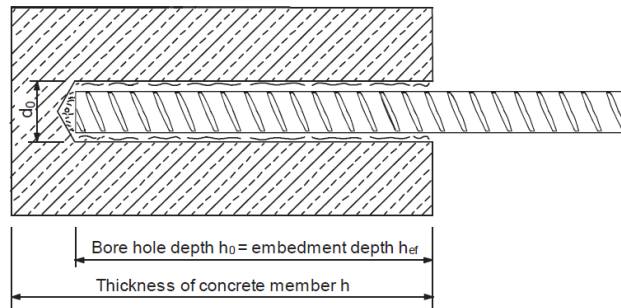

Installation equipment

Anchor size	$\phi 8$	$\phi 10$	$\phi 12$	$\phi 14$	$\phi 16$	$\phi 20$	$\phi 25$
Rotary hammer	TE 2 – TE 30					TE 40 – TE 70	
Other tools	compressed air gun or blow out pump set of cleaning brushes, dispenser						

Drilling and cleaning parameters

Rebar	Hammer drilling (HD)	Brush HIT-RB	Piston plug HIT-SZ
	d_0 [mm]	size [mm]	
$\phi 8$	10 / 12 ^{a)}	10 / 12 ^{a)}	- / 12
$\phi 10$	12 / 14 ^{a)}	12 / 14 ^{a)}	12 / 14 ^{a)}
$\phi 12$	14 / 16 ^{a)}	14 / 16 ^{a)}	14 / 16 ^{a)}
$\phi 14$	18	18	18
$\phi 16$	20	20	20
$\phi 20$	25	25	25
$\phi 25$	32	32	32

a) Each of the two given values can be used

Setting instructions

*For detailed information on installation see instruction for use given with the package of the product.



Safety regulations.

Review the Material Safety Data Sheet (MSDS) before use for proper and safe handling! Wear well-fitting protective goggles and protective gloves when working with Hilti HIT-HY 110.

Drilling

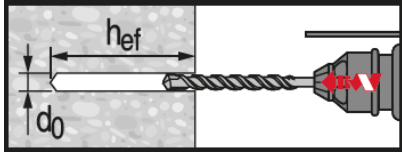

Hammer drilled hole (HD)

Cleaning

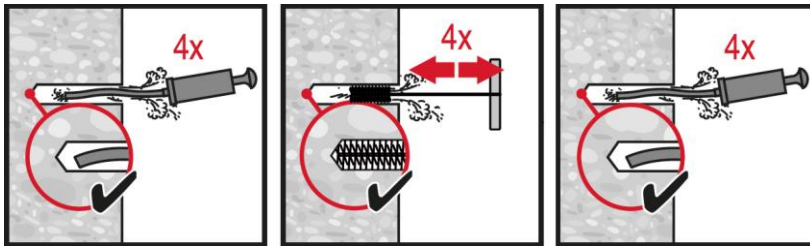

Manual cleaning (MC)
Non-cracked concrete only

for drill diameters $d_0 \leq 18$ mm and drill hole depth $h_0 \leq 10 \cdot d$ or $h_0 \leq 160$.

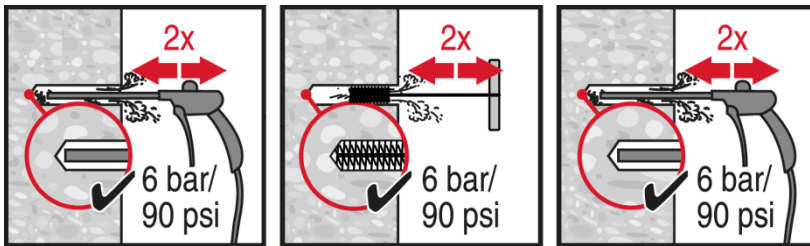

Compressed air cleaning (CAC)

for all drill hole diameters d_0 and drill hole depths h_0 .

Injection system

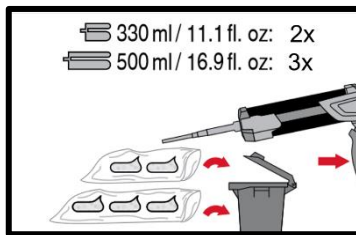
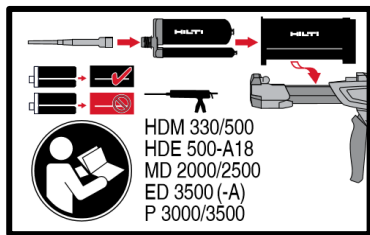

Injection system preparation.

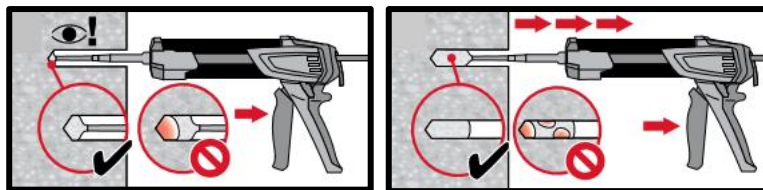

Injection method for drill hole depth
 $h_{ef} \leq 250$ mm.

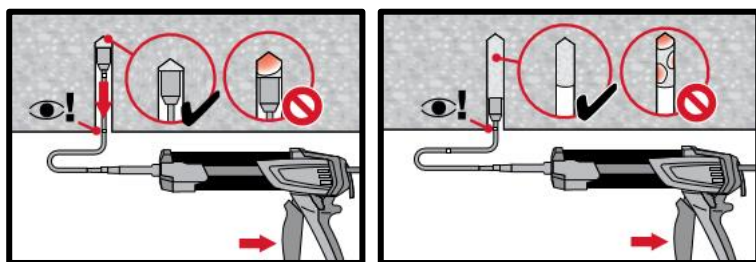

Injection method for overhead
application or installation with
embedment depth $h_{ef} > 250$ mm.

Setting the element

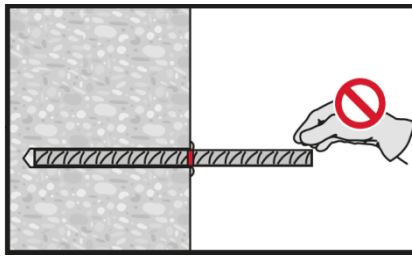
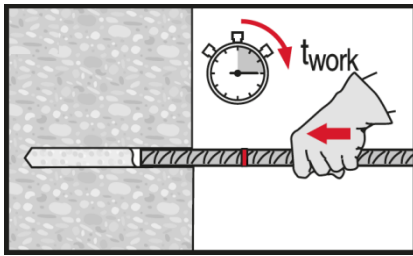

Setting element, observe working time " t_{work} ".

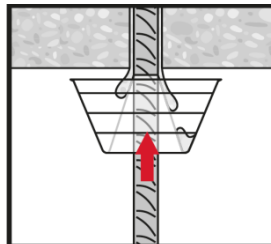
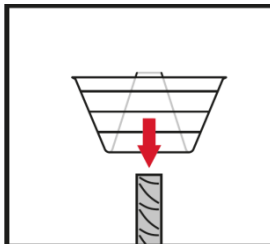
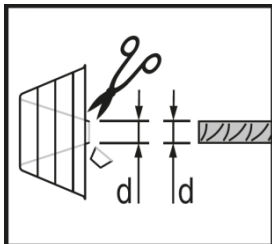

Setting element for overhead applications, observe working time " t_{work} ".

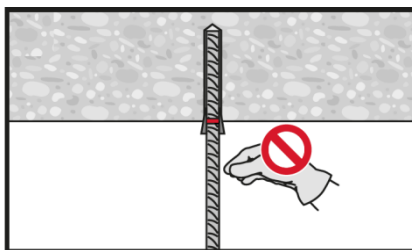
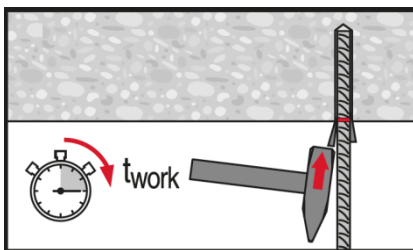

Loading the anchor: After required curing time t_{cure} the anchor can be loaded.

HIT-HY 110 injection mortar

Rebar design (EN 1992-1) / Rebar elements / Concrete



Concrete





Chemical anchors

Mechanical anchors

Plastic/Light duty metal anchors

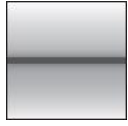
Insulation anchors

Injection mortar system		Benefits
	Hilti HIT-HY 110	<ul style="list-style-type: none"> - Suitable for concrete C 12/15 to C 50/60 - Suitable for dry and water saturated concrete - For rebar diameters up to 25 mm - Non corrosive to rebar elements - Good loading capacity and fast cure - Suitable for applications down to -5 °C - Suitable for embedment depth up to 1500 mm depending on the rebar diameter
	500 ml foil pack (also available as 330 ml foil pack)	
	Rebar (φ8-φ25)	

Base material	Load conditions
 <p>Concrete (non-cracked)</p>	 <p>Static/quasi-static</p>
Installation conditions	Other information
 <p>Hammer drilled holes</p>	 <p>European Technical Assessment</p>  <p>CE conformity</p>

Approvals / certificates

Description	Authority / Laboratory	No. / date of issue
European technical approval	DIBt, Berlin	ETA-13/1037 / 2014-05-26

a) All data given in this section according to ETA-13/1037, issue 2014-05-26.

Static and quasi-static loading

Design bond strength in N/mm² according to ETA 11/0492 for good bond conditions for hammer drilling and compressed air drilling.

Rebar (mm)	Concrete class								
	C12/15	C16/20	C20/25	C25/30	C30/37	C35/45	C40/50	C45/55	C50/60
8 - 25	1,6	2,0	2,3	2,7	3,0	3,0	3,0	3,4	3,7

For all other bond conditions, multiply the value by 0.7.

Anchorage length

The minimum anchorage length $\ell_{b,min}$ and the minimum lap length $\ell_{0,min}$ according to EN 1992-1-1:2004+AC:2010 ($\ell_{b,min}$ acc. to Eq. 8.6 and Eq. 8.7 and $\ell_{0,min}$ acc. to Eq. 8.11) shall be multiplied by a factor according to Table below.

Concrete class	Drilling method	Factor
C12/15 to C25/30	Hammer drilling (HD) and compressed air drilling (CA)	1,0
C30/37		1,1
C35/45 to C40/50		1,2
C45/55 to C50/60		1,3

Example of pre-calculated values for rebar yield strength $f_{yk} = 500 \text{ N/mm}^2$, concrete C25/30 and good bond conditions

Rebar	Anchorage length l_{bd}	Design value N_{Rd}	Mortar volume	Anchorage length l_{bd}	Design value N_{Rd}	Mortar volume
[mm]	[mm]	[kN]	[ml]	[mm]	[kN]	[ml]
All $\alpha = 1$				One of the $\alpha = 0.7$		
8	100 (minimum)	6,8	7,5	100	9,7	8
	170	11,5	13	140	13,6	11
	250	17,0	19	180	17,4	14
	322 (yielding)	21,9	24	225	21,8	17
10	121	10,3	11	121	14,7	11
	220	18,7	20	170	20,6	15
	310	26,3	28	230	27,9	21
	403	34,2	36	282	34,2	26
12	145	14,8	15	145	21,1	15
	260	26,5	27	210	30,5	22
	370	37,7	39	270	39,3	29
	483	49,2	51	338	49,1	36
14	169	20,1	20	169	28,7	20
	300	35,6	36	240	40,7	29
	430	51,1	52	320	54,3	39
	564	67,0	68	395	67,0	48
16	193	26,2	26	193	37,4	26
	340	46,1	46	280	54,3	38
	490	66,5	67	370	71,7	50
	644	87,4	87	451	87,4	61
18	218	33,3	33	218	47,5	33
	310	47,3	47	310	67,6	47
	410	62,6	62	410	89,4	62
	500	76,3	75	500	109,1	75
20	242	41,1	51	242	58,6	51
	330	56,0	70	330	80,0	70
	410	69,6	87	410	99,4	87
	500	84,8	106	500	121,2	106
22	266	49,6	75	266	70,9	75
	340	63,4	96	340	90,6	96
	420	78,4	119	420	112,0	119
	500	93,3	141	500	133,3	141
24	290	59,0	122	290	84,3	122
	360	73,3	152	360	104,7	152
	430	87,5	182	430	125,1	182
	500	101,8	211	500	145,4	211
25	302	64,0	114	302	91,5	114
	370	78,5	139	370	112,1	139
	430	91,2	162	430	130,3	162
	500	106,0	188	500	151,5	188

* Values corresponding to the minimum anchorage length. The maximum permissible load is valid for "good bond conditions" as described in EN 1992-1-1. For all other conditions multiply by the value by 0,7. The volume of mortar correspond to the formula " $1,2 \cdot (d_0^2 - d_s^2) \cdot \pi \cdot l_b / 4$ " for hammer drilling

Materials
Material quality

Part	Material
Rebar EN 1992-1-1	Bars and de-coiled rods class B or C with f_{yk} and k according to NDP or NCL of EN 1992-1-1 $f_{uk} = f_{tk} = k \cdot f_{yk}$

Fitness for use

Temperature range	Base material temperature	Max. long term base material temperature	Max. short term base material temperature
Temperature range II	- 40 °C to + 80 °C	+ 50 °C	+ 80 °C





Curing and working time

Temperature of the base material T_{BM}	Working time $t_{work}^{a)}$	Curing time t_{cure}
-5 °C to -1 °C	90 min	9 h
0 °C to 4 °C	45 min	4,5 h
5 °C to 9 °C	20 min	2 h
10 °C to 19 °C	6 min	90 min
20 °C to 29 °C	4 min	50 min
30 °C to 40 °C ^{b)}	2 min	40 min

Setting information
Installation equipment

Rebar [mm]	φ8	φ10	φ12	φ14	φ16	φ18	φ20	φ22	φ24	φ25
Rotary hammer	TE 2 – TE 40					TE 40 – TE 70				
Other tools	compressed air gun or blow out pump, set of cleaning brushes									

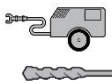
Drilling and cleaning diameters

Rebar [mm]	Hammer drill (HD)	Compressed air drill (CA)	Brush HIT-RB	Air nozzle HIT-RB
	d ₀ [mm]		size [mm]	
				
φ8	12 / 10 ^{a)}	-	12 / 10 ^{a)}	12 / 10 ^{a)}
φ10	14 / 12 ^{a)}	-	14 / 12 ^{a)}	14 / 12 ^{a)}
φ12	16 / 14 ^{a)}	-	16 / 14 ^{a)}	16 / 14 ^{a)}
	-	17	18	16
φ14	18	17	18	18
	20	-	20	20
φ16	-	20	22	20
	22	22	22	22
φ18	25	-	25	25
	-	26	28	25
φ22	28	28	28	28
φ24	32	32	32	32
φ25	32	32	32	-

a) Maximum installation length l=250 mm.

Dispensers and corresponding maximum embedment depth $l_{v,max}$

Rebar	Dispenser	
	HDM 330, HDM 500	HDE 500
	$l_{v,max}$ [mm]	$l_{v,max}$ [mm]
φ8 - φ10	700	1000
φ12	700	1150
φ14	700	1300
φ16	700	1500
φ18 - φ25	500	500

Setting instructions

*For detailed information on installation see instruction for use given with the package of the product.



Safety regulations.

Review the Material Safety Data Sheet (MSDS) before use for proper and safe handling! Wear well-fitting protective goggles and protective gloves when working with Hilti HIT-HY 110.

Drilling

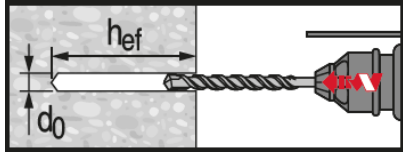

Hammer drilled hole (HD)

Cleaning

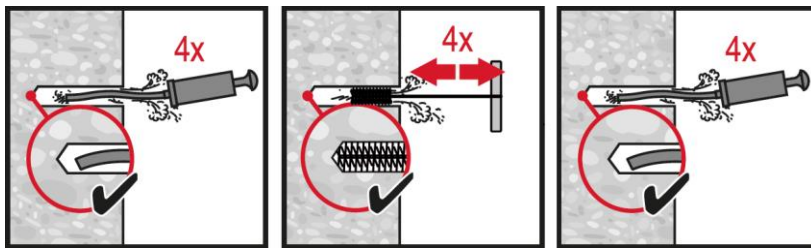

Manual cleaning (MC)
Non-cracked concrete only

for drill diameters $d_0 \leq 18$ mm and drill hole depth $h_0 \leq 10 \cdot d$ or $h_0 \leq 160$.

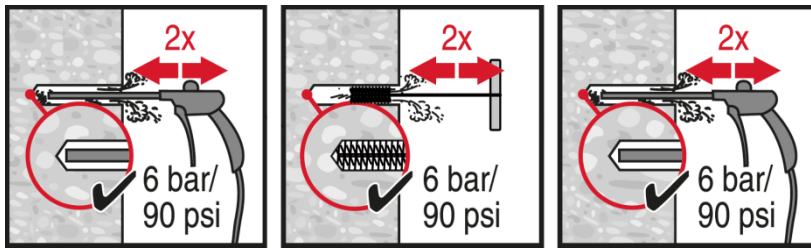

Compressed air cleaning (CAC)

for all drill hole diameters d_0 and drill hole depths h_0 .

Injection system

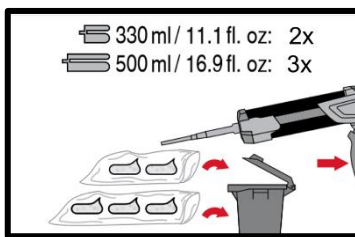
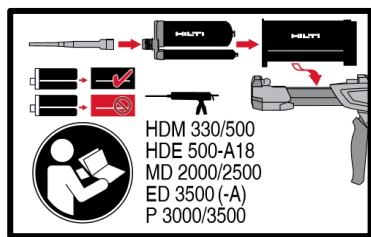

Injection system preparation.

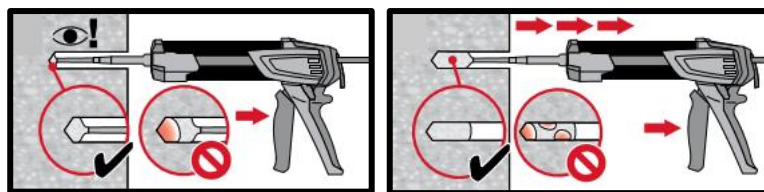

Injection method for drill hole depth
 $h_{ef} \leq 250$ mm.

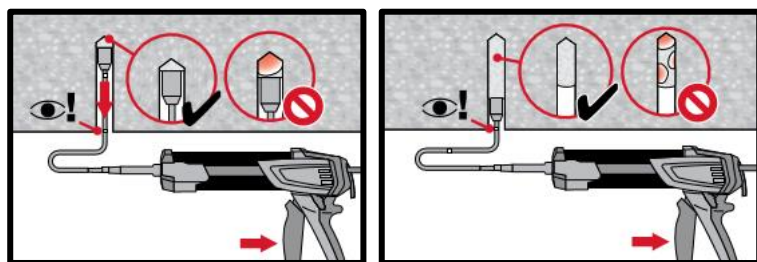

Injection method for overhead application or installation with embedment depth
 $h_{ef} > 250$ mm.

Setting the element

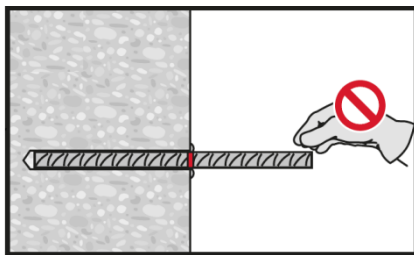
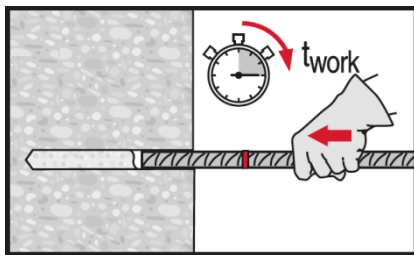

Setting element, observe working time " t_{work} ".

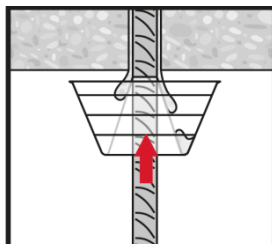
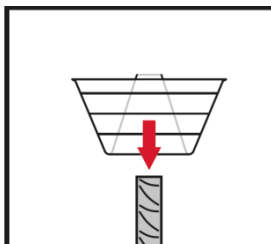
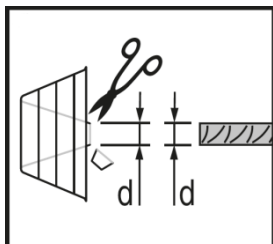

Setting element for overhead applications, observe working time " t_{work} ".

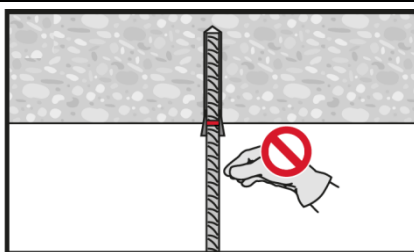
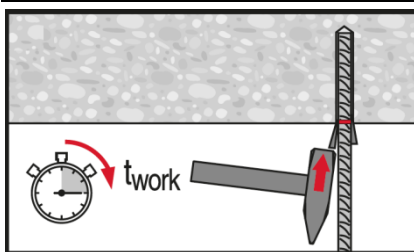

Loading the anchor: After required curing time t_{cure} the anchor can be loaded.

HIT-HY 100 injection mortar

Anchor design (ETAG 001) / Rods&Sleeves / Concrete

Concrete

Chemical anchors

Mechanical anchors

Plastic/Light duty metal anchors

Insulation anchors

Injection mortar system



Hilti HIT-HY 100
330 ml foil pack
(also available as
500 ml foil pack)

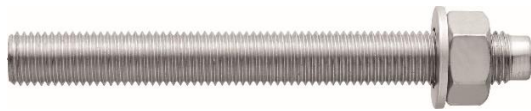

Anchor rod:
HIT-V
HIT-V-F
HIT-V-R
HIT-V-HCR
(M8-M30)



Internally threaded
sleeve:
HIS-N
HIS-RN sleeves
(M8-M20)

Benefits

- Suitable for cracked^{a)} and non-cracked concrete C 20/25 to C 50/60
- High corrosion^{a)} / corrosion resistant
- Suitable for dry and water saturated concrete
- Small edge distance and anchor spacing possible
- In service temperature range up to 80°C short term / 50°C long term

a) Applications only with HIT-V anchor rods

Base material



Concrete
(non-cracked)

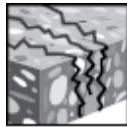

Concrete
(cracked)^{a)}



Dry concrete



Wet
concrete

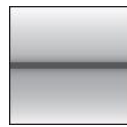

Static/
quasi-static

Load conditions

Installation conditions

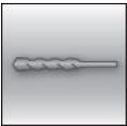

Hammer
drilling

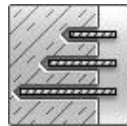

Variable
embedment
depth

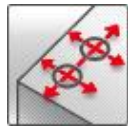

Small edge
distance and
spacing

a) Applications only for HIT-V rods.

Other informations



European
Technical
Assessment



CE
conformity

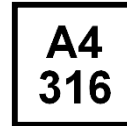

Corrosion
resistance



High
corrosion
resistance^{a)}

Approvals / certificates

Description	Authority / Laboratory	No. / date of issue
European technical assessment ^{a)}	CSTB, Marne-la-Vallée	ETA-14/0009 / 2014-05-24

a) All data given in this section according to ETA-14/0009 issue 2014-05-24.

Static and quasi-static loading (for a single anchor)

All data in this section applies to

- Correct setting (See setting instruction)
- No edge distance and spacing influence
- Steel failure
- Base material thickness, as specified in the table
- One typical embedment depth, as specified in the table
- One anchor material, as specified in the tables
- Concrete C 20/25, $f_{ck,cube} = 25 \text{ N/mm}^2$
- Temperate range

Embedment depth and base material thickness

Anchor size		M8	M10	M12	M16	M20	M24	M27	M30
HIT-V									
Typical embedment depth	[mm]	80	90	110	125	170	210	240	270
Base material thickness	[mm]	110	120	140	165	220	270	300	340
HIS-N									
Typical embedment depth	[mm]	90	110	125	170	205	-	-	-
Base material thickness	[mm]	120	150	170	230	270	-	-	-

Characteristic resistance

Anchor size			M8	M10	M12	M16	M20	M24	M27	M30
Non-cracked concrete										
Tension N_k	HIT-V 5.8	[kN]	18,0	29,0	42,0	70,6	111,9	153,7	187,8	216,3
	HIS-N 8.8		25,0	46,0	67,0	95,0	109,0	-	-	-
Shear V_k	HIT-V 5.8	[kN]	9,0	15,0	21,0	39,0	61,0	88,0	115,0	140,0
	HIS-N 8.8		13,0	23,0	39,0	59,0	55,0	-	-	-
Cracked concrete										
Tension N_k	HIT-V 5.8	[kN]	-	15,6	22,8	34,6	-	-	-	-
Shear V_k	HIT-V 5.8	[kN]	-	15,0	21,0	39,0	-	-	-	-

Design resistance

Anchor size			M8	M10	M12	M16	M20	M24	M27	M30
Non-cracked concrete										
Tension N_{Rd}	HIT-V 5.8	[kN]	12,0	19,3	28,0	39,2	62,2	85,4	104,3	120,2
	HIS-N 8.8		17,5	27,8	39,2	52,8	63,9	-	-	-
Shear V_{Rd}	HIT-V 5.8	[kN]	7,2	12,0	16,8	31,2	48,8	70,4	92,0	112,0
	HIS-N 8.8		10,4	18,4	26,0	39,3	36,7	-	-	-
Cracked concrete										
Tension N_{Rd}	HIT-V 5.8	[kN]	-	8,6	12,7	19,2	-	-	-	-
Shear V_{Rd}	HIT-V 5.8	[kN]	-	12,0	16,8	31,2	-	-	-	-

Recommended loads ^{a)}

Anchor size			M8	M10	M12	M16	M20	M24	M27	M30
Non-cracked concrete										
Tension N_{Rec}	HIT-V 5.8	[kN]	8,6	13,8	20,0	28,0	44,4	61,0	74,5	85,8
	HIS-N 8.8		12,5	19,8	28,0	37,7	45,6	-	-	-
Shear V_{Rec}	HIT-V 5.8	[kN]	5,1	8,6	12,0	22,3	34,9	50,3	65,7	80,0
	HIS-N 8.8		7,4	13,1	18,6	28,1	26,2	-	-	-
Cracked concrete										
Tension N_{Rec}	HIT-V 5.8	[kN]	-	6,2	9,1	13,7	-	-	-	-
Shear V_{Rec}	HIT-V 5.8	[kN]	-	8,6	12,0	22,3	-	-	-	-

a) With overall partial safety factor for action $\gamma=1,4$. The partial safety factors for action depend on the type of loading and shall be taken from national regulations.

Materials

Mechanical properties for HIT-V

Anchor size		M8	M10	M12	M16	M20	M24	M27	M30
Nominal tensile strength f_{uk}	HIT-V 5.8	500	500	500	500	500	500	500	500
	HIT-V 8.8	800	800	800	800	800	800	800	800
	HIT-V-R	700	700	700	700	700	700	500	500
	HIT-V-HCR	800	800	800	800	800	700	700	700
Yield strength f_{yk}	HIT-V 5.8	400	400	400	400	400	400	400	400
	HIT-V 8.8	640	640	640	640	640	640	640	640
	HIT-V-R	450	450	450	450	450	450	210	210
	HIT-V-HCR	640	640	640	640	640	400	400	400
Stressed cross-section A_s	HIT-V	36,6	58,0	84,3	157	245	353	459	561
Moment of resistance W	HIT-V	31,2	62,3	109	277	541	935	1387	1874

Mechanical properties for HIS-N

Anchor size		M8	M10	M12	M16	M20
Nominal tensile strength f_{uk}	HIS-N	490	490	460	460	460
	Screw 8.8	800	800	800	800	800
	HIS-RN	700	700	700	700	700
	Screw A4 - 70	700	700	700	700	700
Yield strength f_{yk}	HIS-N	410	410	375	375	375
	Screw 8.8	640	640	640	640	640
	HIS-RN	350	350	350	350	350
	Screw A4 - 70	450	450	450	450	450
Stressed cross-section A_s	HIS-(R)N	51,5	108,0	169,1	256,1	237,6
	Screw	36,6	58	84,3	157	245
Moment of resistance W	HIS-(R)N	145	430	840	1595	1543
	Screw	31,2	62,3	109	277	541

Material quality for HIT-V

Part	Material
Zinc coated steel	
Threaded rod, HIT-V 5.8 (F)	Strength class 5.8; Elongation at fracture $A_5 > 8\%$ ductile Electroplated zinc coated $\geq 5\mu\text{m}$; (F) hot dip galvanized $\geq 45\mu\text{m}$
Threaded rod, HIT-V 8.8 (F)	Strength class 8.8; Elongation at fracture $A_5 > 12\%$ ductile Electroplated zinc coated $\geq 5\mu\text{m}$; (F) hot dip galvanized $\geq 45\mu\text{m}$
Washer	Electroplated zinc coated $\geq 5\mu\text{m}$, hot dip galvanized $\geq 45\mu\text{m}$
Nut	Strength class of nut adapted to strength class of threaded rod. Electroplated zinc coated $\geq 5\mu\text{m}$, hot dip galvanized $\geq 45\mu\text{m}$
Stainless Steel	
Threaded rod, HIT-V-R	Strength class 70 for $\leq M24$ and strength class 50 for $> M24$; Elongation at fracture $A_5 > 8\%$ ductile Stainless steel 1.4401; 1.4404; 1.4578; 1.4571; 1.4439; 1.4362
Washer	Stainless steel 1.4401, 1.4404, 1.4578, 1.4571, 1.4439, 1.4362 EN 10088-1:2014
Nut	Stainless steel 1.4401, 1.4404, 1.4578, 1.4571, 1.4439, 1.4362 EN 10088-1:2014

Concrete
Chemical anchors
Mechanical anchors
Plastic/Light duty metal anchors
Insulation anchors

Material quality for HIT-V

Part	Material
High corrosion resistant steel	
Threaded rod, HIT-V-HCR	Strength class 80 for $\leq M20$ and class 70 for $> M20$, Elongation at fracture A5 $> 8\%$ ductile High corrosion resistance steel 1.4529; 1.4565;
Washer	High corrosion resistant steel 1.4529, 1.4565 EN 10088-1:2014
Nut	High corrosion resistant steel 1.4529, 1.4565 EN 10088-1:2014

Material quality for HIS-N

Part	Material	
HIS-N	Internal threaded sleeve	C-steel 1.0718 Steel galvanized $\geq 5 \mu\text{m}$
	Screw 8.8	Strength class 8.8, A5 $> 8\%$ Ductile Steel galvanized $\geq 5 \mu\text{m}$
HIS-RN	Internal threaded sleeve	Stainless steel 1.4401, 1.4571
	Screw 70	Strength class 70, A5 $> 8\%$ Ductile Stainless steel 1.4401; 1.4404, 1.4578; 1.4571; 1.4439; 1.4362

Setting information

Installation temperature range:

-10°C to +40°C

In service temperature range

Hilti HIT-HY 100 injection mortar may be applied in the temperature ranges given below. An elevated base material temperature may lead to a reduction of the design bond resistance.

Temperature range	Base material temperature	Max. long term base material temperature	Max. short term base material temperature
Temperature range I	-40 °C to + 40 °C	+ 24 °C	+ 40 °C
Temperature range II	-40 °C to + 80 °C	+ 50 °C	+ 80 °C

Max. short term base material temperature

Short term elevated base material temperatures are those that occur over brief intervals, e.g. as a result of diurnal cycling.

Max. long term base material temperature

Long term elevated base material temperatures are roughly constant over significant periods of time.

Working time and curing time

Temperature of the base material	Maximum working time t_{work}	Minimum curing time t_{cure}
$-10 \text{ °C} < T_{\text{BM}} \leq -5 \text{ °C}^{\text{a)}$	180 min	12 h
$-5 \text{ °C} < T_{\text{BM}} \leq 0 \text{ °C}$	40 min	4 h
$0 \text{ °C} < T_{\text{BM}} \leq 5 \text{ °C}$	20 min	2 h
$5 \text{ °C} < T_{\text{BM}} \leq 20 \text{ °C}$	8 min	1 h
$20 \text{ °C} < T_{\text{BM}} \leq 30 \text{ °C}$	5 min	30 min
$30 \text{ °C} < T_{\text{BM}} \leq 40 \text{ °C}$	2 min	30 min

The curing time data are valid for dry base material only. In wet base material the curing times must be doubled.

a) The foil pack temperature must be between 20°C and 25°C.

Setting details for HIT-V

Anchor size		M8	M10	M12	M16	M20	M24	M27	M30
Nominal diameter of drill bit	d_0 [mm]	10	12	14	18	22	28	30	35
Diameter of element	d [mm]	8	10	12	16	20	24	27	30
Effective anchorage and drill hole depth ^{b)}	$\frac{h_{ef,min}}{h_{ef,max}}$ [mm]	60	60	70	80	90	100	110	120
	$h_{ef,max}$ [mm]	160	200	240	320	400	480	540	600
Minimum base material thickness ^{c)}	h_{min} [mm]	$h_{ef} + 30 \geq 100$ mm			$h_{ef} + 2 d_0$				
Diameter of clearance hole in the fixture	d_f [mm]	9	12	14	18	22	26	30	33
Min. spacing	s_{min} [mm]	40	50	60	80	100	120	135	150
Min. edge distance	c_{min} [mm]	40	50	60	80	100	120	135	150
Critical spacing for splitting failure	$s_{cr,sp}$ [mm]	$2 C_{cr,sp}$							
Critical edge distance for splitting failure ^{a)}	$C_{cr,sp}$ [mm]	$1,0 \cdot h_{ef}$ for $h / h_{ef} \geq 2,0$							
		$4,6 h_{ef} - 1,8 h$ for $2,0 > h / h_{ef} > 1,3$							
		$2,26 h_{ef}$ for $h / h_{ef} \leq 1,3$							
Critical spacing for concrete cone failure	$s_{cr,N}$ [mm]	$2 C_{cr,N}$							
Critical edge distance for concrete cone failure ^{d)}	$C_{cr,N}$ [mm]	$1,5 h_{ef}$							
Torque moment ^{e)}	T_{max} [Nm]	10	20	40	80	150	200	270	300

For spacing (edge distance) smaller than critical spacing (critical edge distance) the design loads have to be reduced.

- a) both given values for drill bit diameter can be used
- b) $h_{ef,min} \leq h_{ef} \leq h_{ef,max}$ (h_{ef} : embedment depth)
- c) h : base material thickness ($h \geq h_{min}$)
- d) The critical edge distance for concrete cone failure depends on the embedment depth h_{ef} and the design bond resistance. The simplified formula given in this table is on the save side.
- e) Maximum recommended torque moment to avoid splitting failure during installation with minimum spacing and/or edge distance.

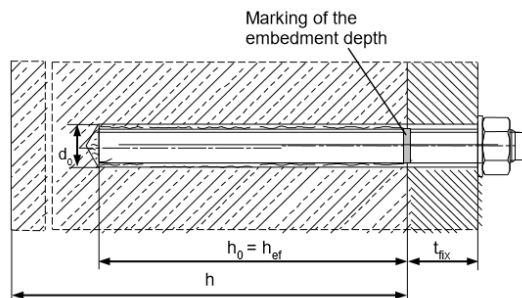
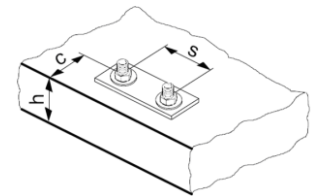

Setting details for HIS-N

Anchor size	M8	M10	M12	M16	M20
Nominal diameter of drill bit d_0 [mm]	14	18	22	28	32
Diameter of element d [mm]	12,5	16,5	20,5	25,4	27,6
Effective anchorage and drill hole depth h_{ef} [mm]	90	110	125	170	205
Minimum base material thickness h_{min} [mm]	120	150	170	230	270
Diameter of clearance hole in the fixture d_f [mm]	9	12	14	18	22
Thread engagement length min-max h_s [mm]	8-20	10-25	12-30	16-40	20-50
Min. spacing s_{min} [mm]	40	45	55	65	90
Min. edge distance c_{min} [mm]	40	45	55	65	90
Critical spacing for splitting failure $s_{cr,sp}$ [mm]	$2 C_{cr,sp}$				
Critical edge distance for splitting failure ^{a)} $c_{cr,sp}$ [mm]	$1,0 \cdot h_{ef}$		for $h / h_{ef} \geq 2,0$		
	$4,6 h_{ef} - 1,8 h$		for $2,0 > h / h_{ef} > 1,3$		
	$2,26 h_{ef}$		for $h / h_{ef} \leq 1,3$		
Critical spacing for concrete cone failure $s_{cr,N}$ [mm]	$2 C_{cr,N}$				
Critical edge distance for concrete cone failure ^{b)} $c_{cr,N}$ [mm]	$1,5 h_{ef}$				
Torque moment ^{c)} T_{max} [Nm]	10	20	40	80	150

For spacing (edge distance) smaller than critical spacing (critical edge distance) the design loads have to be reduced.



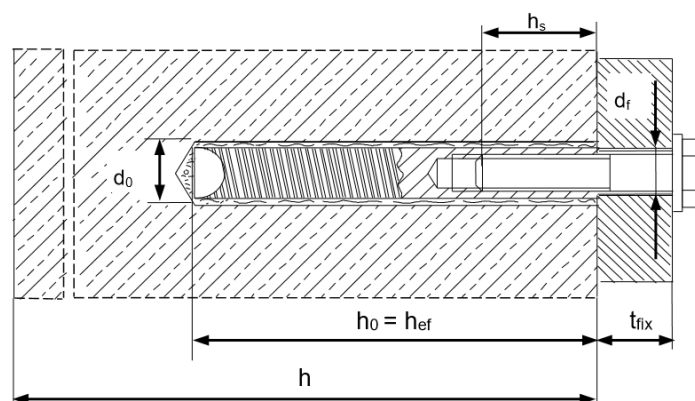
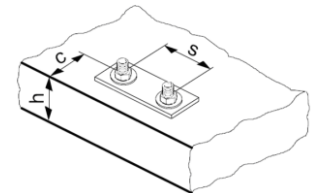

- f) both given values for drill bit diameter can be used
- g) $h_{ef,min} \leq h_{ef} \leq h_{ef,max}$ (h_{ef} : embedment depth)
- h) h : base material thickness ($h \geq h_{min}$)
- i) The critical edge distance for concrete cone failure depends on the embedment depth h_{ef} and the design bond resistance. The simplified formula given in this table is on the save side.
- j) Maximum recommended torque moment to avoid splitting failure during installation with minimum spacing and/or edge distance.



Installation equipment

Anchor size	M8	M10	M12	M16	M20	M24	M27	M30
Rotary hammer	HIT-V			TE 2 – TE 30			TE 40 – TE 80	
	HIS-N			TE 2 – TE 30			TE 40 – TE 80	
Other tools	compressed air gun or blow out pump set of cleaning brushes, dispenser							

Drilling and cleaning parameters

HIT-V	HIS-N	Hammer drill	Brush HIT-RB	Piston plug HIT-SZ
		d_0 [mm]	size [mm]	
				
M8	-	10	10	-
M10	-	12	12	12
M12	M8	14	14	14
M16	M10	18	18	18
-	M12	22	22	22
M20	-	24	24	24
M24	M16	28	28	28
M27	-	30	30	30
-	M20	32	32	32
M30	-	35	35	35

Setting instructions

*For detailed information on installation see instruction for use given with the package of the product.



Safety regulations.

Review the Material Safety Data Sheet (MSDS) before use for proper and safe handling! Wear well-fitting protective goggles and protective gloves when working with Hilti HIT-HY 100.

Drilling

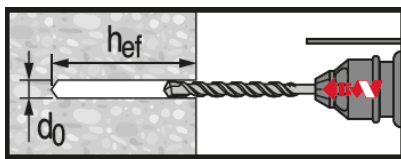

Hammer drilled hole (HD)

Cleaning

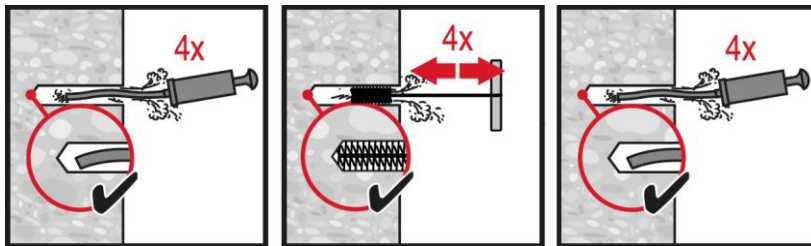

Manual cleaning (MC)

for drill diameters $d_0 \leq 18$ mm and drill hole depth $h_0 \leq 10 \cdot d_0$.

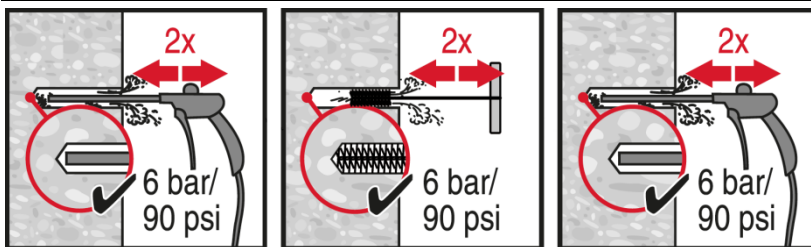

Compressed air cleaning (CAC)

for all drill hole diameters d_0 and drill hole depths h_0 .

Concrete
Chemical anchors
Mechanical anchors
Plastic/Light duty metal anchors
Insulation anchors

Injection system

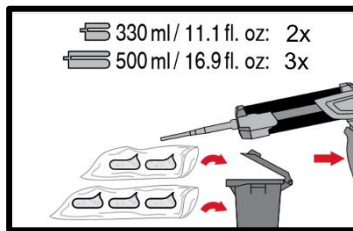
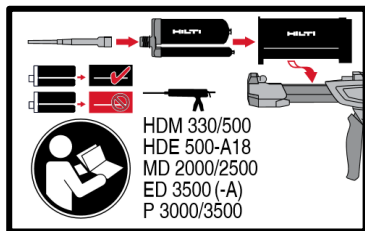

Injection system preparation.

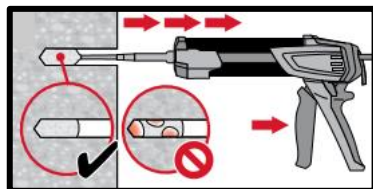
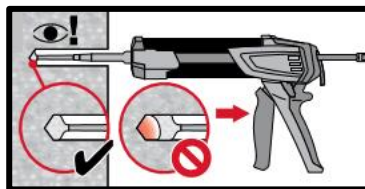

Injection method for drill hole depth
 $h_{ef} \leq 250 \text{ mm.}$

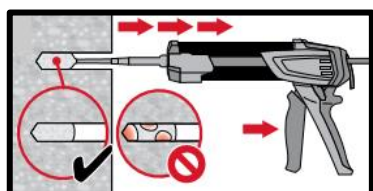
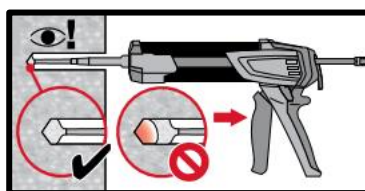

Injection method for application with
embedment depth $h_{ef} > 250 \text{ mm.}$

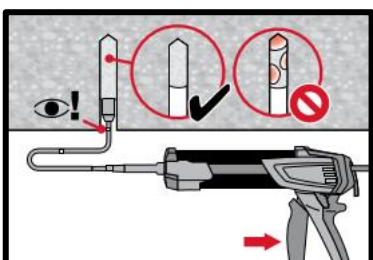
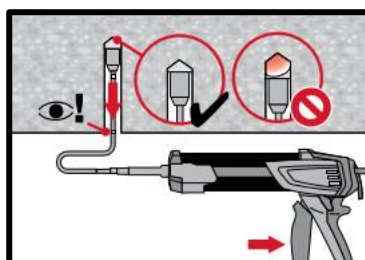

Injection method for overhead
application and/or installation with
embedment depth $h_{ef} > 250 \text{ mm.}$

Setting the element

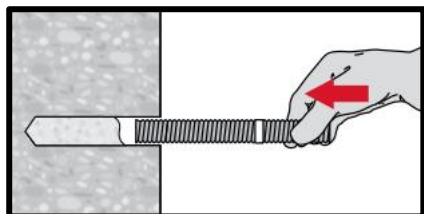

Setting element, observe working time
“ t_{work} ”,

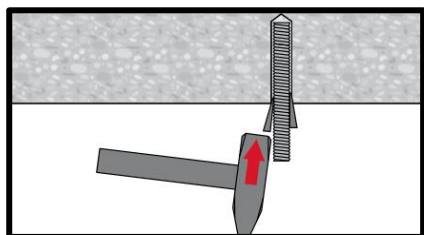

Setting element for overhead
applications, observe working time “ t_{work} ”,

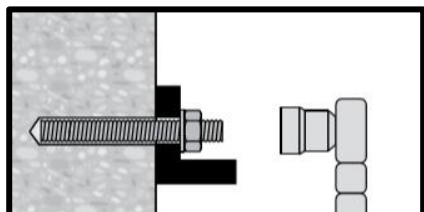

Loading the anchor: After required
curing time t_{cure} the anchor can be
loaded.

HIT-HY 100 injection mortar

Anchor design (ETAG 001) / Rebar elements / Concrete

Injection mortar system



Hilti HIT-HY 100
330 ml foil pack
(also available as
500 ml foil pack)



Rebar B500 B
($\phi 8$ - $\phi 25$)

Benefits

- Suitable for cracked and non-cracked concrete C 20/25 to C 50/60
- Suitable for dry and water saturated concrete
- Small edge distance and anchor spacing possible
- In service temperature range up to 80°C short term / 50°C long term

Base material



Concrete (non-cracked)

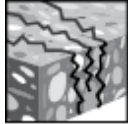

Concrete (cracked)



Dry concrete



Wet concrete

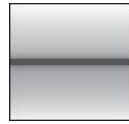

Static/
quasi-static

Load conditions

Installation conditions

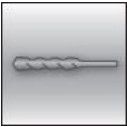

Hammer drilling

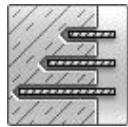

Variable embedment depth

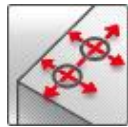

Small edge distance and spacing

Other informations



European Technical Assessment



CE conformity

Approvals / certificates

Description	Authority / Laboratory	No. / date of issue
European technical assessment ^{a)}	CSTB, Marne-la-Vallée	ETA-14/0009 / 2014-05-24

b) All data given in this section according to ETA-14/0009 issue 2014-05-24.

Static and quasi-static loading (for a single anchor)

All data in this section applies to

- Correct setting (See setting instruction)
- No edge distance and spacing influence
- Steel failure
- Base material thickness, as specified in the table
- One typical embedment depth, as specified in the table
- Anchor material: rebar B500 B
- Concrete C 20/25, $f_{ck,cube} = 25 \text{ N/mm}^2$
- Temperature range I
(min. base material temperature -40°C , max. long term/short term base material temperature: $+24^\circ\text{C}/40^\circ\text{C}$)

Embedment depth ^{a)} and base material thickness for static and quasi-static loading data

Anchor- size	$\phi 8$	$\phi 10$	$\phi 12$	$\phi 14$	$\phi 16$	$\phi 20$	$\phi 25$
Typical embedment depth [mm]	80	90	110	125	145	170	210
Base material thickness [mm]	110	120	140	165	185	220	274

a) The allowed range of embedment depth is shown in the setting details. The corresponding load values can be calculated according to the simplified design method.

Characteristic resistance

Anchor- size	$\phi 8$	$\phi 10$	$\phi 12$	$\phi 14$	$\phi 16$	$\phi 20$	$\phi 25$
Non-cracked concrete							
Tensile N_{Rk} [kN]	19,1	26,9	39,4	52,2	69,2	101,5	153,7
Shear V_{Rk} [kN]	14,0	22,0	31,0	42,0	55,0	86,0	135,0
Cracked concrete							
Tensile N_{Rk} [kN]	-	15,6	22,8	30,2	29,2	-	-
Shear V_{Rk} [kN]	-	22,0	31,0	42,0	55,0	-	-

Design resistance

Anchor- size	$\phi 8$	$\phi 10$	$\phi 12$	$\phi 14$	$\phi 16$	$\phi 20$	$\phi 25$
Non-cracked concrete							
Tensile N_{Rd} [kN]	10,6	14,9	21,9	29,0	38,5	56,4	85,4
Shear V_{Rd} [kN]	9,3	14,7	20,7	28,0	36,7	57,3	90,0
Cracked concrete							
Tensile N_{Rd} [kN]	-	8,6	12,7	16,8	16,2	-	-
Shear V_{Rd} [kN]	-	14,7	20,7	28,0	36,7	-	-

Recommended loads ^{a)}

Anchor- size	$\phi 8$	$\phi 10$	$\phi 12$	$\phi 14$	$\phi 16$	$\phi 20$	$\phi 25$
Non-cracked concrete							
Tensile N_{Rec} [kN]	7,6	10,7	15,6	20,7	27,5	40,3	61,0
Shear V_{Rec} [kN]	6,7	10,5	14,8	20,0	26,2	41,0	64,3
Cracked concrete							
Tensile N_{Rec} [kN]	-	6,2	9,1	12,0	11,6	-	-
Shear V_{Rec} [kN]	-	10,5	14,8	20,0	26,2	-	-

a) With overall partial safety factor for action $\gamma = 1,4$. The partial safety factors for action depend on the type of loading and shall be taken from national regulations.

Materials

Mechanical properties

Anchor size		φ8	φ10	φ12	φ14	φ16	φ20	φ25
Nominal tensile strength f_{uk}	[N/mm ²]	550	550	550	550	550	550	550
Yield strength f_{yk}	[N/mm ²]	500	500	500	500	500	500	500
Stressed cross-section A_s	[mm ²]	50,3	78,5	113,1	153,9	201,1	314,2	490,9
Moment of resistance W	[mm ³]	50,3	98,2	169,6	269,4	402,1	785,4	1534

Material quality

Part	Material
Rebar B500 B	EN 1992-1-1:2004 and AC:2010, Annex C Bars and de-coiled rods Class B or C with f_{yk} and k according to NDP or NCL of EN 1992-1-1/NA:2013

Setting information

Installation temperature range:

-10°C to +40°C

In service temperature range

Hilti HIT-HY 100 injection mortar may be applied in the temperature ranges given below. An elevated base material temperature may lead to a reduction of the design bond resistance.

Temperature range	Base material temperature	Max. long term base material temperature	Max. short term base material temperature
Temperature range I	-40 °C to + 40 °C	+ 24 °C	+ 40 °C
Temperature range II	-40 °C to + 80 °C	+ 50 °C	+ 80 °C

Max. short term base material temperature

Short term elevated base material temperatures are those that occur over brief intervals, e.g. as a result of diurnal cycling.

Max. long term base material temperature

Long term elevated base material temperatures are roughly constant over significant periods of time.

Working time and curing time

Temperature of the base material	Maximum working time t_{work}	Minimum curing time t_{cure}
-10 °C < T_{BM} ≤ -5 °C ^{a)}	180 min	12 h
-5 °C < T_{BM} ≤ 0 °C	40 min	4 h
0 °C < T_{BM} ≤ 5 °C	20 min	2 h
5 °C < T_{BM} ≤ 20 °C	8 min	1 h
20 °C < T_{BM} ≤ 30 °C	5 min	30 min
30 °C < T_{BM} ≤ 40 °C	2 min	30 min

The curing time data are valid for dry base material only. In wet base material the curing times must be doubled.

b) The foil pack temperature must be between 20°C and 25°C.

Setting details

Anchor size	$\phi 8$	$\phi 10$	$\phi 12$	$\phi 14$	$\phi 16$	$\phi 20$	$\phi 25$	
Nominal diameter of drill bit d_0 [mm]	12	14	16	18	20	25	32	
Effective anchorage and drill hole depth range	$h_{ef,min}$ [mm]	60	60	70	80	80	90	100
	$h_{ef,max}$ [mm]	160	200	240	280	320	400	500
Minimum base material thickness h_{min} [mm]	$h_{ef} + 30$ mm			$h_{ef} + 2 d_0$				
Min. spacing s_{min} [mm]	40	50	60	70	80	100	125	
Min. edge distance c_{min} [mm]	40	50	60	70	80	100	125	
Critical spacing for splitting failure $s_{cr,sp}$ [mm]	$2 c_{cr,sp}$							
Critical edge distance for splitting failure ^{a)} $c_{cr,sp}$ [mm]	$1,0 \cdot h_{ef}$		for $h / h_{ef} \geq 2,0$					
	$4,6 h_{ef} - 1,8 h$		for $2,0 > h / h_{ef} > 1,3$					
	$2,26 h_{ef}$		for $h / h_{ef} \leq 1,3$					
Critical spacing for concrete cone failure $s_{cr,N}$ [mm]	$2 c_{cr,N}$							
Critical edge distance for concrete cone failure ^{b)} $c_{cr,N}$ [mm]	$1,5 h_{ef}$							

For spacing (edge distance) smaller than critical spacing (critical edge distance) the design loads have to be reduced.



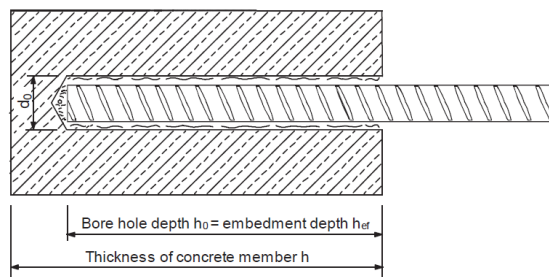
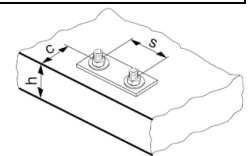

- a) h : base material thickness ($h \geq h_{min}$), h_{ef} : embedment depth
- b) The critical edge distance for concrete cone failure depends on the embedment depth h_{ef} and the design bond resistance. The simplified formula given in this table is on the safe side.



Installation equipment

Anchor size	$\phi 8$	$\phi 10$	$\phi 12$	$\phi 14$	$\phi 16$	$\phi 20$	$\phi 25$
Rotary hammer	TE 2 – TE 30					TE 40 – TE 70	
Other tools	compressed air gun or blow out pump set of cleaning brushes, dispenser						

Drilling and cleaning parameters

Rebar	Hammer drilling (HD)	Brush HIT-RB	Piston plug HIT-SZ
	d_0 [mm]	size [mm]	
			
$\phi 8$	10 / 12 ^{a)}	10 / 12 ^{a)}	- / 12
$\phi 10$	12 / 14 ^{a)}	12 / 14 ^{a)}	12 / 14 ^{a)}
$\phi 12$	14 / 16 ^{a)}	14 / 16 ^{a)}	14 / 16 ^{a)}
$\phi 14$	18	18	18
$\phi 16$	20	20	20
$\phi 20$	25	25	25
$\phi 25$	32	32	32

a) Each of the two given values can be used

Setting instructions

*For detailed information on installation see instruction for use given with the package of the product.



Safety regulations.

Review the Material Safety Data Sheet (MSDS) before use for proper and safe handling! Wear well-fitting protective goggles and protective gloves when working with Hilti HIT-HY 100.

Drilling

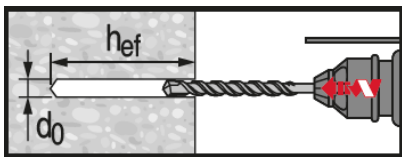

Hammer drilled hole (HD)

Cleaning

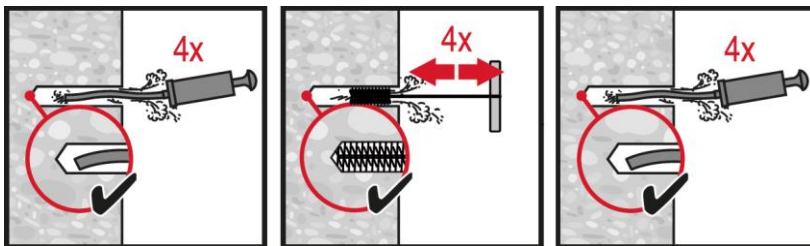

Manual cleaning (MC)

for drill diameters $d_0 \leq 18$ mm and drill hole depth $h_0 \leq 10 \cdot d_0$.

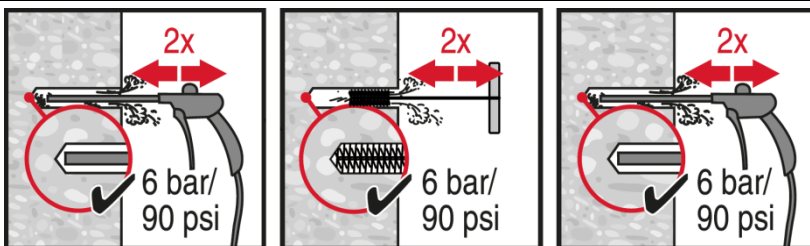

Compressed air cleaning (CAC)

for all drill hole diameters d_0 and drill hole depths h_0 .

Injection system

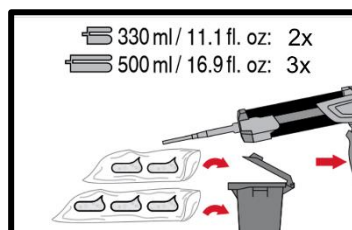
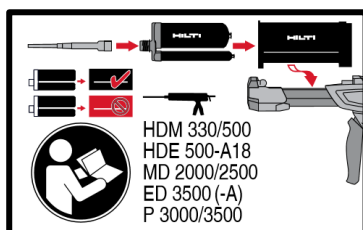

Injection system preparation.

Concrete
Chemical anchors
Mechanical anchors
Plastic/Light duty metal anchors
Insulation anchors

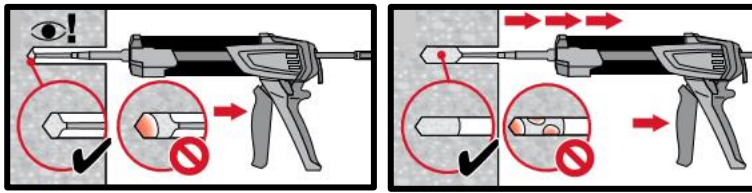

Injection method for drill hole depth $h_{ef} \leq 250$ mm.

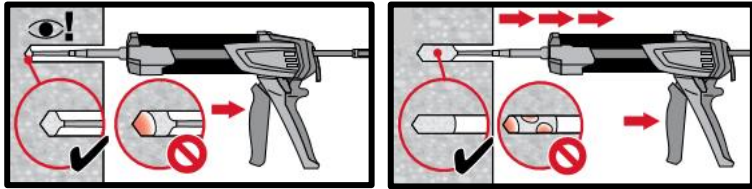

Injection method for application with embedment depth $h_{ef} > 250$ mm.

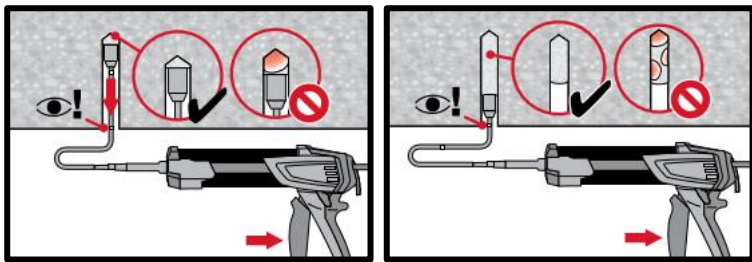

Injection method for overhead application and/or installation with embedment depth $h_{ef} > 250$ mm.

Setting the element

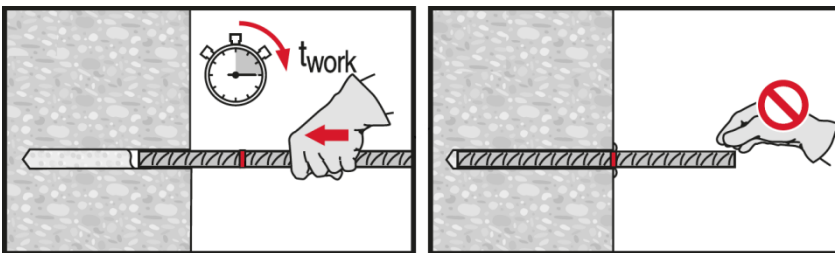

Setting element, observe working time " t_{work} ".

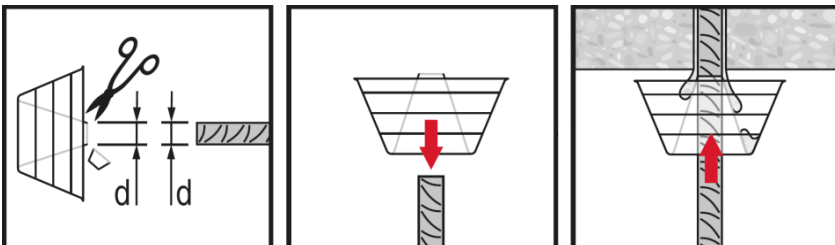

Setting element for overhead applications, observe working time " t_{work} ".

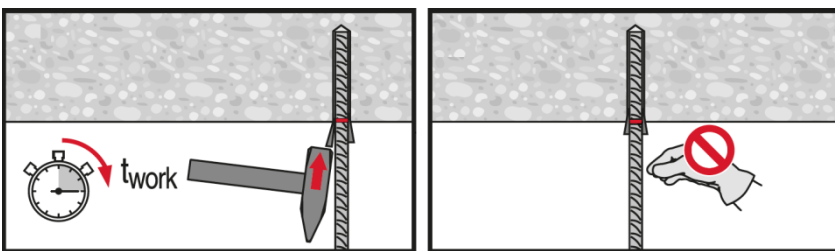

Loading the anchor: After required curing time t_{cure} the anchor can be loaded.



HIT-HY 100 injection mortar

Rebar design (EN 1992-1) / Rebar elements / Concrete

Concrete
Chemical anchors

Mechanical anchors

Plastic/Light duty metal anchors

Insulation anchors

Injection mortar system



Hilti HIT-HY 100
500 ml foil pack
(also available
as 330 ml
foil pack)



Rebar
($\phi 8$ - $\phi 25$)

Benefits

- Suitable for concrete C 12/15 to C 50/60
- High loading capacity and fast cure
- Suitable for dry and water saturated concrete
- For rebar diameters up to 25 mm
- Non corrosive to rebar elements
- Suitable for applications down to -10 °C.
- Suitable for embedment depth up to 700 mm depending on the rebar diameter

Base material



Concrete
(non-cracked)

Load conditions

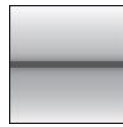

Static/
quasi-static



Fire
resistance

Installation conditions

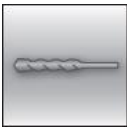

Hammer
drilled holes

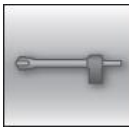

Hollow drill-
bit drilling

Other information



European
Technical
Assessment



CE
conformity

SGK

Corrosion
tested

Approvals / certificates

Description	Authority / Laboratory	No. / date of issue
European technical Approval ^{a)}	DIBt, Berlin	ETA-14/0001 / 2014-02-12
Assesment	DIBt, Berlin	I 26.1-1.21.8-22/14

a) All data given in this section according to ETA-14/0001, issue 2014-02-12.

Static and quasi-static loading

Design bond strength in N/mm² according to ETA 11/0492 for good bond conditions for hammer drilling and compressed air drilling.

Rebar (mm)	Concrete class								
	C12/15	C16/20	C20/25	C25/30	C30/37	C35/45	C40/50	C45/55	C50/60
8 – 24	1,6	2,0	2,3	2,7	3,0	3,4	3,4	3,4	3,7
25	1,6	2,0	2,3	2,7	3,0	3,4	3,7	3,7	3,7

For all other bond conditions, multiply the value by 0.7.

Anchorage length

The minimum anchorage length $\ell_{b,min}$ and the minimum lap length $\ell_{0,min}$ according to EN 1992-1-1:2004+AC:2010 ($\ell_{b,min}$ acc. to Eq. 8.6 and Eq. 8.7 and $\ell_{0,min}$ acc. to Eq. 8.11) shall be multiplied by a factor according to Table below.

Concrete class	Drilling method	Factor
C12/15 to C50/60	Hammer and compressed air drilling	1,5

Example of pre-calculated values for rebar yield strength $f_{yk} = 500 \text{ N/mm}^2$, concrete C25/30 and good bond conditions.

Rebar	Anchorage length ℓ_{bd}	Design value N_{Rd}	Mortar volume	Anchorage length ℓ_{bd}	Design value N_{Rd}	Mortar volume
[mm]	[mm]	[kN]	[ml]	[mm]	[kN]	[ml]
All $\alpha = 1$				One of the $\alpha = 0.7$		
8	150	10,2	11	150	14,5	11
	210	14,3	16	180	17,4	14
	260	17,6	20	200	19,4	15
	322	21,9	24	226	21,9	17
10	181	15,4	16	181	21,9	16
	260	22,1	24	210	25,4	19
	330	28,0	30	250	30,3	23
	403	34,2	36	281	34,1	25
12	218	22,2	23	218	31,7	23
	310	31,6	33	260	37,8	27
	390	39,7	41	300	43,6	32
	483	49,2	51	338	49,1	36
14	254	30,2	31	254	43,1	31
	360	42,8	43	300	50,9	36
	460	54,6	55	350	59,4	42
	564	67,0	68	394	66,8	48
16	290	39,4	39	290	56,2	39
	410	55,6	56	340	65,9	46
	530	71,9	72	400	77,6	54
	644	87,4	87	451	87,4	61
18	326	49,8	49	326	71,1	49
	380	58,0	57	380	82,9	57
	440	67,2	66	440	96,0	66
	500	76,3	75	500	109,1	75
20	363	61,6	77	363	88,0	77
	410	69,6	87	410	99,4	87
	450	76,3	95	450	109,1	95
	500	84,8	106	500	121,2	106

Example of pre-calculated values for rebar yield strength $f_{yk} = 500 \text{ N/mm}^2$, concrete C25/30 and good bond conditions.

Rebar [mm]	Anchorage length l_{bd} [mm]	Design value N_{Rd} [kN]	Mortar volume [ml]	Anchorage length l_{bd} [mm]	Design value N_{Rd} [kN]	Mortar volume [ml]
All $\alpha = 1$				One of the $\alpha = 0.7$		
22	399	74,5	113	399	106,4	113
	430	80,2	122	430	114,6	122
	470	87,7	133	470	125,3	133
	500	93,3	141	500	133,3	141
24	435	88,6	184	435	126,5	184
	460	93,6	194	460	133,8	194
	480	97,7	203	480	139,6	203
	500	101,8	211	500	145,4	211
25	453	96,1	170	453	137,2	170
	470	99,7	177	470	142,4	177
	480	101,8	181	480	145,4	181
	500	106,0	188	500	151,5	188

* Values corresponding to the minimum anchorage length. The maximum permissible load is valid for "good bond conditions" as described in EN 1992-1-1. For all other conditions multiply by the value by 0,7. The volume of mortar correspond to the formula " $1,2 \cdot (d_0^2 - d_s^2) \cdot \pi \cdot l_b / 4$ " for hammer drilling

Fire loading: according to DIBt Z-21.8-2024

a) Fire situation "anchorage"

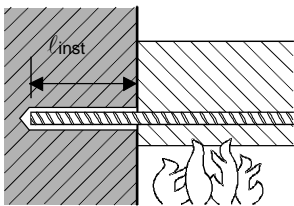

Maximum force in rebar in conjunction with HIT-HY 100 as a function of embedment depth for the fire resistance classes F30 to F180 (yield strength $f_{yk} = 500 \text{ N/mm}^2$) according to EC2.

Bar \varnothing [mm]	Max. $F_{s,T}$ [kN]	l_{inst} [mm]	Fire resistance of bar in [kN]				
			R30	R60	R90	R120	R180
8	16,19	80	3,0	0,7	0,2	0,0	0,0
		120	7,0	2,2	1,3	0,7	0,2
		170	16,2	10,2	9,2	4,0	1,7
		210		16,2	11,0	7,5	
		230	14,5		10,9		
		250	14,5		14,5		
		300	16,2	16,2			
10	25,29	100	6,1	2,0	1,0	0,4	0,0
		150	19,3	9,3	7,1	2,2	1,0
		190	25,3	18,0	15,9	9,3	4,9
		230		25,3	24,7	18,1	13,7
		260	24,7		20,3		
		280	25,3		24,7		
		320	25,3	25,3			
12	36,42	120	15,3	6,0	1,9	1,1	0,3
		180	31,0	19,0	17,8	8,5	7,0
		220	36,4	29,6	27,0	19,1	13,8
		260		36,4	29,7	24,4	
		280	35,0		29,6		
		300	36,4		34,9		
		340	36,4	36,4			

Bar Ø [mm]	Max. F _{s,T} [kN]	l _{inst} [mm]	Fire resistance of bar in [kN]				
			R30	R60	R90	R120	R180
14	49,58	140	24,0	9,9	6,9	2,6	1,0
		210	45,0	31,4	28,5	25,7	13,0
		240	49,6	40,6	37,7	32,8	22,3
		280					
		300	49,6	49,6	49,6	40,7	34,6
		330				44,7	40,7
		360				49,6	48,1
16	64,75	160	34,5	18,4	14,9	4,4	2,3
		240	62,6	46,4	43,0	37,7	25,5
		260	64,8	53,5	50,0	44,7	32,5
		300		64,8	57,0	51,7	49,6
		330			64,8	61,3	57,2
		360				64,8	62,7
		400					64,8
20	101,18	200	60,7	40,0	36,3	29,3	14,3
		250	78,3	62,5	58,3	51,3	36,3
		310	101,2	88,9	84,6	77,6	62,6
		350		101,2	101,2	94,2	80,2
		370				101,2	83,5
		390					97,8
		430					101,2
25	158,09	250	97,9	78,1	72,6	64,7	45,3
		280	126,5	94,6	89,4	81,2	61,8
		370	158,1	144,0	127,9	119,7	111,2
		410		158,1	150,0	141,8	123,2
		430			158,1	150,0	144,2
		450				158,1	155,2
		500					158,1
32	158,09	250	97,9	78,1	72,6	64,7	45,3
		280	126,5	94,6	89,4	81,2	61,8
		370	158,1	144,0	127,9	119,7	111,2
		410		158,1	150,0	141,8	123,2
		430			158,1	150,0	144,2
		450				158,1	155,2
		500					158,1

b) Fire situation “parallel”

Max. bond stress, τ_c , depending on actual clear concrete cover for classifying the fire resistance.

It must be verified that the actual force in the bar during a fire, $F_{s,T}$, can be taken up by the bar connection of the selected length, l_{inst} . Note: Cold design for ULS is mandatory.

$$F_{s,T} \leq (l_{inst} - c_f) \cdot \phi \cdot \pi \cdot \tau_c \quad \text{where: } (l_{inst} - c_f) \geq l_s;$$

l_s = lap length

ϕ = nominal diameter of bar

$l_{inst} - c_f$ = selected overlap joint length; this must be at least l_s ,

but may not be assumed to be more than 80ϕ

τ_c = bond stress when exposed to fire

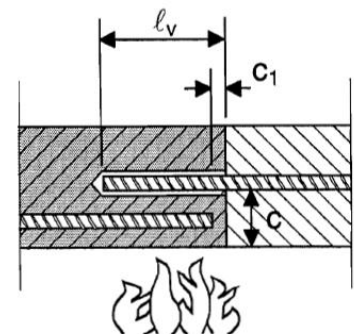

Critical temperature-dependent bond stress, τ_c , concerning “overlap joint” for Hilti HIT-HY 100 injection adhesive in relation to fire resistance class and required minimum concrete coverage c.

Clear concrete cover c [mm]	Max. bond stress, τ_c [N/mm ²]						
	R30	R60	R90	R120	R180		
30	0,6	0,3	0	0	0		
35	0,7	0,3					
40	0,9	0,4	0,2				
45	1,0	0,4	0,2				
50	1,2	0,5	0,3				
55	1,5	0,6	0,3	0,2	0		
60	1,8	0,8	0,4	0,3			
65	2,2	0,9	0,5	0,3			
70		1,0	0,5	0,3			
75		1,2	0,6	0,4		0,2	
80		1,5	0,7	0,5		0,3	
85		1,7	0,8	0,5		0,3	
90		2,0	1,0	0,6		0,3	
95		2,2	2,2	1,1		0,7	0,4
100				1,3		0,8	0,4
105				1,5	0,9	0,5	
110				1,7	1,1	0,5	
115	2,0			1,2	0,6		
120	2,2	2,2	2,2	1,4	0,6		
125				1,6	0,7		
130				1,9	0,8		
135			2,1	0,9			
200				2,3			

Materials

Material quality

Part	Material
Rebar EN 1992-1-1	Bars and de-coiled rods class B or C with f_{yk} and k according to NDP or NCL of EN 1992-1-1 $f_{uk} = f_{tk} = k \cdot f_{yk}$

Fitness for use

Some creep tests have been conducted in accordance with ETAG guideline 001 part 5 and TR 023 in the following conditions : in dry environment at 50 °C during 90 days.
These tests show an excellent behaviour of the post-installed connection made with HIT-HY 100: low displacements with long term stability, failure load after exposure above reference load.

Resistance to chemical substances

Chemical substance	Comment	Resistance
Sulphuric acid	23°C	+
Under sea water	23°C	+
Under water	23°C	+
Alkaline medium	pH = 13,2, 23°C	+

- + resistant
- o resistant in short term (max. 48h) contact
- not resistant

Curing and working time

Temperature of the base material T_{BM}	Working time $t_{work}^{a)}$	Curing time t_{cure}
$-10\text{ °C} < T_{BM} < -6\text{ °C}$	180 min	12 h
$-5\text{ °C} < T_{BM} < -1\text{ °C}$	40 min	4 h
$0\text{ °C} < T_{BM} < +4\text{ °C}$	20 min	2 h
$+5\text{ °C} < T_{BM} < +9\text{ °C}$	8 min	1 h
$+10\text{ °C} < T_{BM} < +14\text{ °C}$	7 min	50 min
$+15\text{ °C} < T_{BM} < +19\text{ °C}$	6 min	40 min
$+20\text{ °C} < T_{BM} < +24\text{ °C}$	5 min	30 min
$+25\text{ °C} < T_{BM} < +29\text{ °C}$	3 min	30 min
$+30\text{ °C} < T_{BM} \leq +40\text{ °C}$	2 min	30 min

Setting information

Installation equipment

Rebar [mm]	$\phi 8$	$\phi 10$	$\phi 12$	$\phi 14$	$\phi 16$	$\phi 18$	$\phi 20$	$\phi 22$	$\phi 24$	$\phi 25$
Rotary hammer	TE 2 – TE 40					TE 40 – TE 70				
Other tools	compressed air gun or blow out pump, set of cleaning brushes									

Drilling and cleaning diameters

Rebar [mm]	Hammer drill (HD)	Compressed air drill (CA)	Brush HIT-RB	Air nozzle HIT-RB
	d_0 [mm]		size [mm]	
$\phi 8$	12 / 10 ^{a)}	-	12 / 10 ^{a)}	12 / 10 ^{a)}
$\phi 10$	14 / 12 ^{a)}	-	14 / 12 ^{a)}	14 / 12 ^{a)}
$\phi 12$	16 / 14 ^{a)}	-	16 / 14 ^{a)}	16 / 14 ^{a)}
	-	17	18	16
$\phi 14$	18	17	18	18
	20	-	20	20
$\phi 16$	-	20	22	20
	22	22	22	22
$\phi 20$	25	-	25	25
	-	26	28	25
$\phi 22$	28	28	28	28
$\phi 24$	32	32	32	32
$\phi 25$	32	32	32	

a) Maximum installation length $l=250$ mm.

Dispensers and corresponding maximum embedment depth $l_{v,max}$

Rebar	Dispenser
	HDM 330, HDM 500, HDE 500, HIT-MD 2000, HIT-MD 2500 HIT-ED 3500, HIT-P300F, HIT-P3500F
	$l_{v,max}$ [mm]
$\phi 8 - \phi 16$	700
$\phi 18 - \phi 25$	500

Setting instructions

*For detailed information on installation see instruction for use given with the package of the product.



Safety regulations.

Review the Material Safety Data Sheet (MSDS) before use for proper and safe handling! Wear well-fitting protective goggles and protective gloves when working with Hilti HIT-HY 100.

Drilling

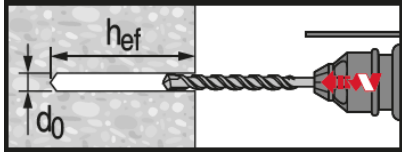

Hammer drilled hole (HD)

Cleaning

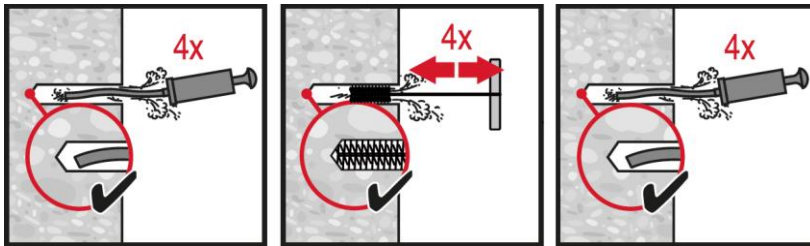

Manual cleaning (MC)

for drill diameters $d_0 \leq 18$ mm and drill hole depth $h_0 \leq 10 \cdot d_0$.

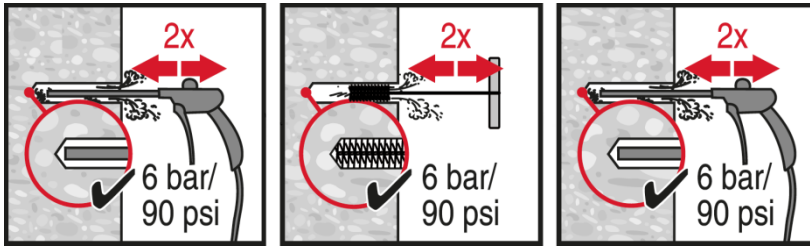

Compressed air cleaning (CAC)

for all drill hole diameters d_0 and drill hole depths h_0 .

Injection system

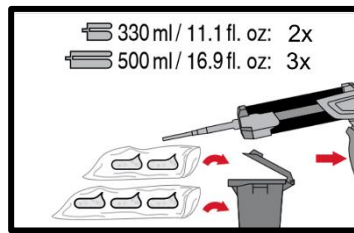
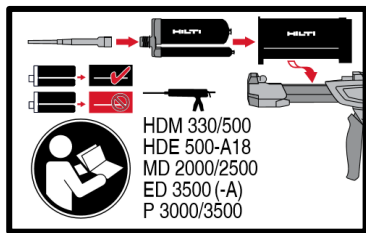

Injection system preparation.

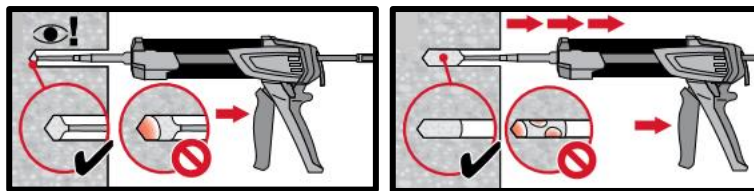

Injection method for drill hole depth $h_{ef} \leq 250$ mm.

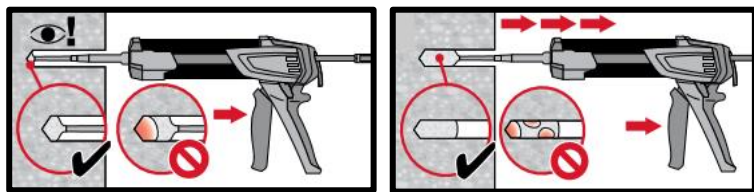

Injection method for application with embedment depth $h_{ef} > 250$ mm.

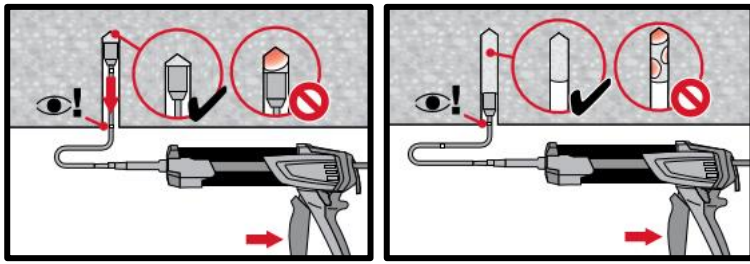

Injection method for overhead application and/or installation with embedment depth $h_{ef} > 250$ mm.

Setting the element

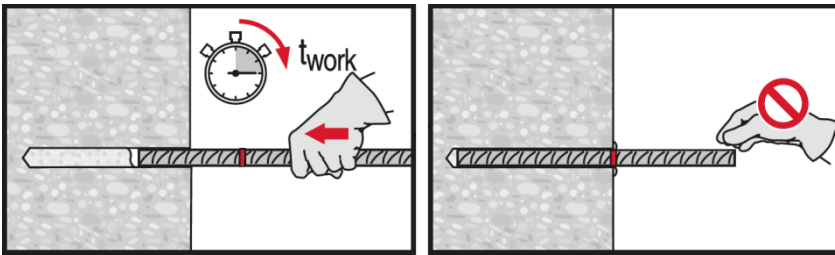

Setting element, observe working time "t_{work}".

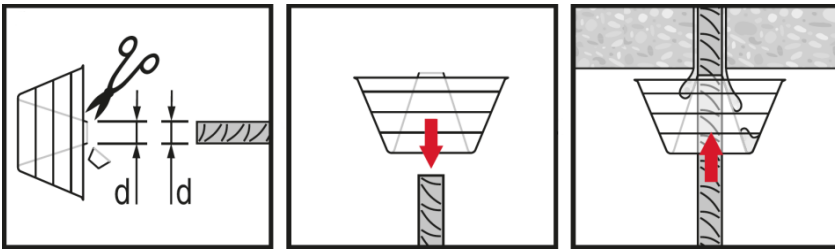

Setting element for overhead applications, observe working time "t_{work}".

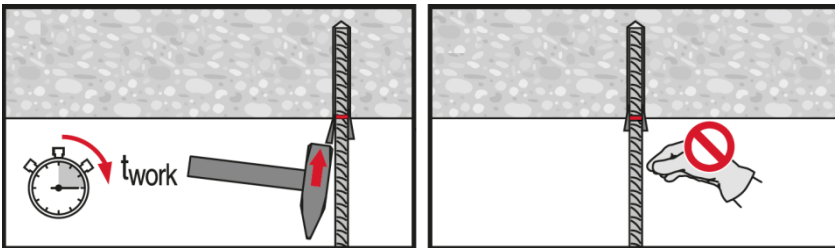

Loading the anchor: After required curing time t_{cure} the anchor can be loaded.

HIT-CT 1 injection mortar

Anchor design (ETAG 001) / Rods&Sleeves / Concrete

Injection mortar system



Hilti HIT- CT1
330 ml foil pack
(also available as
500 ml foil pack)



Anchor rods:
HIT-V
HIT-V-F
HIT-V-R
HIT-V-HCR
(M8- M24)

Benefits

- **Clean-Tec** technology: HIT-CT 1 mortar contains no hazardous labels and protects users and the environment in the event of contact with the mortar.
- **SafeSet** technology: Hilti hollow drill bit for hammer drilling
- Suitable for non-cracked concrete C20/25 to C50/60
- Suitable for dry and water saturated concrete
- High loading capacity and fast curing
- Hybrid chemistry
- Good load capacity at elevated temperatures, and suitable for applications down to -5°C

Base material



Concrete (non-cracked)



Dry concrete



Wet concrete

Load condition

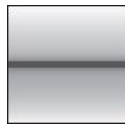

Static/
quasi-static

Installation conditions



Hammer
drilling

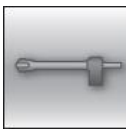

Hollow drill-
bit drilling



Hilti **SafeSet**
technology

Other information



European
Technical
Assessment



Hilti Clean
technology



CE
conformity



PROFIS
Rebar design
Software

Approvals / certificates

Description	Authority / Laboratory	No. / date of issue
European technical assessment ^{a)}	CSTB, Marne la Vallée	ETA-11/0354 / 2016-10-01

a) All data given in this section according to ETA-11/0354 issue 2016-10-01.

Static and quasi-static loading (for a single anchor)

All data in this section applies to

- Correct setting
- No edge distance and spacing influence
- Steel failure
- Base material thickness, as specified in the table
- One typical embedment depth, as specified in the table
- One anchor material, as specified in the tables
- Concrete C 20/25, $f_{ck,cube} = 25 \text{ N/mm}^2$
- Temperate range I
(min. base material temperature -40°C , max. long term/short term base material temperature: $+24^\circ\text{C}/40^\circ\text{C}$)

Embedment depth and base material thickness

Anchor- size		M8	M10	M12	M16	M20	M24
Typical embedment depth	h_{ef} [mm]	80	90	110	125	170	210
Base material thickness	h_{min} [mm]	110	120	140	161	214	266

For hammer drilled holes and Hilti hollow drill bit ^{a)}:

Characteristic resistance for HIT-V 5.8

Anchor- size		M8	M10	M12	M16	M20	M24
Tensile N_{Rk}	[kN]	18,0	29,0	42,0	62,8	101,5	142,5
Shear V_{Rk}	[kN]	9,0	15,0	21,0	39,0	61,0	88,0

a) Hilti hollow drill bit available for element size M12-M24.

Design resistance for HIT-V 5.8

Anchor- size		M8	M10	M12	M16	M20	M24
Tensile N_{Rd}	[kN]	12,0	17,3	25,3	34,9	56,4	79,2
Shear V_{Rd}	[kN]	7,2	12,0	16,8	31,2	48,8	70,4

a) Hilti hollow drill bit available for element size M12-M24.

Recommended loads ^{b)} for HIT-V 5.8

Anchor- size		M8	M10	M12	M16	M20	M24
Tensile N_{Rec}	[kN]	8,6	12,3	18,1	24,9	40,3	56,5
Shear V_{Rec}	[kN]	5,1	8,6	12,0	22,3	34,9	50,3

a) Hilti hollow drill bit available for element size M12-M24.

b) With overall partial safety factor for action $\gamma = 1,4$. The partial safety factors for action depend on the type of loading and shall be taken from national regulations.

Materials

Mechanical properties

Anchor size		M8	M10	M12	M16	M20	M24	
Nominal tensile strength f_{uk}	HIT-V 5.8	500	500	500	500	500	500	
	HIT-V 8.8	800	800	800	800	800	800	
	HIT-V-R	700	700	700	700	700	700	
	HIT-V-HCR	800	800	800	800	800	700	
Yield strength f_{yk}	HIT-V 5.8	400	400	400	400	400	400	
	HIT-V 8.8	640	640	640	640	640	640	
	HIT-V-R	450	450	450	450	450	450	
	HIT-V-HCR	600	600	600	600	600	400	
Stressed cross-section A_s	HIT-V	[mm ²]	36,6	58,0	84,3	157	245	353
Moment of resistance W	HIT-V	[mm ³]	31,2	62,3	109	277	541	935

Material quality for HIT-V

Part	Material
Zinc coated steel	
Threaded rod, HIT-V 5.8 (F)	Strength class 5.8; Elongation at fracture A5 > 8% ductile Electroplated zinc coated $\geq 5\mu\text{m}$; (F) hot dip galvanized $\geq 45\mu\text{m}$
Threaded rod, HIT-V 8.8 (F)	Strength class 8.8; Elongation at fracture A5 > 12% ductile Electroplated zinc coated $\geq 5\mu\text{m}$; (F) hot dip galvanized $\geq 45\mu\text{m}$
Hilti Meter rod, AM 8.8 (HDG)	Strength class 8.8; Elongation at fracture A5 > 12% ductile Electroplated zinc coated $\geq 5\mu\text{m}$ (HDG) hot dip galvanized $\geq 45\mu\text{m}$
Washer	Electroplated zinc coated $\geq 5\mu\text{m}$, hot dip galvanized $\geq 45\mu\text{m}$
Nut	Strength class of nut adapted to strength class of threaded rod. Electroplated zinc coated $\geq 5\mu\text{m}$, hot dip galvanized $\geq 45\mu\text{m}$
Stainless Steel	
Threaded rod, HIT-V-R	Strength class 70 for $\leq M24$ and strength class 50 for $> M24$; Elongation at fracture A5 > 8% ductile Stainless steel 1.4401; 1.4404; 1.4578; 1.4571; 1.4439; 1.4362
Washer	Stainless steel 1.4401, 1.4404, 1.4578, 1.4571, 1.4439, 1.4362 EN 10088-1:2014
Nut	Stainless steel 1.4401, 1.4404, 1.4578, 1.4571, 1.4439, 1.4362 EN 10088-1:2014
High corrosion resistant steel	
Threaded rod, HIT-V-HCR	Strength class 80 for $\leq M20$ and class 70 for $> M20$, Elongation at fracture A5 > 8% ductile High corrosion resistance steel 1.4529; 1.4565;
Washer	High corrosion resistant steel 1.4529, 1.4565 EN 10088-1:2014
Nut	High corrosion resistant steel 1.4529, 1.4565 EN 10088-1:2014

Setting information

Installation temperature:

-5°C to +40°C

Service temperature range:

Hilti HIT-CT 1 injection mortar may be applied in the temperature ranges given below. An elevated base material temperature may lead to a reduction of the design bond resistance.

Temperature range	Base material temperature	Max, long term base material temperature	Max, short term base material temperature
Temperature range I	-40 °C to + 40 °C	+ 24 °C	+ 40 °C
Temperature range II	-40 °C to + 80 °C	+ 50 °C	+ 80 °C

Max, short term base material temperature

Short term elevated base material temperatures are those that occur over brief intervals, e.g. as a result of diurnal cycling.

Max, long term base material temperature

Long term elevated base material temperatures are roughly constant over significant periods of time.

Working time and curing time

Temperature of the base material	Max, working time in which anchor can be inserted and adjusted t_{work}	Min, curing time before anchor can be fully loaded $t_{\text{cure}}^{1)}$
-5 °C < t_{BM} < 0 °C	1 hour	6 hours
0 °C $\leq t_{\text{BM}}$ < 5 °C	40 min	3 hours
5 °C $\leq t_{\text{BM}}$ < 10 °C	25 min	2 hours
10 °C $\leq t_{\text{BM}}$ < 20 °C	10 min	90 min
20 °C $\leq t_{\text{BM}}$ < 30 °C	4 min	75 min
30 °C $\leq t_{\text{BM}}$ < 40 °C	2 min	60 min

1) The curing time data are valid for dry base material only. In wet material the curing times must be doubled.

Setting details

Anchor size	M8	M10	M12	M16	M20	M24
Nominal diameter of drill bit d_0 [mm]	10	12	14	18	22	28
Effective anchorage and drill hole depth range ^{a)}	$h_{ef,min}$ [mm]	64	80	96	128	160
	$h_{ef,max}$ [mm]	96	120	144	192	240
Min. base material thickness	$h_{ef} + 30 \text{ mm} \geq 100 \text{ mm}$			$h_{ef} + 2 d_0$		
Min. spacing	s_{min} [mm]	40	50	60	80	100
Min. edge distance	c_{min} [mm]	40	50	60	80	100
Max. diameter of clearance hole in the fixture	d_f [mm]	9	12	14	18	22
Max. torque moment ^{b)}	T_{max} [Nm]	10	20	40	80	150
Critical spacing for splitting failure	$s_{cr,sp}$	$2 c_{cr,sp}$				
Critical edge distance for splitting failure ^{b)}	$c_{cr,sp}$ [mm]	$1,0 \cdot h_{ef}$ for $h / h_{ef} \geq 2,0$				
		$4,6 h_{ef} - 1,8 h$ for $2,0 > h / h_{ef} > 1,3$				
		$2,26 h_{ef}$ for $h / h_{ef} \leq 1,3$				
Critical spacing for concrete cone failure	$s_{cr,N}$	$2 c_{cr,N}$				
Critical edge distance for concrete cone failure ^{c)}	$c_{cr,N}$	$1,5 h_{ef}$				

For spacing (edge distance) smaller than critical spacing (critical edge distance) the design loads have to be reduced.

- a) $h_{ef,min} \leq h_{ef} \leq h_{ef,max}$ (h_{ef} : embedment depth)
- b) Max. recommended torque moment to avoid splitting failure during installation with min. spacing and/or edge distance
- c) h : base material thickness ($h \geq h_{min}$)
- d) The critical edge distance for concrete cone failure depends on the embedment depth h_{ef} and the design bond resistance. The simplified formula given in this table is on the save side.

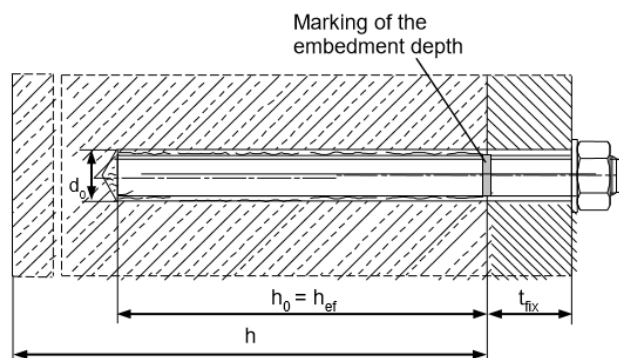
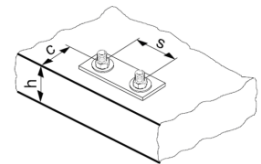

Installation equipment

Anchor size	M8	M10	M12	M16	M20	M24
Rotary hammer	TE 2 (-A) – TE 16 (-A)				TE 40 – TE 80	
Other tools	Compressed air gun, blow out pump Set of cleaning brushes, dispenser					

Drilling and cleaning parameters

HIT-V	Hammer drill (HD)	Hollow Drill Bit (HDB)	Brush HIT-RB	Air nozzle HIT-RB
	d ₀ [mm]		size [mm]	
M8	10	-	10	-
M10	12	-	12	12
M12	14	14	14	14
M16	18	18	18	18
M20	22	22	22	22
M24	28	28	28	28

Setting instructions

*For detailed information on installation see instruction for use given with the package of the product.



Safety regulations,

Review the Material Safety Data Sheet (MSDS) before use for proper and safe handling! Wear well-fitting protective goggles and protective gloves when working with Hilti HIT-CT1.

Drilling

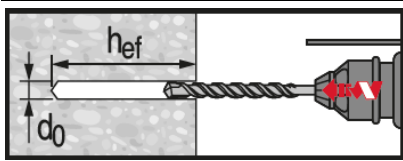

Hammer drilled hole (HD)

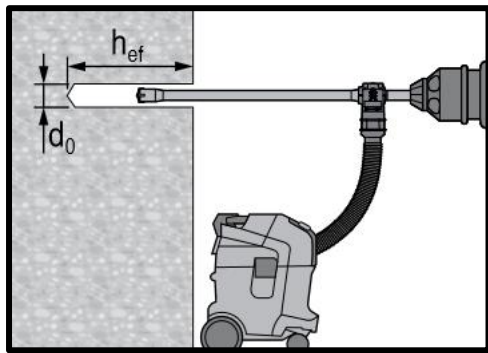

Hammer drilled hole with Hollow drill bit (HDB)

No cleaning required

Cleaning

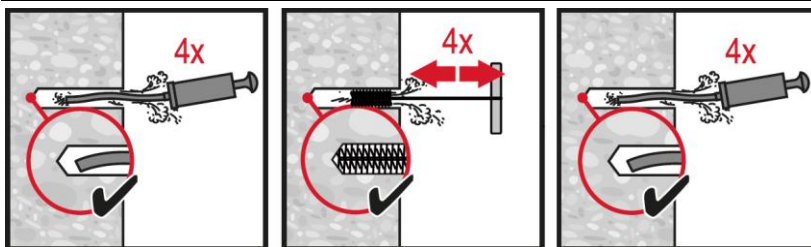

Manual cleaning (MC)

for drill diameters $d_0 \leq 20$ mm and drill hole depth $h_0 \leq 10 \cdot d$.

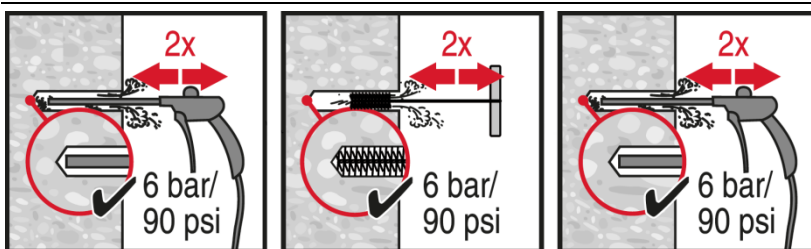

Compressed air cleaning (CAC)

for all drill hole diameters d_0 and drill hole depths $h_0 \leq 20 \cdot d$.

Injection

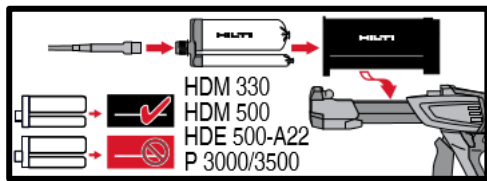

Injection system preparation

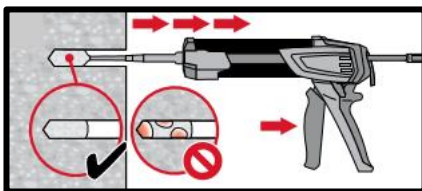
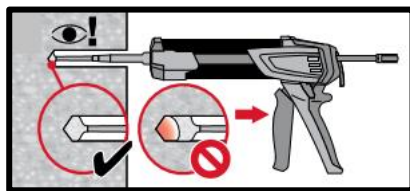
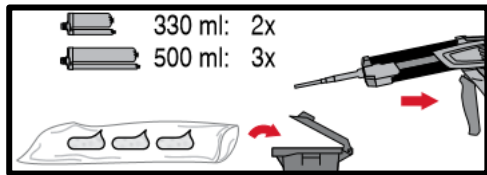

Injection method for drill hole depth $h_{ef} \leq 250$ mm.

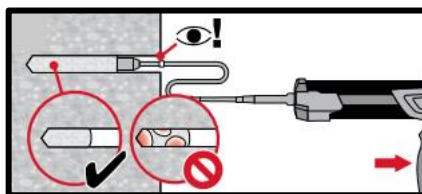
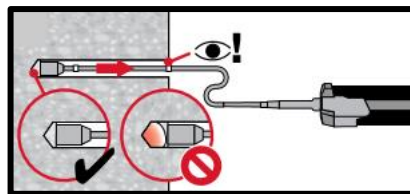

Injection method for drill hole depth $h_{ef} > 250$ mm.

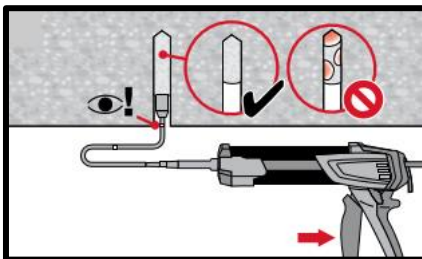
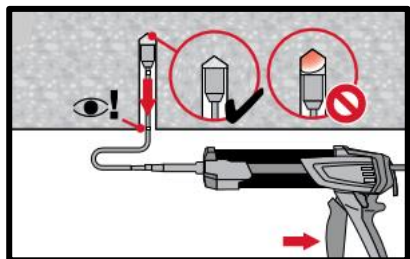

Injection method for overhead application

Setting the element

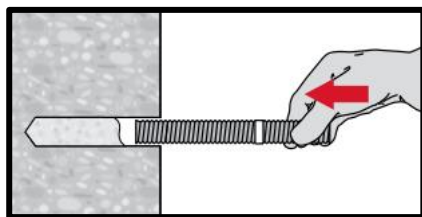

Setting element, observe working time " t_{work} ".

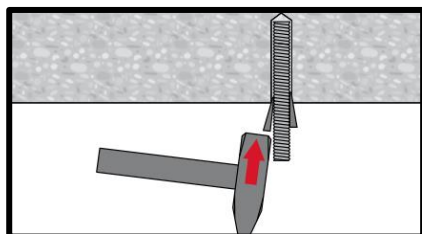

Setting element for overhead applications, observe working time " t_{work} ".

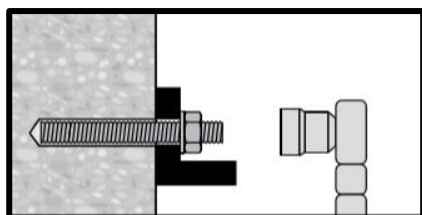

Loading the anchor: After required curing time t_{cure} the anchor can be loaded.

HIT-CT 1 injection mortar

Anchor design (ETAG 001) / Rebar elements / Concrete

Injection mortar system



Hilti HIT- CT1
330 ml foil pack
(also available as
500 ml foil pack)



Rebar B500 B
($\phi 8$ - $\phi 25$)

Benefits

- **Clean-Tec** technology: HIT-CT 1 mortar contains no hazardous labels and protects users and the environment in the event of contact with the mortar.
- **SafeSet** technology: Hilti hollow drill bit for hammer drilling
- Suitable for non-cracked concrete C20/25 to C50/60
- Suitable for dry and water saturated concrete
- High loading capacity and fast curing
- Hybrid chemistry
- Good load capacity at elevated temperatures, and suitable for applications down to -5°C

Base material



Concrete (non-cracked)



Dry concrete



Wet concrete

Load condition

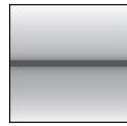

Static/
quasi-static

Installation conditions



Hammer
drilling

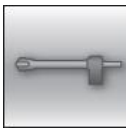

Hollow drill-
bit drilling



Hilti **SafeSet**
technology

Other information



European
Technical
Assessment



Hilti Clean
technology



CE
conformity



PROFIS
Rebar design
Software

Approvals / certificates

Description	Authority / Laboratory	No. / date of issue
European technical assessment ^{a)}	CSTB, Marne la Vallée	ETA-11/0354 / 2016-10-01

b) All data given in this section according to ETA-11/0354 issue 2016-10-01.

Static and quasi-static loading (for a single anchor)

All data in this section applies to

- Correct setting
- No edge distance and spacing influence
- Steel failure
- Base material thickness, as specified in the table
- One typical embedment depth, as specified in the table
- Anchor material: rebar B500 B
- Concrete C 20/25, $f_{ck,cube} = 25 \text{ N/mm}^2$
- Temperature range I
(min. base material temperature -40°C , max. long term/short term base material temperature: $+24^\circ\text{C}/40^\circ\text{C}$)

Embedment depth and base material thickness for static and quasi-static loading data

Anchor- size	$\phi 8$	$\phi 10$	$\phi 12$	$\phi 14$	$\phi 16$	$\phi 20$	$\phi 25$
Typical embedment depth [mm]	80	90	110	125	125	170	210
Base material thickness [mm]	110	120	142	161	165	220	274

For hammer drilled holes and Hilti hollow drill bit^{a)}:

Characteristic resistance

Anchor- size	$\phi 8$	$\phi 10$	$\phi 12$	$\phi 14$	$\phi 16$	$\phi 20$	$\phi 25$
Tensile N_{Rk}	14,1	21,2	31,1	41,2	47,1	85,5	131,9
Shear V_{Rk} [kN]	14,0	22,0	31,0	42,0	55,0	86,0	135,0

a) Hilti hollow drill bit available for element size M12-M25.

Design resistance

Anchor- size	$\phi 8$	$\phi 10$	$\phi 12$	$\phi 14$	$\phi 16$	$\phi 20$	$\phi 25$
Tensile N_{Rd}	7,8	11,8	17,3	22,9	26,2	47,5	73,3
Shear V_{Rd} [kN]	9,3	14,7	20,7	28,0	36,7	57,3	90,0

1) Hilti hollow drill bit available for element size M12-M25.

Recommended loads^{b)}

Anchor- size	$\phi 8$	$\phi 10$	$\phi 12$	$\phi 14$	$\phi 16$	$\phi 20$	$\phi 25$
Tensile N_{Rec}	5,6	8,4	12,3	16,4	18,7	33,9	52,4
Shear V_{Rec} [kN]	6,7	10,5	14,8	20,0	26,2	41,0	64,3

a) Hilti hollow drill bit available for element size M12-M25.

b) With overall partial safety factor for action $\gamma = 1,4$. The partial safety factors for action depend on the type of loading and shall be taken from national regulations.

Materials

Mechanical properties

Anchor size		φ8	φ10	φ12	φ14	φ16	φ20	φ25
Nominal tensile strength f_{uk} [N/mm ²]		550	550	550	550	550	550	550
Yield strength f_{yk} [N/mm ²]		500	500	500	500	500	500	500
Stressed cross-section A_s [mm ²]		50,3	78,5	113,1	153,9	201,1	314,2	490,9
Moment of resistance W [mm ³]		50,3	98,2	169,6	269,4	402,1	785,4	1534

Material quality

Part	Material
Rebar B500 B	EN 1992-1-1:2004 and AC:2010, Annex C Bars and de-coiled rods Class B or C with f_{yk} and k according to NDP or NCL of EN 1992-1-1/NA:2013

Setting information

Installation temperature:

-5°C to +40°C

Service temperature range:

Hilti HIT-CT 1 injection mortar may be applied in the temperature ranges given below. An elevated base material temperature may lead to a reduction of the design bond resistance.

Temperature range	Base material temperature	Max, long term base material temperature	Max, short term base material temperature
Temperature range I	-40 °C to + 40 °C	+ 24 °C	+ 40 °C
Temperature range II	-40 °C to + 80 °C	+ 50 °C	+ 80 °C

Max, short term base material temperature

Short term elevated base material temperatures are those that occur over brief intervals, e.g. as a result of diurnal cycling.

Max, long term base material temperature

Long term elevated base material temperatures are roughly constant over significant periods of time.

Working time and curing time

Temperature of the base material	Max, working time in which anchor can be inserted and adjusted t_{work}	Min, curing time before anchor can be fully loaded $t_{cure}^{1)}$
-5 °C < t_{BM} < 0 °C	1 hour	6 hours
0 °C ≤ t_{BM} < 5 °C	40 min	3 hours
5 °C ≤ t_{BM} < 10 °C	25 min	2 hours
10 °C ≤ t_{BM} < 20 °C	10 min	90 min
20 °C ≤ t_{BM} < 30 °C	4 min	75 min
30 °C ≤ t_{BM} < 40 °C	2 min	60 min

2) The curing time data are valid for dry base material only. In wet material the curing times must be doubled.

Setting details

Anchor size		φ8	φ10	φ12	φ14	φ16	φ20	φ25
Nominal diameter of drill bit	d_0 [mm]	10 / 12 ^{a)}	12 / 14 ^{a)}	14 ^{a)} / 16 ^{a)}	18	20	25	32
Effective anchorage and drill hole depth range	$h_{ef,min}$ [mm]	64	80	96	112	128	160	200
	$h_{ef,max}$ [mm]	96	120	144	168	192	240	300
Minimum base material thickness	h_{min} [mm]	$h_{ef} + 30 \text{ mm}$ $\geq 100 \text{ mm}$			$h_{ef} + 2 d_0$			
Min. spacing	s_{min} [mm]	40	50	60	70	80	100	125
Min. edge distance	c_{min} [mm]	40	50	60	70	80	100	125
Critical spacing for splitting failure	$s_{cr,sp}$ [mm]	$2 c_{cr,sp}$						
Critical edge distance for splitting failure ^{b)}	$c_{cr,sp}$ [mm]	$1,0 \cdot h_{ef}$		for $h / h_{ef} \geq 2,0$				
		$4,6 h_{ef} - 1,8 h$		for $2,0 > h / h_{ef} > 1,3$				
		$2,26 h_{ef}$		for $h / h_{ef} \leq 1,3$				
Critical spacing for concrete cone failure	$s_{cr,N}$ [mm]	$3,0 h_{ef}$						
Critical edge distance for concrete cone failure ^{c)}	$c_{cr,N}$ [mm]	$1,5 h_{ef}$						

For spacing (edge distance) smaller than critical spacing (critical edge distance) the design loads have to be reduced.

- a) Both given values for drill bit diameter can be used
- b) h : base material thickness ($h \geq h_{min}$), h_{ef} : embedment depth
- c) The critical edge distance for concrete cone failure depends on the embedment depth h_{ef} and the design bond resistance. The simplified formula given in this table is on the safe side.

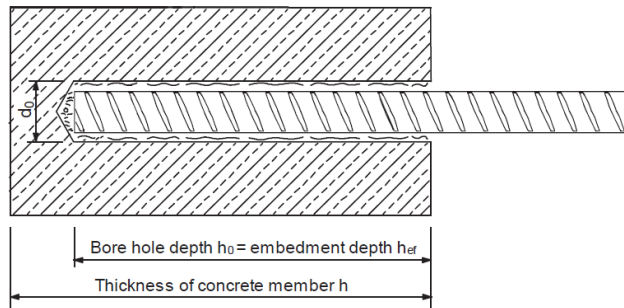
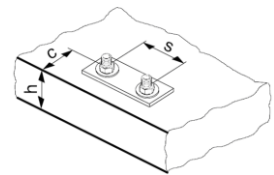

Installation equipment

Anchor size	φ8	φ10	φ12	φ14	φ16	φ20	φ25
Rotary hammer	TE 2 – TE 30					TE 40 – TE 80	
Other tools	compressed air gun or blow out pump set of cleaning brushes, dispenser						

Drilling and cleaning parameters

Rebar	Hammer drilling (HD)	Hollow Drill Bit (HDB)	Brush HIT-RB	Piston plug HIT-SZ
	d_0 [mm]		size [mm]	
$\phi 8$	10 / 12 ^{a)}	-	10 / 12 ^{a)}	- / 12
$\phi 10$	12 / 14 ^{a)}	14	12 / 14 ^{a)}	12 / 14 ^{a)}
$\phi 12$	14 / 16 ^{a)}	16 (14 ^{a)})	14 / 16 ^{a)}	14 / 16 ^{a)}
$\phi 14$	18	18	18	18
$\phi 16$	20	20	20	20
$\phi 20$	25	25	25	25
$\phi 25$	32	32	32	32

a) Each of the two given values can be used

Setting instructions

*For detailed information on installation see instruction for use given with the package of the product.



Safety regulations,

Review the Material Safety Data Sheet (MSDS) before use for proper and safe handling! Wear well-fitting protective goggles and protective gloves when working with Hilti HIT-CT1.

Drilling

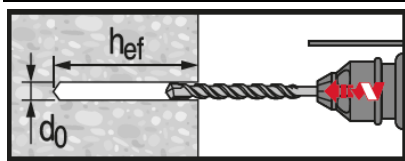

Hammer drilled hole (HD)

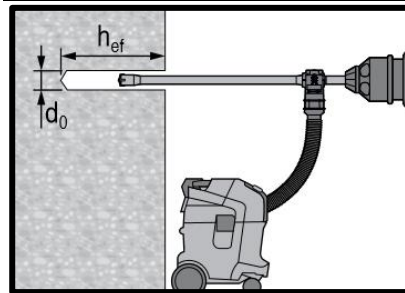

Hammer drilled hole with Hollow drill bit (HDB)

No cleaning required

Cleaning

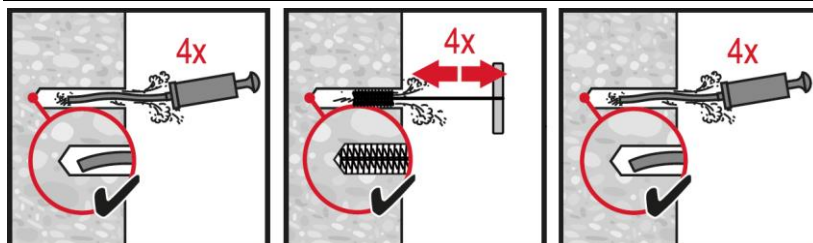

Manual cleaning (MC)

for drill diameters $d_0 \leq 20$ mm and drill hole depth $h_0 \leq 10 \cdot d$.

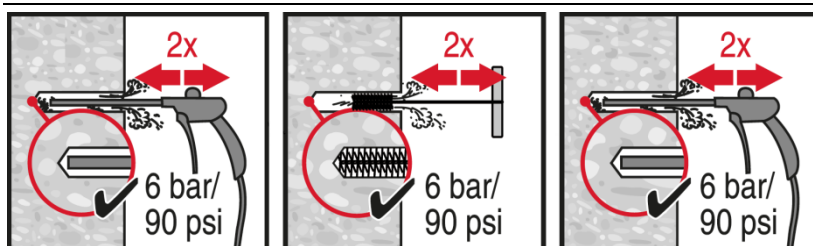

Compressed air cleaning (CAC)

for all drill hole diameters d_0 and drill hole depths $h_0 \leq 20 \cdot d$.

Injection

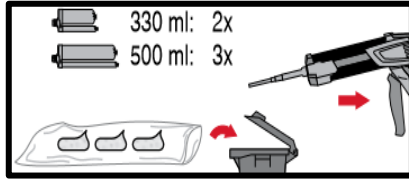
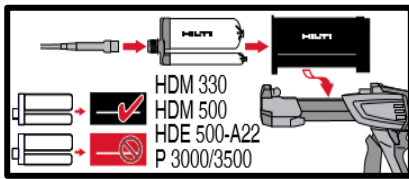

Injection system preparation

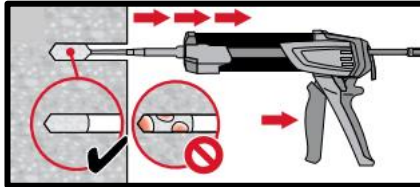
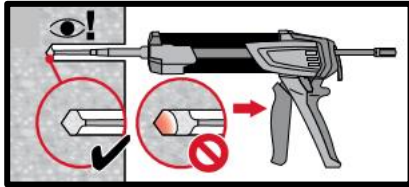

Injection method for drill hole depth
 $h_{ef} \leq 250$ mm.

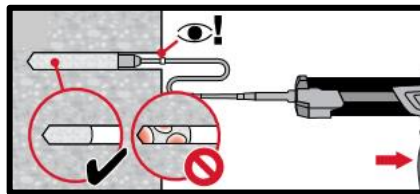
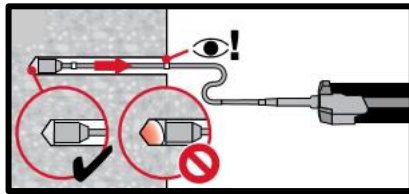

Injection method for drill hole depth
 $h_{ef} > 250$ mm.

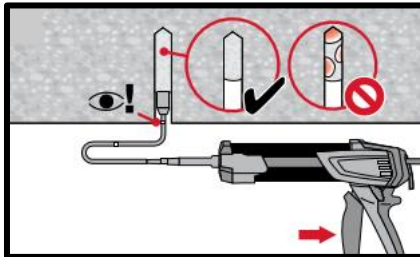
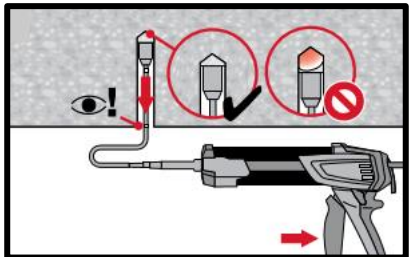

Injection method for overhead
application

Setting the element

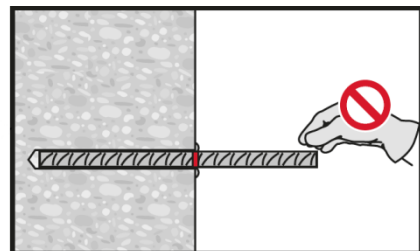
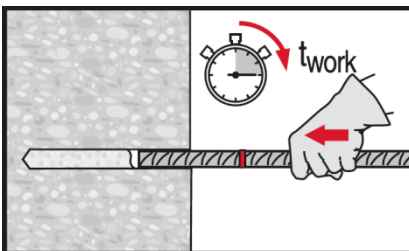

Setting element, observe working time
“ t_{work} ”.

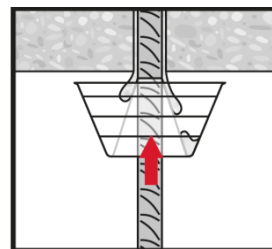
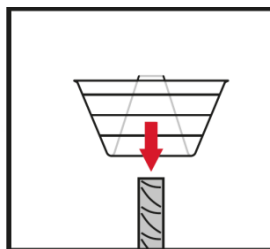
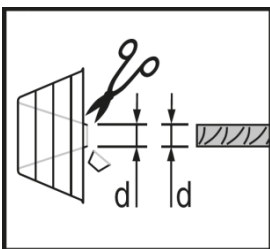

Setting element for overhead
applications, observe working time “ t_{work} ”.

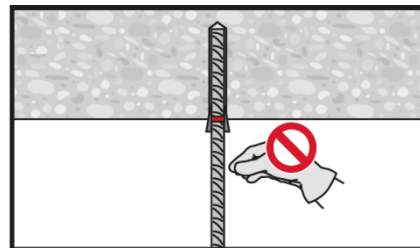
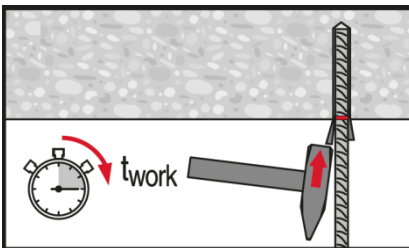

Loading the anchor: After required
curing time t_{cure} the anchor can be
loaded.

HIT-CT 1 injection mortar

Rebar design (EN 1992-1) / Rebar elements / Concrete



Concrete





Chemical anchors







Mechanical anchors

Plastic/Light duty metal anchors

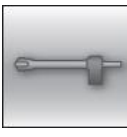
Insulation anchors

Injection mortar system	Benefits
 <p>Hilti HIT- CT1 330 ml foil pack (also available as 500 ml foil pack)</p>	<ul style="list-style-type: none"> - Clean-Tec technology: HIT-CT 1 mortar contains no hazardous labels and protects users and the environment in the event of contact with the mortar. - SafeSet technology: Hilti hollow drill bit for hammer drilling - Suitable for concrete C12/15 to C50/60 - Suitable for dry or wet concrete - High loading capacity and fast curing - Hybrid chemistry - Suitable for dry and water saturated concrete - For rebar diameters up to 25 mm - Non-corrosive to rebar elements
 <p>Rebar B500 B ($\phi 8 - \phi 25$)</p>	

Base material	Load conditions
 Concrete (non-cracked)  Dry concrete  Wet concrete	 Static/quasi-static  Fire resistance

Installation conditions	Other information
 Hammer drilled holes  Hollow drill-bit drilling	 Hilti SafeSet technology with hollow drill bit  European Technical Assessment  Hilti Clean technology  CE conformity  PROFIS Rebar design software

Approvals / certificates

Description	Authority / Laboratory	No. / date of issue
European Technical Assessment ^{a)}	CSTB, Marne la Vallée	ETA-11/0390 / 2016-11-01
Fire report	CSTB, Marne la Vallée	n° 26059386 / 2015-10-23

c) All data given in this section according to the approvals mentioned above ETA-11/0390 issue 2016-11-01

Static and quasi-static loading

Static EC2 design

Design bond strength in N/mm² accord. to ETA 11/0390 for good bond conditions

All allowed drilling methods									
Rebar - size	Concrete class								
	C12/15	C16/20	C20/25	C25/30	C30/37	C35/45	C40/50	C45/55	C50/60
φ8 - φ25	1,6	2,0	2,3	2,7	3,0	3,0	3,0	3,0	3,0

For poor bond conditions multiply the values by 0,7. Values valid for non-cracked and cracked concrete

Minimum anchorage length and minimum lap length

The minimum anchorage length $\ell_{b,min}$ and the minimum lap length $\ell_{0,min}$ according to EN 1992-1-1 shall be multiplied by relevant **Amplification factor** α_{lb} in the table below.

Amplification factor α_{lb} for the min. anchorage length and min. lap length according to EN 1992-1-1 for:

All allowed drilling methods									
Rebar - size	Concrete class								
	C12/15	C16/20	C20/25	C25/30	C30/37	C35/45	C40/50	C45/55	C50/60
φ8 - φ25	1,0			1,2	1,4				

Anchorage length for characteristic steel strength $f_{yk}=500$ N/mm² for good conditions

All allowed drilling methods								
Size	$f_{y,k}$ [N/mm ²]	$\ell_{b,min}^*$ [mm]			$\ell_{0,min}^*$ [mm]			ℓ_{max} [mm]
		C20/25	C25/30	C30/37- C50/60	C20/25	C25/30	C30/37- C50/60	
φ8	500	113	120	140	200	240	280	700
φ10	500	142	145	152	200	240	280	700
φ12	500	170	174	183	200	240	280	700
φ14	500	199	203	213	210	252	294	700
φ16	500	227	232	244	240	288	336	700
φ18	500	255	261	274	270	324	378	500
φ20	500	284	290	305	300	360	420	500
φ22	500	312	319	335	330	396	462	500
φ24	500	340	348	365	360	432	-	500
φ25	500	355	363	381	375	450	-	500

According to EN 1992-1-1 $\ell_{b,min}$ (8.6) are calculated for good bond conditions with maximum yield strength $f_{yk}=1,15$ and $\alpha_6 = 1,0$

Temperature reduction factor $k_{fi}(\theta)$

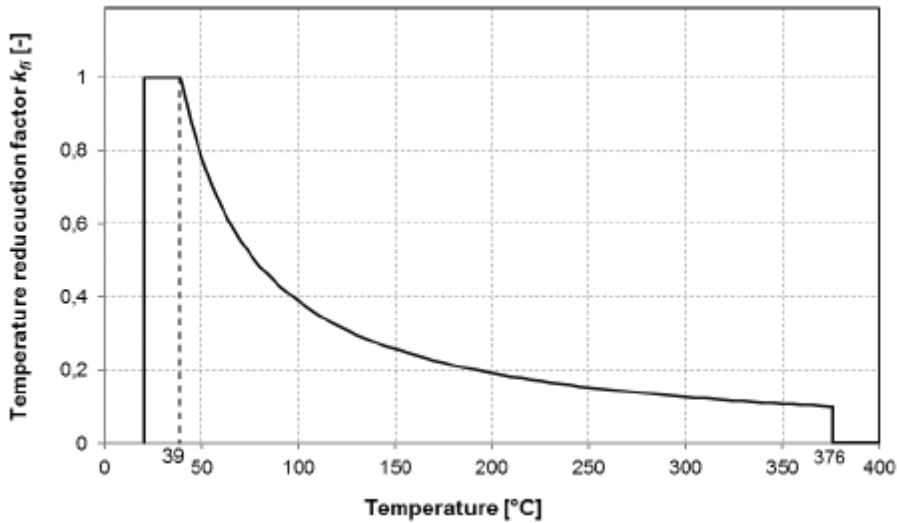

The analytic equation that describe the variation of $k_{fi}(\theta)$ with temperature is given by the following function:

If $39^\circ\text{C} \leq \theta \leq 376^\circ\text{C}$: $k_{fi}(\theta) = 41,001 \times \theta^{-1,012} \leq 1,0$ θ in $^\circ\text{C}$
 If $\theta < 39^\circ\text{C}$ $k_{fi}(\theta) = 1.0$
 If $\theta > 376^\circ\text{C}$ $k_{fi}(\theta) = 0.0$

The design value of ultimate bond strength $f_{bd,fi}$ under fire exposure is calculated according to following equation:

$$f_{bd,fi} = k_{fi}(\theta) \cdot f_{bd} \cdot \gamma_c / \gamma_{M,fi}$$

With:

- $k_{fi}(\theta)$ temperature reduction factor under fire exposure.
- f_{bd} design values of the ultimate bond resistance according to amplification factor α_{lb}
- $\gamma_c = 1,5$ recommended safety factor according to EN 1992-1-1.
- $\gamma_{M,fi}$ safety factor according to EN 1992-1-2 under fire exposure.

a) Anchoring application

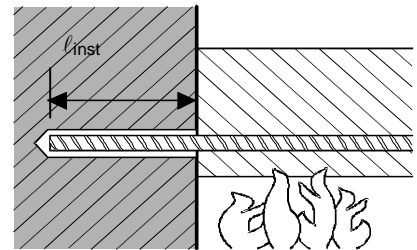

Anchoring application beam-wall connections with a concrete cover of 20 mm

Maximum force ($F_{s,T,max}$) in rebar in conjunction with HIT-CT 1 as a function of embedment depth (l_{inst}) for the fire resistance classes F30 to F240 according to EC2.

Rebar-size	$F_{s,T,max}$ [kN]	l_{inst} [mm]	Fire resistance of bar [kN]					
			R30	R60	R90	R120	R180	R240
$\phi 8$	16,8	100	4,0	2,0	1,2	0,9	0,5	0,3
		140	7,4	4,7	3,0	2,3	1,5	1,1
		180	10,9	8,2	6,1	4,6	3,0	2,2
		220	14,4	11,7	9,5	7,9	5,3	3,9
		250	16,8	14,3	12,1	10,5	7,6	5,6
		280		16,8	14,7	13,1	10,2	7,9
		310	16,8		16,8	16,8	15,7	12,8
		330		16,8			16,8	16,8
		360	16,8		16,8	16,8		
		390		16,8			16,8	16,8

Maximum force ($F_{s,T,max}$) in rebar in conjunction with HIT-CT 1 as a function of embedment depth (l_{inst}) for the fire resistance classes F30 to F240 according to EC2.

Rebar-size	$F_{s,T,max}$ [kN]	l_{inst} [mm]	Fire resistance of bar [kN]						
			R30	R60	R90	R120	R180	R240	
φ10	26,2	110	6,0	3,1	2,0	1,5	0,9	0,6	
		150	10,4	7,0	4,6	3,5	2,2	1,6	
		190	14,7	11,3	8,7	6,7	4,3	3,2	
		230	19,0	15,7	13,0	10,9	7,5	5,6	
		300	26,2	26,2	23,3	20,6	18,5	14,9	12,0
		330			23,8	21,8	18,2	15,2	
		360			26,2	25,0	21,4	18,5	
		380				23,6	20,6		
		410				23,9			
440	26,2								
φ12	37,7	140	11,1	7,1	4,5	3,5	2,2	1,6	
		200	18,9	14,9	11,7	9,2	6,0	4,5	
		260	26,7	22,7	19,5	17,0	12,7	9,5	
		320	34,6	30,5	27,3	24,8	20,5	17,0	
		350	37,7	37,7	34,4	31,2	28,7	24,4	20,9
		380			35,1	32,6	28,3	24,8	
		400			37,7	35,3	30,9	27,4	
		420				33,5	30,0		
		460				35,2			
		480	37,7						
		φ14	51,3	160	16,0	11,3	7,7	5,8	3,7
220	25,1			20,4	16,7	13,8	9,2	6,9	
280	34,2			29,5	25,8	22,9	17,9	13,8	
340	43,3			38,6	34,9	32,0	27,0	22,8	
400	51,3			51,3	47,7	44,0	41,1	36,1	31,9
430					48,5	45,7	40,6	36,5	
450					51,3	48,7	43,7	39,5	
470						46,7	42,6		
510						48,6			
530	51,3								
φ16	67,0			180	21,8	16,4	12,1	9,1	6,0
		240	32,2	26,8	22,5	19,3	13,5	10,0	
		300	42,6	37,2	32,9	29,7	23,9	19,2	
		360	53,0	47,6	43,3	40,1	34,3	29,6	
		450	67,0	67,0	63,2	58,9	55,7	49,9	45,2
		480			64,1	60,9	55,1	50,4	
		500			67,0	64,3	58,6	53,8	
		520				62,0	57,3		
		550				62,5			
		580	67,0						
		φ20	104,7	220	35,9	29,2	23,8	19,7	13,1
280	48,9			42,2	36,8	32,7	25,5	19,7	
340	61,9			55,2	49,8	45,7	38,5	32,6	
400	74,9			68,2	62,8	58,8	51,5	45,6	
460	87,9			81,2	75,8	71,8	64,5	58,6	
540	104,7			104,7	98,5	93,2	89,1	81,9	76,0
570					99,7	95,6	88,4	82,5	
600					104,7	102,1	94,9	89,0	
620						99,2	93,3		
650						99,8			
680	104,7								

*For additional values please check CSTB report n°26048096.

Characteristic yield strength $f_{yk} = 500 \text{ N/mm}^2$

Steel failure

b) Overlap joint application

Max. bond stress, $f_{bd, FIRE}$, depending on actual clear concrete cover for classifying the fire resistance. It must be verified that the actual force in the bar during a fire, $F_{s, T}$, can be taken up by the bar connection of the selected length, l_{inst} . Note: Cold design for ULS is mandatory.

$$F_{s, T} \leq (l_{inst} - c_f) \cdot \phi \cdot \pi \cdot f_{bd, FIRE} \quad \text{where: } (l_{inst} - c_f) \geq l_s;$$

l_s = lap length

ϕ = nominal diameter of bar

$l_{inst} - c_f$ = selected overlap joint length; this must be at least l_s ,

but may not be assumed to be more than 80ϕ

$f_{bd, FIRE}$ = bond stress when exposed to fire

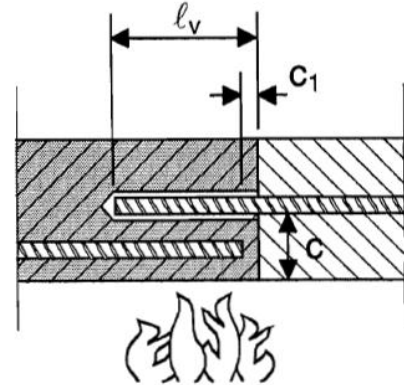

Critical temperature-dependent bond stress, $f_{bd, FIRE}$, concerning “overlap joint” for Hilti HIT-CT 1 injection adhesive in relation to fire resistance class and required minimum concrete coverage c.

Clear concrete cover c [mm]	Max. bond stress, τ_c [N/mm ²]					
	R30	R60	R90	R120	R180	R240
20	0,4					
30	0,6					
40	0,9	0,5				
50	1,2	0,6	0,4			
60	1,6	0,8	0,5	0,4		
70	2,0	1,0	0,7	0,5	0,4	
80	2,6	1,3	0,9	0,6	0,4	0,4
90	3,2	1,5	1,0	0,8	0,5	0,4
100		1,8	1,2	0,9	0,6	0,5
110		2,2	1,4	1,1	0,7	0,5
120		2,6	1,7	1,3	0,9	0,6
130		3,0	1,9	1,4	1,0	0,7
140			2,2	1,6	1,1	0,9
150			2,5	1,8	1,2	1,0
160			2,9	2,1	1,4	1,1
170			3,3	2,4	1,5	1,2
180				2,7	1,7	1,3
190				3,0	1,9	1,4
200	3,5			3,3	2,1	1,6
210					2,3	1,7
220		3,5			2,6	1,9
230					2,8	2,0
240			3,5		3,1	2,2
250				3,5	3,3	2,4
260						2,6
270						2,8
280						3,1
290					3,5	3,3
300						3,5

Materials

Material quality

Part	Material
Rebar EN 1992-1-1	Bars and de-coiled rods class B or C with f_{yk} and k according to NDP or NCL of EN 1992-1-1 $f_{uk} = f_{tk} = k \cdot f_{yk}$

Fitness for use

Some creep tests have been conducted in accordance with ETAG guideline 001 part 5 and TR 023 in the following conditions: **in dry environment at 50 °C during 90 days.**

These tests show an excellent behaviour of the post-installed connection made with HIT-CT 1: low displacements with long term stability, failure load after exposure above reference load.

Resistance to chemical substances

Chemical	Resistance	Chemical	Resistance
Acetic acid 100%	o	Methanol 100%	o
Acetic acid 10%	+	Peroxide of hydrogen 30%	o
Hydrochloric Acid 20%	+	Solution of phenol (sat.)	-
Nitric Acid 40%	-	Sodium hydroxide pH=14	+
Phosphoric Acid 40%	+	Solution of chlorine (sat.)	+
Sulphuric acid 40%	+	Solution of hydrocarbons (60 % vol Toluene, 30 % vol Xylene, 10 % vol Methyl naphthalene)	+
Ethyl acetate 100%	o	Salted solution 10%	+
Acetone 100%	-	Sodium chloride	
Ammoniac 5%	o	Suspension of concrete (sat.)	+
Diesel 100%	+	Chloroform 100%	+
Gasoline 100%	+	Xylene 100%	+
Ethanol 96%	o		
Machine oils 100%	+		

- + resistant
- o resistant in short term (max. 48h) contact
- not resistant

Electrical Conductivity

HIT-CT 1 in the hardened state **is not conductive electrically**. Its electric resistivity is $1,4 \cdot 10^{10} \Omega \cdot m$ (DIN IEC 93 – 12.93). It is adapted well to realize electrically insulating anchoring (ex: railway applications, subway).

Installation temperature range:

+5°C to +40°C

Service temperature range

Hilti HIT-CT 1 injection mortar may be applied in the temperature ranges given below. An elevated base material temperature may lead to a reduction of the design bond resistance.

Temperature range	Base material temperature	Maximum long term base material temperature	Maximum short term base material temperature
Temperature range	-40 °C to +80 °C	+50°C	+80 °C

Max short term base material temperature

Short-term elevated base material temperatures are those that occur over brief intervals, e.g. as result of diurnal cycling.

Max long term base material temperature

Long-term elevated base material temperatures are roughly constant over significant periods of time.

Working time and curing time ¹⁾

Temperature of the base material T_{BM}	Working time t_{gel}	Curing time t_{cure}
$-5\text{ °C} < t_{BM} < 0\text{ °C}$	60 min	6 h
$0\text{ °C} \leq t_{BM} < 5\text{ °C}$	40 min	3 h
$5\text{ °C} \leq t_{BM} < 10\text{ °C}$	25 min	2 h
$10\text{ °C} \leq t_{BM} < 20\text{ °C}$	10 min	90 min
$20\text{ °C} \leq t_{BM} < 30\text{ °C}$	4 min	75 min
$30\text{ °C} \leq t_{BM} < 40\text{ °C}$	2 min	60 min

1) The curing time data are valid for dry anchorage base only. For water saturated anchorage bases the curing times must be doubled.

Setting information
Installation equipment

Rebar – size	$\phi 8$	$\phi 10$	$\phi 12$	$\phi 14$	$\phi 16$	$\phi 18$	$\phi 20$	$\phi 22$	$\phi 24$	$\phi 25$
Rotary hammer	TE2(-A) – TE30(-A)					TE40 – TE80				
Other tools	Blow out pump ($h_{ef} \leq 10 \cdot d$)					-				
	Compressed air gun ^{a)} Set of cleaning brushes ^{b)} , dispenser, piston plug									

- a) Compressed air gun with extension hose for all drill holes deeper than 250 mm (for $\phi 8$ to $\phi 12$) or deeper than $20 \cdot \phi$ (for $\phi > 12$ mm)
 b) Automatic brushing with round brush for all drill holes deeper than 250 mm (for $\phi 8$ to $\phi 12$) or deeper than $20 \cdot \phi$ (for $\phi > 12$ mm)

Minimum concrete cover c_{min} of the post-installed rebar

Drilling method	Rebar – size [mm]	Minimum concrete cover c_{min} [mm]	
		Without drilling aid	With drilling aid
Hammer drilling (HD) and HD with Hilti hollow drill bit (HDB)	$\phi \leq 24$	$30 + 0,06 \cdot l_v \geq 2 \cdot \phi$	$30 + 0,02 \cdot l_v \geq 2 \cdot \phi$
	$\phi = 25$	$40 + 0,06 \cdot l_v \geq 2 \cdot \phi$	$40 + 0,02 \cdot l_v \geq 2 \cdot \phi$
Compressed air drilling (CA)	$\phi \leq 24$	$50 + 0,08 \cdot l_v$	$50 + 0,02 \cdot l_v$
	$\phi = 25$	$60 + 0,08 \cdot l_v \geq 2 \cdot \phi$	$60 + 0,02 \cdot l_v \geq 2 \cdot \phi$

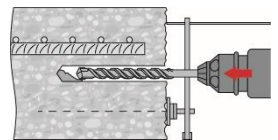

Drilling and cleaning parameters

Rebar	Hammer drilling (HD)	Hollow Drill Bit (HDB) ^{a)}	Compressed air drilling (CA)	Brush HIT-RB	Air nozzle HIT-RB
	d ₀ [mm]			size [mm]	
φ8	10	-	-	10	-
	12	12	-	12	12
φ10	12	12	-	12	12
	14	14	-	14	14
φ12	14	14	-	14	14
	16	16	-	16	16
	-	-	17	18	16
φ14	18	18	-	18	18
	-	-	17	18	16
φ16	20	20	20	20	20
φ18	22	22	22	22	22
φ20	25	25	-	25	25
	-	-	26	28	25
φ22	28	28	28	28	28
φ24	32	32	32	32	32
φ25	32	32	32	32	32

a) No cleaning required

Dispenser and corresponding maximum embedment depth $l_{v,max}$

Rebar – size [mm]	Dispenser (HDM 330, HDM 500, HDE 500)
	$l_{v,max}$ [mm]
φ8 - φ16	700
φ18 - φ25	500

Setting instructions

*For detailed information on installation see instruction for use given with the package of the product.



Safety regulations.

Review the Material Safety Data Sheet (MSDS) before use for proper and safe handling! Wear well-fitting protective goggles and protective gloves when working with Hilti HIT-CT1.

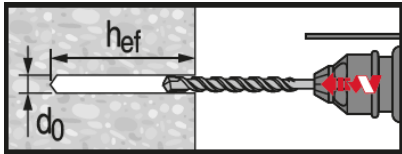

Hammer drilled hole (HD)

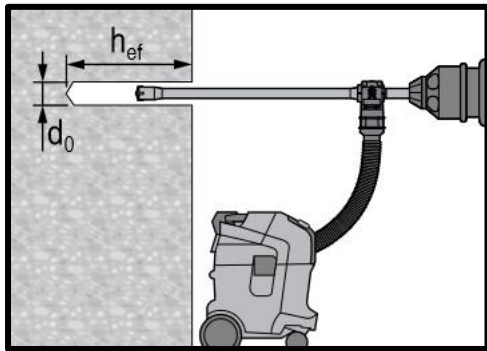

Hammer drilled hole with Hollow drill bit (HDB)

No cleaning required

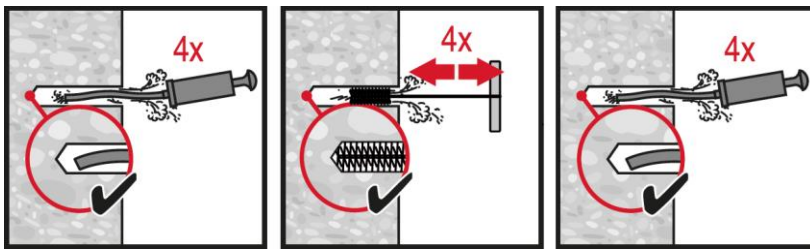

Manual cleaning (MC)

for drill diameters $d_0 \leq 20$ mm and drill hole depth $h_0 \leq 10 \cdot d$.

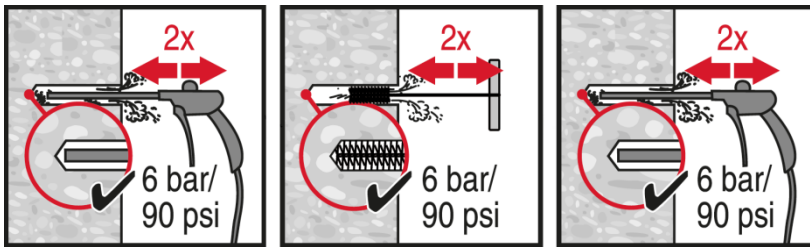

Compressed air cleaning (CAC)

for all drill hole diameters d_0 and drill hole depths $h_0 \leq 20 \cdot d$.

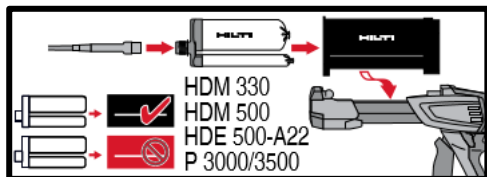

Injection system preparation.

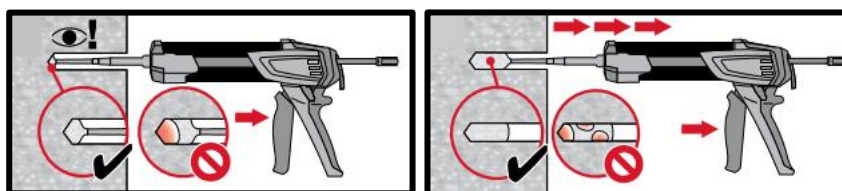
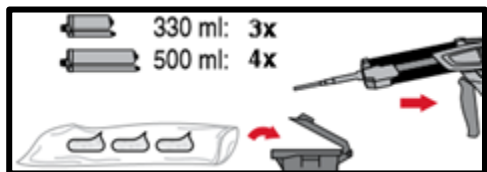

Injection method for drill hole depth

$h_{ef} \leq 250$ mm.

Concrete
Chemical anchors
Mechanical anchors
Plastic/Light duty metal anchors
Insulation anchors

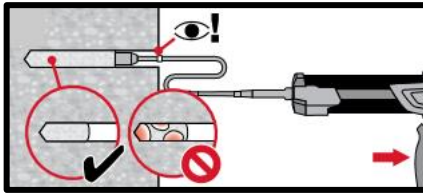
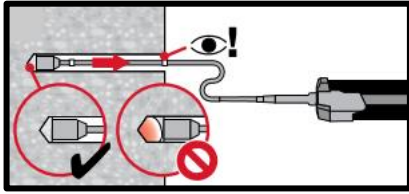

Injection method for drill hole depth $h_{ef} > 250\text{mm}$.

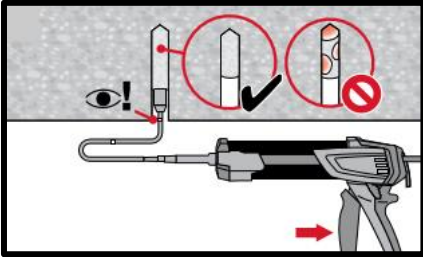
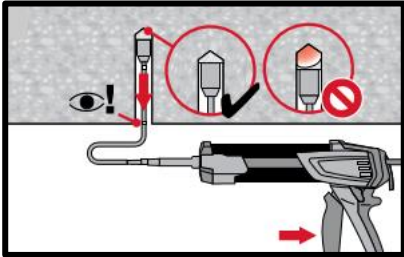

Injection method for overhead application.

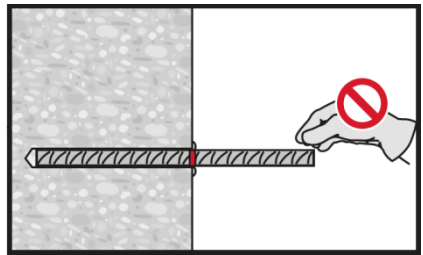
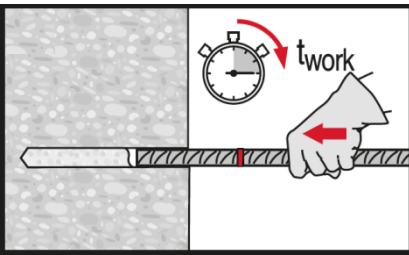

Setting element, observe working time " t_{work} ".

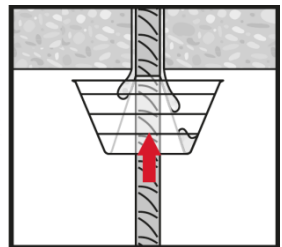
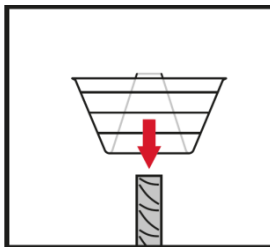
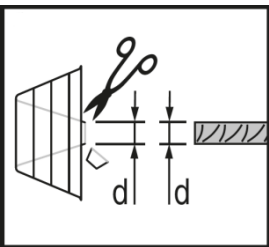

Setting element for overhead applications, observe working time " t_{work} ".

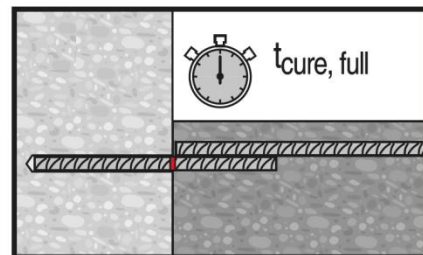
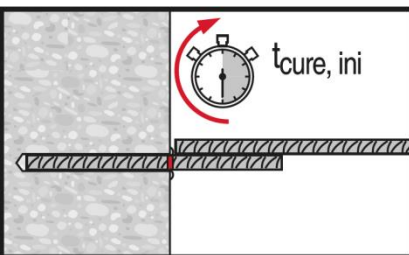
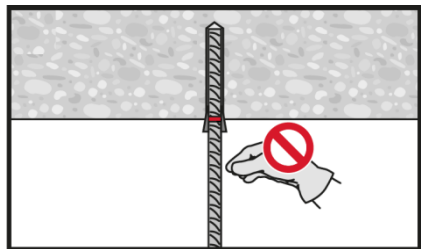
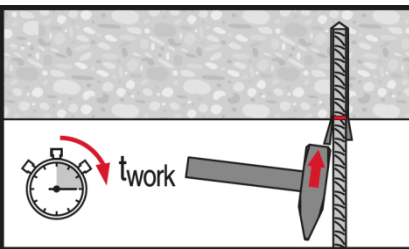

Apply full load only after curing time " t_{cure} ".

HIT-ICE injection mortar

Anchor design (ETAG 001) / Rods&Sleeves / Concrete

Concrete

Chemical anchors

Mechanical anchors

Plastic/Light duty metal anchors

Insulation anchors

Injection mortar system



Hilti HIT-ICE
296 ml cartridge

Anchor rod:
HIT-V
HIT-V-F
HIT-V-R
HIT-V-HCR rods
(M8-M24)
Anchor rod:
HAS-(E)
HAS-(E)-R
HAS-(E)-HCR rods
(M8-M24)

Internally threaded
sleeve:
HIS-N
HIS-R-N sleeves
(M8-M20)

Benefits

- Suitable for cracked ^{a)} and non-cracked concrete C 20/25 to C 50/60
- High loading capacity
- Suitable for dry and water saturated concrete
- High corrosion ^{a)} / corrosion resistant
- Odourless resin
- Low installation temperature

Base material



Concrete (non-cracked)

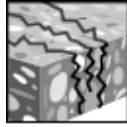

Concrete ^{a)} (cracked)



Dry concrete



Wet concrete

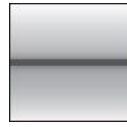

Static/
quasi-static

Load conditions

Installation conditions



Hammer drilled holes

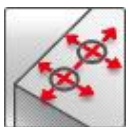

Small edge distance and spacing

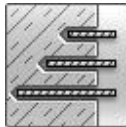

Variable embedment depth

a) Applications only for HIT-V rods.

Other information



PROFIS
Anchor design software

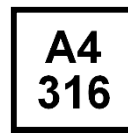

Corrosion resistance



High corrosion resistance ^{a)}

Approvals / certificates

Description	Authority / Laboratory	No. / date of issue
Hilti Technical Data ^{a)}	Hilti	2017-11-28

a) All data given in this section according to Hilti Technical Data.

Basic loading data (for a single anchor)

All data in this section applies to

- Correct setting (See setting instruction)
- No edge distance and spacing influence
- Steel failure
- Base material thickness, as specified in the table
- One typical embedment depth, as specified in the table
- One anchor material, as specified in the tables
- Concrete C 20/25, $f_{ck,cube} = 25 \text{ N/mm}^2$

Embedment depth and base material thickness

Anchor size		M8	M10	M12	M16	M20	M24
HIT-V							
Typical embedment depth	[mm]	80	90	110	125	170	210
Base material thickness	[mm]	110	120	140	165	220	270
HIS-N							
Typical embedment depth	[mm]	90	110	125	170	205	-
Base material thickness	[mm]	120	150	170	230	270	-

Characteristic resistance

Anchor size		M8	M10	M12	M16	M20	M24
Non-cracked concrete							
Tension N_{Rk}	HIT-V 5.8	17,6	29,0	42,0	66,0	96,1	142,5
	HIS-N 8.8	25,0	42,8	56,4	88,2	88,9	-
Shear V_{Rk}	HIT-V 5.8	9,0	15,0	21,0	39,0	61,0	88,0
	HIS-N 8.8	13,0	23,0	34,0	63,0	58,0	-
Cracked concrete							
Tension N_{Rk}	HIT-V 5.8	-	-	20,7	25,1	32,0	-
Shear V_{Rk}	HIT-V 5.8	-	-	21,0	39,0	61,0	-

Design resistance

Anchor size		M8	M10	M12	M16	M20	M24
Non-cracked concrete							
Tension N_{Rd}	HIT-V 5.8	11,7	16,5	24,2	36,7	53,4	79,2
	HIS-N 8.8	16,7	28,5	37,6	58,8	59,3	-
Shear V_{Rd}	HIT-V 5.8	7,2	12,0	16,8	31,2	48,8	70,4
	HIS-N 8.8	10,4	18,4	27,2	50,4	46,4	-
Cracked concrete							
Tension N_{Rd}	HIT-V 5.8	-	-	11,5	14,0	17,8	-
Shear V_{Rd}	HIT-V 5.8	-	-	16,8	31,2	42,7	-

Recommended loads ^{a)}

Anchor size		M8	M10	M12	M16	M20	M24
Non-cracked concrete							
Tension N_{Rec}	HIT-V 5.8	8,4	11,8	17,3	26,2	38,1	56,5
	HIS-N 8.8	11,9	20,4	26,8	42,0	42,3	-
Shear V_{Rec}	HIT-V 5.8	5,1	8,6	12,0	22,3	34,9	50,3
	HIS-N 8.8	7,4	13,1	19,4	36,0	33,1	-
Cracked concrete							
Tension N_{Rec}	HIT-V 5.8	-	-	8,2	10,0	12,7	-
Shear V_{Rec}	HIT-V 5.8	-	-	12,0	22,3	30,5	-

a) With overall partial safety factor for action $\gamma=1,2$. The partial safety factors for action depend on the type of loading and shall be taken from national regulations.

Materials

Mechanical properties for HIT-V / HAS

Anchor size		M8	M10	M12	M16	M20	M24
Nominal tensile strength f_{uk}	HIT-V 5.8 HAS-(E) 5.8	500	500	500	500	500	500
	HIT-V 8.8	800	800	800	800	800	800
	HIT-V-R HAS-(E)R	700	700	700	700	700	700
	HIT-V-HCR HAS-(E)HCR	800	800	800	800	800	700
Yield strength f_{yk}	HIT-V 5.8 HAS-(E) 5.8	400	400	400	400	400	400
	HIT-V 8.8	640	640	640	640	640	640
	HIT-V-R HAS-(E)R	450	450	450	450	450	450
	HIT-V-HCR HAS-(E)HCR	600	600	600	600	600	400
Stressed cross-section A_s	HIT-V	36,6	58,0	84,3	157	245	353
	HAS-(E)	32,8	52,3	76,2	144,0	225,0	324,0
Moment of resistance W	HIT-V	31,2	62,3	109,0	277,0	541,0	935,0
	HAS-(E)	27,0	54,1	93,8	244,0	474,0	809,0

Mechanical properties for HIS-N

Anchor size		M8	M10	M12	M16	M20
Nominal tensile strength f_{uk}	HIS-N	490	490	460	460	460
	Screw 8.8	800	800	800	800	800
	HIS-RN	700	700	700	700	700
	Screw A4-70	700	700	700	700	700
Yield strength f_{yk}	HIS-N	410	410	375	375	375
	Screw 8.8	640	640	640	640	640
	HIS-RN	350	350	350	350	350
	Screw A4-70	450	450	450	450	450
Stressed cross-section A_s	HIS-(R)N	51,5	108,0	169,1	256,1	237,6
	Screw	36,6	58	84,3	157	245
Moment of resistance W	HIS-(R)N	145	430	840	1595	1543
	Screw	31,2	62,3	109	277	541

Material quality for HIT-V

Part	Material
Zinc coated steel	
Threaded rod, HIT-V 5.8 (F) HAS-(E) 5.8	Strength class 5.8; Elongation at fracture A5 > 8% ductile Electroplated zinc coated $\geq 5\mu\text{m}$; (F) hot dip galvanized $\geq 45\mu\text{m}$
Threaded rod, HIT-V 8.8 (F) HAS-(E) 8.8	Strength class 8.8; Elongation at fracture A5 > 12% ductile Electroplated zinc coated $\geq 5\mu\text{m}$; (F) hot dip galvanized $\geq 45\mu\text{m}$
Washer	Electroplated zinc coated $\geq 5\mu\text{m}$, hot dip galvanized $\geq 45\mu\text{m}$
Nut	Strength class of nut adapted to strength class of threaded rod. Electroplated zinc coated $\geq 5\mu\text{m}$, hot dip galvanized $\geq 45\mu\text{m}$
Stainless Steel	
Threaded rod, HIT-V-R HAS-(E)-R	Strength class 70 for $\leq \text{M}24$ and strength class 50 for $> \text{M}24$; Elongation at fracture A5 > 8% ductile Stainless steel 1.4401; 1.4404; 1.4578; 1.4571; 1.4439; 1.4362
Washer	Stainless steel 1.4401, 1.4404, 1.4578, 1.4571, 1.4439, 1.4362 EN 10088-1:2014
Nut	Stainless steel 1.4401, 1.4404, 1.4578, 1.4571, 1.4439, 1.4362 EN 10088-1:2014
High corrosion resistant steel	
Threaded rod, HIT-V-HCR HAS-(E)-HCR	Strength class 80 for $\leq \text{M}20$ and class 70 for $> \text{M}20$, Elongation at fracture A5 > 8% ductile High corrosion resistance steel 1.4529; 1.4565;
Washer	High corrosion resistant steel 1.4529, 1.4565 EN 10088-1:2014
Nut	High corrosion resistant steel 1.4529, 1.4565 EN 10088-1:2014

Material quality for HIS-N

Part	Material	
HIS-N	Internally threaded sleeves	C-steel 1.0781 Steel galvanized $\geq 5\mu\text{m}$
	Screw 8.8	Strength class 8.8, A5 > 8% ductile Steel galvanized $\geq 5\mu\text{m}$
HIS-RN	Internally threaded sleeves	Stainless steel 1.4401 and 1.4571
	Screw A4-70	Strength 70, A5 > 8% ductile Stainless steel 1.4401, 1.4404, 1.4578, 1.4571, 1.4439, 1.4362

Anchor dimension

Anchor size	M8	M10	M12	M16	M20	M24
HAS-(E), HAS-(E)-R, HAS-(E)-HCR	M8x80	M10x90	M12x110	M16x125	M20x170	M24x210
HIT-V, HIT-V-R, HIT-V-HCR	Anchor rods HIT-V (-R/-HCR) are available in variable length					
HIS-(R)N	M8x90	M10x90	M12x110	M16x125	M20x170	-

Setting information

Installation temperature range:

-23°C to +32°C

In service temperature range

Hilti HIT-ICE injection mortar may be applied in the temperature ranges given below. An elevated base material temperature may lead to a reduction of the design bond resistance.

Temperature in base material

Temperature range	Base material temperature	Max. long term base material temperature	Max. short term base material temperature
Temperature range I	-40 °C to + 40 °C	+ 24 °C	+ 40 °C
Temperature range II	-40 °C to + 54 °C	+ 43 °C	+ 54 °C

Max. short term base material temperature

Short term elevated base material temperatures are those that occur over brief intervals, e.g. as a result of diurnal cycling.

Max. long term base material temperature

Long term elevated base material temperatures are roughly constant over significant periods of time.

Working time and curing time

Temperature of the base material	Curing time before anchor can be fully loaded t_{cure}	Working time in which anchor can be inserted and adjusted t_{work}
32 °C	35 min	1 min
21 °C	45 min	2,5 min
16 °C	1 h	5 min
4 °C	1,5 h	15 min
-7 °C	6 h	1 h
-18 °C	24 h	1,5 h
-23 °C	36 h	1,5 h

Setting details

Anchor size		M8	M10	M12	M16	M20	M24
Nominal diameter of drill bit d_0	[mm]	10	12	14	18	24	28
Effective anchorage and drill hole depth h_{ef}	[mm]	60 to 160	60 to 200	70 to 240	80 to 320	90 to 400	96 to 480
Min. base material thickness ^{a)} h_{min}	[mm]	$h_{ef} + 30 \geq 100$ mm			$h_{ef} + 2 d_0$		
Diameter of clearance hole in the fixture d_f	[mm]	9	12	14	18	22	26
Minimum spacing s_{min}	[mm]	40	50	60	80	100	120
Minimum edge distance c_{min}	[mm]	40	45	45	50	55	60
Critical spacing for splitting failure $s_{cr,sp}$	[mm]	$2 C_{cr,sp}$					
Critical edge distance for splitting failure ^{b)} $c_{cr,sp}$	[mm]	$1,0 \cdot h_{ef}$ for $h / h_{ef} \geq 2,0$					
		$4,6 h_{ef} - 1,8 h$ for $2,0 > h / h_{ef} > 1,3$					
		$2,26 h_{ef}$ for $h / h_{ef} \leq 1,3$					
Critical spacing for concrete cone failure $s_{cr,N}$	[mm]	$2 C_{cr,N}$					
Critical edge distance for concrete cone failure ^{b)} $c_{cr,N}$	[mm]	$1,5 h_{ef}$					
Torque moment ^{c)} T_{max}	[Nm]	10	20	40	80	150	200

For spacing (edge distance) smaller than critical spacing (critical edge distance) the design loads have to be reduced.

- h : base material thickness ($h \geq h_{min}$)
- The critical edge distance for concrete cone failure depends on the embedment depth h_{ef} and the design bond resistance. The simplified formula given in this table is on the safe side.
- This is the maximum recommended torque moment to avoid splitting failure during installation for anchors with minimum spacing and / or edge distance.

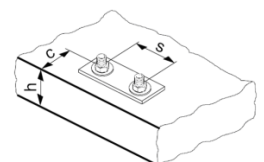
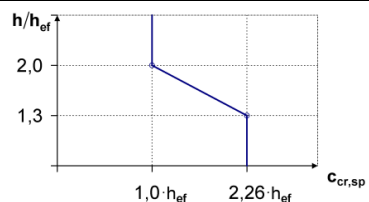

Installation equipment

Anchor size		M8	M10	M12	M16	M20	M24
Rotary hammer	HIT-V	TE 2 – TE 30			TE 40 – TE 70		
	HIS-N	TE 2 – TE 30		TE 40 – TE 70		-	
Other tools		Compressed air gun or blow out pump					
		Set of cleaning brushes, dispenser					

Drilling and cleaning parameters

HIT-V HAS	HIS-N	Hammer drill (HD)	Brush HIT-RB
		d_0 [mm]	size [mm]
M8	-	10	10
M10	-	12	12
M12	M8	14	14
M16	M10	18	18
-	M12	22	22
M20	-	24	24
M24	M16	28	28
M27	-	30	30
-	M20	32	32

Setting instructions

*For detailed information on installation see instruction for use given with the package of the product.



Safety regulations.

Review the Material Safety Data Sheet (MSDS) before use for proper and safe handling! Wear well-fitting protective goggles and protective gloves when working with Hilti HIT-ICE.

Drilling

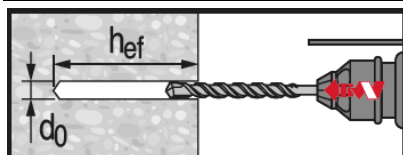

Hammer drilled hole (HD)

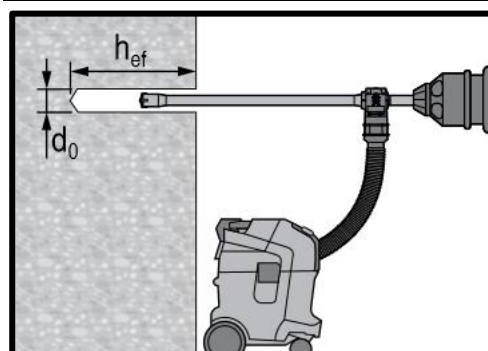

Hammer drilled hole with Hollow Drilled Bit (HDB)

No cleaning required.
For dry and wet concrete, only.

Cleaning

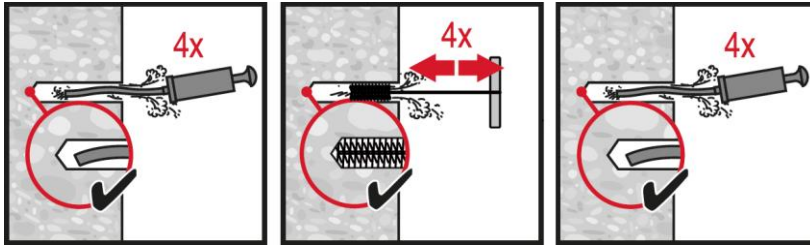

Hammer Drilling:

Manual cleaning (MC)

for drill diameters $d_0 \leq 16$ mm and drill hole depth $h_0 \leq 10 \cdot d$.

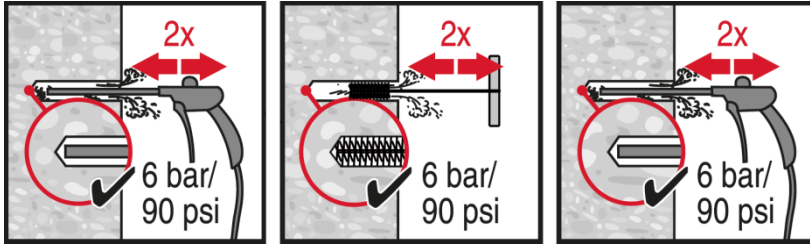

Hammer Drilling:

Compressed air cleaning (CAC)

For all drill hole diameters d_0 and all drill hole depths h_0 .

Injection system

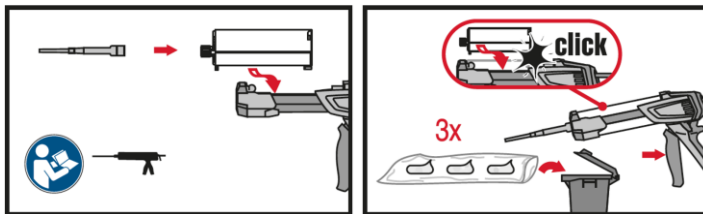

Injection system preparation.

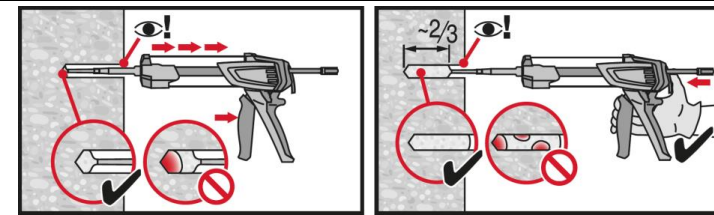

Injection method for drill hole depth

$h_{ef} \leq 250$ mm.

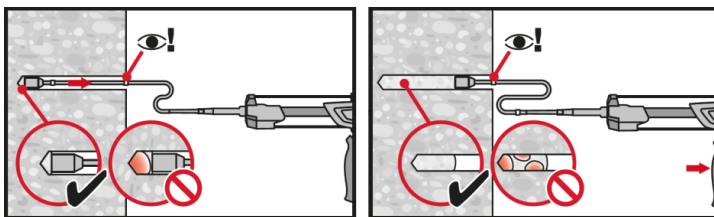

Injection method for drill hole depth

$h_{ef} > 250$ mm.

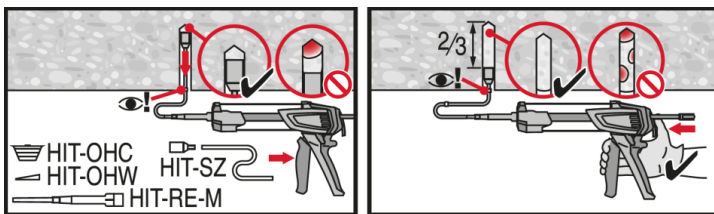

Injection method for overhead

application.

Setting the element

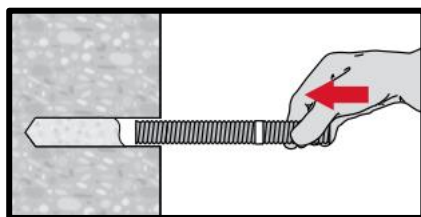

Setting element, observe working time " t_{work} ".

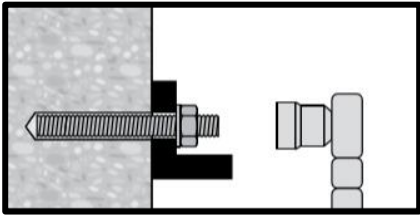

Loading the anchor: After required curing time t_{cure} the anchor can be loaded.

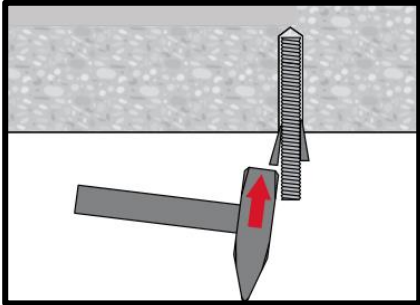

Setting element for overhead applications, observe working time " t_{work} ".

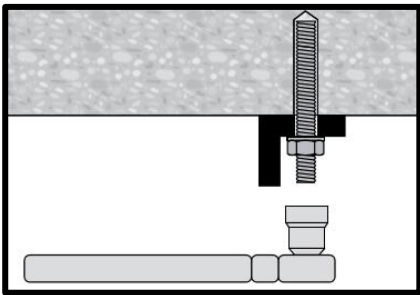

Loading the anchor after required curing time t_{cure} the anchor can be loaded.

Concrete

Chemical anchors

Mechanical anchors

Plastic/Light duty metal anchors

Insulation anchors

HIT-ICE injection mortar

Anchor design (ETAG 001) / Rebar elements / Concrete

Concrete

Chemical anchors

Mechanical anchors

Plastic/Light duty metal anchors

Insulation anchors

Injection mortar system



Hilti HIT-ICE
296 ml cartridge



Rebar B500 B
(φ8 - φ25)

Benefits

- Suitable for non-cracked concrete C20/25 to C50/60
- Suitable for dry and water saturated concrete
- High loading capacity
- High corrosion resistant
- Odourless resin
- Low installation temperature

Base material



Concrete
(non-cracked)



Dry concrete



Wet concrete

Load condition

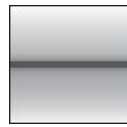

Static/
quasi-static

Installation conditions

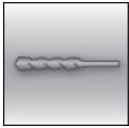

Hammer
drilling

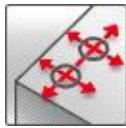

Small edge
distance and
spacing

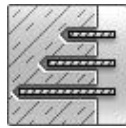

Variable
embedment
depth

Other information



PROFIS
Rebar design
Software

Approvals / certificates

Description	Authority / Laboratory	No. / date of issue
Hilti Technical Data ^{a)}	Hilti	2017-11-28

a) All data given in this section according to Hilti Technical Data.

Basic loading data (for a single anchor)

All data in this section applies to

- Correct setting
- No edge distance and spacing influence
- Steel* failure
- Base material thickness, as specified in the table
- One typical embedment depth, as specified in the table
- One anchor material, as specified in the tables
- Concrete C20/25, $f_{ck,cube} = 25 \text{ N/mm}^2$

Embedment depth and base material thickness for static and quasi-static loading data

Anchor- size		φ8	φ10	φ12	φ14	φ16	φ20	φ25
Typical embedment depth	h_{ef} [mm]	80	90	110	125	125	170	210
Base material thickness	h_{min} [mm]	110	120	145	165	165	220	275

Characteristic resistance for rebar B500 B

Anchor- size		φ8	φ10	φ12	φ14	φ16	φ20	φ25
Tensile N_{Rk}	[kN]	17,1	24,0	35,2	46,7	53,4	85,5	131,9
Shear V_{Rk}		14,0	22,0	31,0	42,0	55,0	86,0	135,0

Design resistance for rebar B500 B

Anchor- size		φ8	φ10	φ12	φ14	φ16	φ20	φ25
Tensile N_{Rd}	[kN]	9,5	13,4	19,6	26,0	29,7	47,5	73,3
Shear V_{Rd}		9,3	14,7	20,7	28,0	36,7	57,3	90,0

Recommended loads ^{a)} for rebar B500 B

Anchor- size		φ8	φ10	φ12	φ14	φ16	φ20	φ25
Tensile N_{Rec}	[kN]	6,8	9,5	14,0	18,5	21,2	33,9	52,4
Shear V_{Rec}		6,7	10,5	14,8	20,0	26,2	41,0	64,3

a) With overall partial safety factor for action $\gamma=1,2$. The partial safety factors for action depend on the type of loading and shall be taken from national regulations.

Materials

Mechanical properties for rebar B500 B

Anchor size		φ8	φ10	φ12	φ14	φ16	φ20	φ25
Nominal tensile strength f_{uk}	[N/mm ²]	550	550	550	550	550	550	550
Yield strength f_{yk}	[N/mm ²]	500	500	500	500	500	500	500
Stressed cross-section A_s	[mm ²]	50,3	78,5	113,1	153,9	201,1	314,2	490,9
Moment of resistance W	[mm ³]	50,3	98,2	169,6	269,4	402,1	785,4	1534

Material quality

Part	Material
Rebar B500 B	Geometry and mechanical properties according to DIN 488-2:1986 or DIN 488-2

Setting information

Installation temperature range:
-23°C to +32°C

Service temperature range

Hilti HIT-ICE injection mortar may be applied in the temperature ranges given below. An elevated base material temperature may lead to a reduction of the design bond resistance.

Temperature range	Base material temperature	Max. long term base material temperature	Max. short term base material temperature
Temperature range I	-40 °C to + 40 °C	+ 24 °C	+ 40 °C
Temperature range II	-40 °C to + 40 °C	+ 43 °C	+ 54 °C

Max. short term base material temperature

Short term elevated base material temperatures are those that occur over brief intervals, e.g. as a result of diurnal cycling.

Max. long term base material temperature

Long term elevated base material temperatures are roughly constant over significant periods of time.

Working time and curing time

Temperature of the base material	Curing time before anchor can be fully loaded t_{cure}	Working time in which anchor can be inserted and adjusted t_{work}
32 °C	35 min	1 min
21 °C	45 min	2,5 min
16 °C	1 h	5 min
4 °C	1,5 h	15 min
-7 °C	6 h	1 h
-18 °C	24 h	1,5 h
-23 °C	36 h	1,5 h

1) The curing time data are valid for dry base material only. In wet material the curing times must be doubled.

Installation equipment

Anchor size	Ø8	Ø10	Ø12	Ø14	Ø16	Ø20	Ø25
Rotary hammer	TE 2 – TE 16					TE 40 – TE 80	
Other tools	Compressed air gun, blow out pump Set of cleaning brushes, dispenser						

Setting details

Anchor size		Ø8	Ø10	Ø12	Ø14	Ø16	Ø20	Ø25
Nominal diameter of drill bit d_0	[mm]	12	14	16	18	20	25	32
Effective anchorage and drill hole depth range ^{a)}	h_{ef} [mm]	60 to 160	60 to 200	70 to 240	75 to 280	80 to 320	90 to 400	100 to 500
Minimum base material thickness	h_{min} [mm]	$h_{ef} + 30 \text{ mm} \geq 100 \text{ mm}$		$h_{ef} + 2 d_0$				
Minimum spacing	s_{min} [mm]	40	50	60	70	80	100	125
Minimum edge distance	c_{min} [mm]	40	50	60	70	80	100	125
Critical spacing for splitting failure	$s_{cr,sp}$ [mm]	$2 c_{cr,sp}$						
Critical edge distance for splitting failure ^{b)}	$c_{cr,sp}$ [mm]	$1,0 \cdot h_{ef}$ for $h / h_{ef} \geq 2,0$						
		$4,6 h_{ef} - 1,8 h$ for $2,0 > h / h_{ef} > 1,3$						
		$2,26 h_{ef}$ for $h / h_{ef} \leq 1,3$						
Critical spacing for concrete cone failure	$s_{cr,N}$ [mm]	$2 c_{cr,N}$						
Critical edge distance for concrete cone failure	$c_{cr,N}$ [mm]	$1,5 h_{ef}$						

For spacing (edge distance) smaller than critical spacing (critical edge distance) the design loads have to be reduced.

a) h : base material thickness ($h \geq h_{min}$)

b) The critical edge distance for concrete cone failure depends on the embedment depth h_{ef} and the design bond resistance. The simplified formula given in this table is on the safe side.

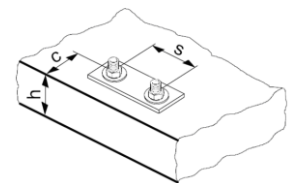

Setting instructions

*For detailed information on installation see instruction for use given with the package of the product.



Safety regulations.

Review the Material Safety Data Sheet (MSDS) before use for proper and safe handling! Wear well-fitting protective goggles and protective gloves when working with Hilti HIT-ICE

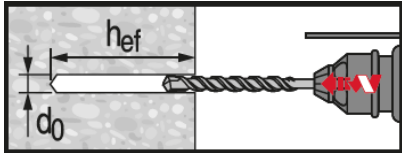

Hammer drilled hole (HD)

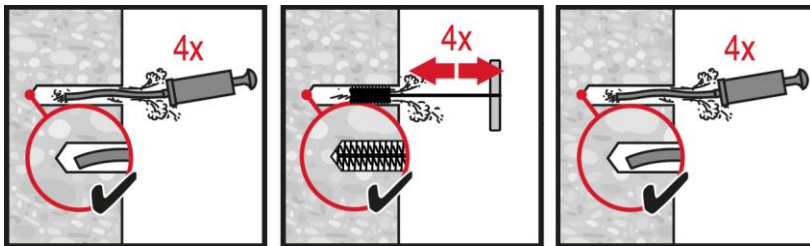

Manual cleaning (MC)

For element sizes $d \leq 16\text{mm}$ and embedment depth $h_{ef} \leq 10d$ only.

Brush bore hole with required steel brush HIT-RB.

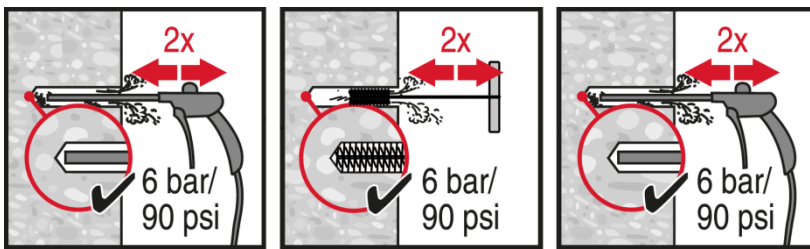

Compressed air cleaning (CAC)

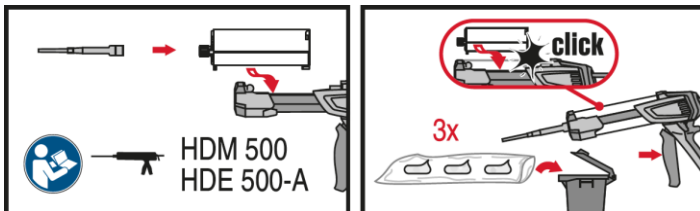

Injection system preparation.

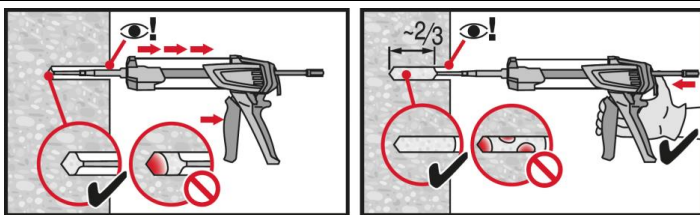

Injection method for drill hole depth $h_{ef} > 250\text{mm}$

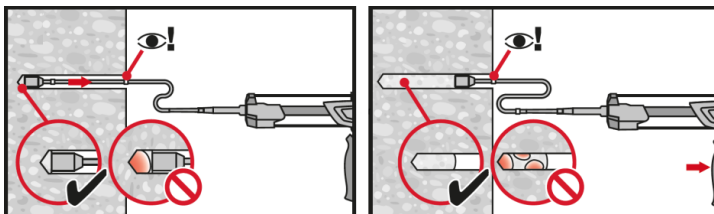

Injection method for drill hole depth $h_{ef} > 250\text{mm}$.

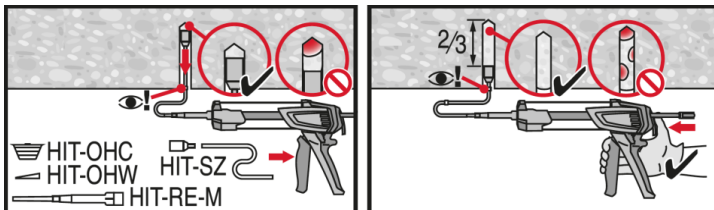

Injection method for overhead application.

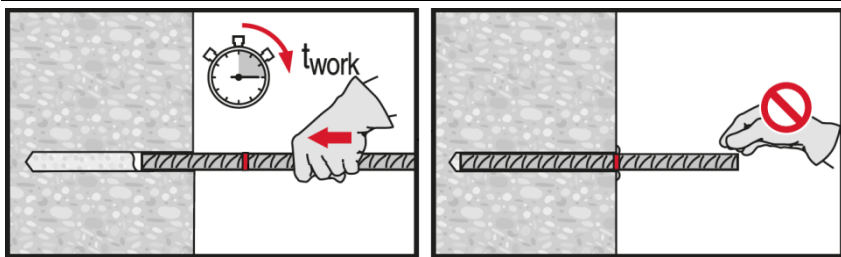

Setting element, observe working time "t_{work}".

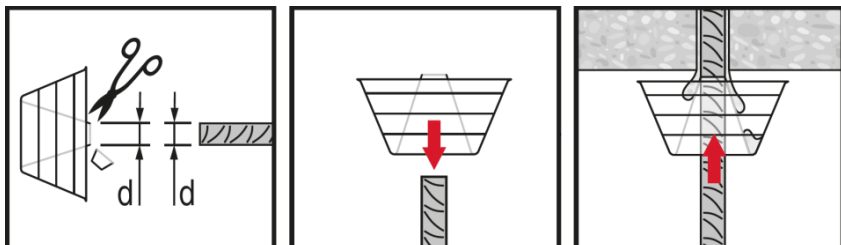

Setting element for overhead applications, observe working time "t_{work}".

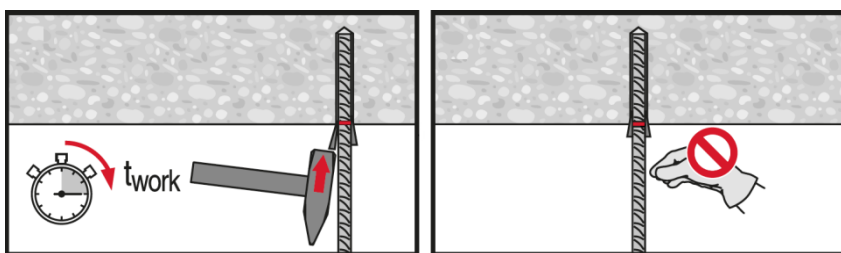

HVZ (HVU-TZ+HAS-TZ) adhesive anchor system

Anchor design (ETAG 001) / Rods&Sleeves / Concrete

Concrete

Chemical anchors

Mechanical anchors

Plastic/Light duty metal anchors

Insulation anchors

Anchor version



HVZ
Mortar capsule



Anchor rod:
HAS-TZ
HAS-R-TZ
HAS-HCR-TZ
(M10-M20)

Benefits

- Suitable for cracked and non-cracked concrete C20/25 to C50/60
- High loading capacity
- Suitable for dry and water saturated concrete

Base material



Concrete (non-cracked)



Concrete (cracked)

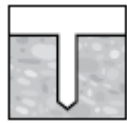

Dry concrete

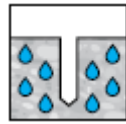

Wet concrete

Load conditions

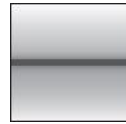

Static/
quasi-static



Fire
resistance

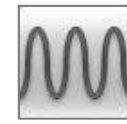

Fatigue



Shock

Installation conditions

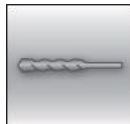

Hammer
drilled
holes

SAFE-SET

Hilti
SafeSet
technology

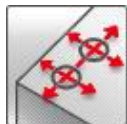

Small edge
distance
and
spacing



European
Technical
Assessment



CE
conformity

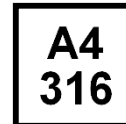

Corrosion
resistance



High
corrosion
resistance



PROFIS
design
Software

Other information

Approvals / certificates

Description	Authority / Laboratory	No. / date of issue
European Technical Assessment ^{a)}	DIBt, Berlin	ETA-03/0032 / 2015-08-27
Approval for shockproof fastenings in civil defence installations	Federal Office for Civil Protection, Bern	BZS D 09-602 / 2009-10-28
Fatigue loading	DIBt, Berlin	Z-21.3-1692 / 2016-10-14
Fire test report ZTV – Tunnel	IBMB, Braunschweig	UB 3357/0550-2 / 2001-06-26
Fire test report	IMBM, Brunswick	UB 3357/0550-1 / 2001-04-17
Assessment report (fire)	Warringtonfire	WF 327804/B / 2013-07-10

a) All data given in this section according to ETA-03/0032, issue 2015-08-27.

Static and quasi-static resistance (for a single anchor)

All data in this section applies to:

- Correct setting (See setting instruction)
- No edge distance and spacing influence
- *Steel* failure
- Base material thickness, as specified in the table
- Embedment depth, as specified in the table
- One anchor material, as specified in the tables
- Concrete C 20/25, $f_{ck,cube} = 25 \text{ N/mm}^2$
- Temperature range I
(min. Base material temperature -40°C , max. Long term/short term base material temperature: $+50^\circ\text{C}/80^\circ\text{C}$)

Effective anchorage depth for static

Anchor size			M10	M12	M16		M20
Eff. Anchorage depth	h_{ef}	[mm]	75	95	105	125	170
Base material thickness	h_{min}	[mm]	150	190	210	250	340

Mean ultimate resistance

Anchor size		M10x75	M12x95	M16x105	M16x125	M20x170
Non-cracked concrete						
Tension $N_{Ru,m}$	HAS-TZ	36,8	53,3	72,4	94,1	149,2
	HAS-RTZ, HAS-HCR-TZ	36,8	53,3	72,4	94,1	149,2
Shear $V_{Ru,m}$	HAS-TZ	18,9	28,4	53,6	53,6	92,4
	HAS-RTZ, HAS-HCR-TZ	21,0	31,5	58,8	58,8	102,9
Cracked concrete						
Tension $N_{Ru,m}$	HAS-TZ	31,2	44,4	51,6	67,1	106,4
	HAS-RTZ, HAS-HCR-TZ	31,2	44,4	51,6	67,1	106,4
Shear $V_{Ru,m}$	HAS-TZ	18,9	28,4	53,6	53,6	92,4
	HAS-RTZ, HAS-HCR-TZ	21,0	31,5	58,8	58,8	102,9

Characteristic resistance

Anchor size		M10x75	M12x95	M16x105	M16x125	M20x170
Non-cracked concrete						
Tension N_{Rk}	HAS-TZ	32,8	40,0	54,3	70,6	111,9
	HAS-RTZ, HAS-HCR-TZ	32,8	40,0	54,3	70,6	111,9
Shear V_{Rk}	HAS-TZ	18,0	27,0	51,0	51,0	88,0
	HAS-RTZ, HAS-HCR-TZ	20,0	30,0	56,0	56,0	98,0
Cracked concrete						
Tension N_{Rk}	HAS-TZ	23,4	33,3	38,7	50,3	79,8
	HAS-RTZ, HAS-HCR-TZ	23,4	33,3	38,7	50,3	79,8
Shear V_{Rk}	HAS-TZ	18,0	27,0	51,0	51,0	88,0
	HAS-RTZ, HAS-HCR-TZ	20,0	30,0	56,0	56,0	98,0

Design resistance

Anchor size		M10x75	M12x95	M16x105	M16x125	M20x170
Non-cracked concrete						
Tension N_{Rd}	HAS-TZ [kN]	21,9	26,7	36,2	47,1	74,6
	HAS-RTZ, HAS-HCR-TZ	21,9	26,7	36,2	47,1	74,6
Shear V_{Rd}	HAS-TZ [kN]	14,4	21,6	40,8	40,8	70,4
	HAS-RTZ, HAS-HCR-TZ	16,0	24,0	44,8	44,8	78,4
Cracked concrete						
Tension N_{Rd}	HAS-TZ [kN]	15,6	22,2	25,8	33,5	53,2
	HAS-RTZ, HAS-HCR-TZ	15,6	22,2	25,8	33,5	53,2
Shear V_{Rd}	HAS-TZ [kN]	14,4	21,6	40,8	40,8	70,4
	HAS-RTZ, HAS-HCR-TZ	16,0	24,0	44,8	44,8	78,4

Recommended loads ^{a)}

Anchor size		M10x75	M12x95	M16x105	M16x125	M20x170
Non-cracked concrete						
Tension N_{Rec}	HAS-TZ [kN]	15,6	19,0	25,9	33,6	53,3
	HAS-RTZ, HAS-HCR-TZ	15,6	19,0	25,9	33,6	53,3
Shear V_{Rec}	HAS-TZ [kN]	10,3	15,4	29,1	29,1	50,3
	HAS-RTZ, HAS-HCR-TZ	11,4	17,1	32,0	32,0	56,0
Cracked concrete						
Tension N_{Rec}	HAS-TZ [kN]	11,1	15,9	18,4	24,0	38,0
	HAS-RTZ, HAS-HCR-TZ	11,1	15,9	18,4	24,0	38,0
Shear V_{Rec}	HAS-TZ [kN]	10,3	15,4	29,1	29,1	50,3
	HAS-RTZ, HAS-HCR-TZ	11,4	17,1	32,0	32,0	56,0

a) With overall partial safety factor for action $\gamma = 1,4$. The partial safety factors for action depend on the type of loading and shall be taken from national regulations.

Materials

Mechanical properties

Anchor size		M10x75	M12x95	M16x105	M16x125	M20x170
Nominal tensile strength f_{uk}	[N/mm ²]	800	800	800	800	800
Yield strength f_{yk}	[N/mm ²]	640	640	640	640	640
Stressed cross-section A_s	tension [mm ²]	44,2	63,6	113	113	227
	shear [mm ²]	50,3	73,9	141	141	245
Moment of resistance W	HVZ [mm ³]	50,3	89,6	236	236	541

Material quality

Part	Material
HAS-TZ	carbon steel, strength class 8.8
HAS-R-TZ	stainless steel 1.4401 and 1.4571
HAS-HCR-TZ	high corrosion resistance steel 1.4529 and 1.4547

Setting information

Installation temperature range:

-5°C to +40°C

In service temperature range

Hilti HVZ adhesive anchor with anchor rod HAS-TZ may be applied in the temperature ranges given below. An elevated base material temperature may lead to a reduction of the design bond resistance.

Temperature range	Base material temperature	Maximum long term base material temperature	Maximum short term base material temperature
Temperature range I	-40 °C to +80 °C	+ 50°C	+ 80°C

Max short term base material temperature

Short-term elevated base material temperatures are those that occur over brief intervals, e.g. as a result of diurnal cycling.

Max long term base material temperature

Long-term elevated base material temperatures are roughly constant over significant periods of time.

Curing time

Temperature of the base material	Release screwed on setting tool curing time t_{rel}	Full load curing time t_{cure}
$-5\text{ °C} \leq T_{BM} < 0\text{ °C}$	60 min	5 hour
$0\text{ °C} \leq T_{BM} < 10\text{ °C}$	30 min	1 hour
$10\text{ °C} \leq T_{BM} < 20\text{ °C}$	20 min	30 min
$20\text{ °C} \leq T_{BM} < 40\text{ °C}$	8 min	20 min

Setting details

Anchor size		M10x75	M12x95	M16x105	M16x125	M20x170
Diameter of element	d [mm]	10	12	16	16	20
Nominal diameter of drill bit	d_0 [mm]	12	14	18	18	25
Effective anchorage depth	h_{ef} [mm]	75	95	105	125	170
Drill hole depth	h_1 [mm]	90	110	125	145	195
Min. thickness of concrete member	$h_{min}^{a)}$ [mm]	150	190	210	250	340
Diameter of clearance hole in the fixture	d_f [mm]	12	14	18	18	22
Cracked concrete						
Min. spacing	s_{min} [mm]	50	60	70	70	80
Min. edge distance	c_{min} [mm]	50	60	70	70	80
Non-cracked concrete						
Min. spacing	s_{min} [mm]	50	60	70	70	80
Min. edge distance	c_{min} [mm]	50	70	85	85	80
Critical spacing for splitting failure	$s_{cr,sp}$ [mm]	2 $c_{cr,sp}$				
Critical edge distance for splitting failure ^{a)}	$c_{cr,sp}$ [mm]	1,5 h_{ef}				
Critical spacing for concrete cone failure	$s_{cr,N}$ [mm]	2 $c_{cr,N}$				
Critical edge distance for concrete cone failure ^{b)}	$c_{cr,N}$ [mm]	1,5 h_{ef}				
Torque moment ^{c)}	[Nm]	40	50	90	90	150

For spacing (edge distance) smaller than critical spacing (critical edge distance) the design loads have to be reduced.

a) h: base material thickness ($h \geq h_{min}$)

b) The critical edge distance for concrete cone failure depends on the embedment depth h_{ef} and the design bond resistance. The simplified formula given in this table is on the same side.



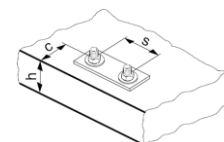

c) Max. recommended torque moment to avoid splitting failure during installation with min. spacing and/or edge distance



Installation equipment

Anchor size	M10x75	M12x95	M16x105	M16x125	M20x170
Rotary hammer	TE 1 -TE 30		TE 1 – TE 60		TE 30 – TE 80
Tools	compressed air gun and blow out pump, set of cleaning brushes, dispenser				

Drilling and cleaning parameters

HAS-TZ	Hammer drill	Hollow Drill Bit	Brush HIT-RB
	d_0 [mm]	size [mm]	
			
M10	10	-	10
M12	12	-	12
M16	16	16	16
M20	20	20	20

Setting instructions

*For detailed information on installation see instruction for use given with the package of the product.



Safety regulations.

Review the Material Safety Data Sheet (MSDS) before use for proper and safe handling! Wear well-fitting protective goggles and protective gloves when working with Hilti HVZ.

Hole drilling

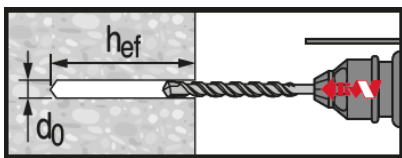

Hammer drilled hole

For dry or wet concrete and installation in flooded holes (no sea water).

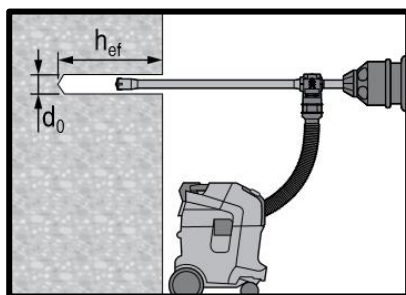

Hammer drilled hole with Hollow drill bit

For dry and wet concrete, only.
No cleaning required.

Hole cleaning

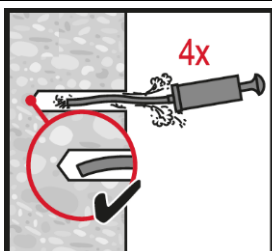

Manual cleaning for hammer drilled hole

Setting the element

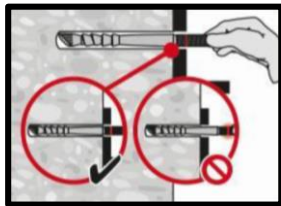
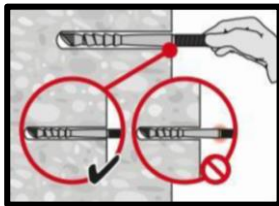

Check the setting depth.

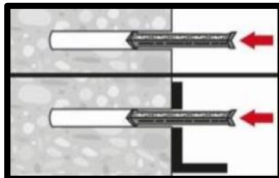

Insert the foil capsule with the peak ahead to the back of the hole.

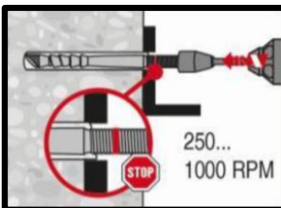
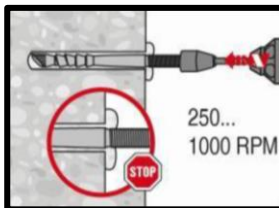

Drive the anchor rod with the plugged tool into the hole.

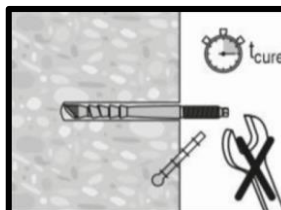
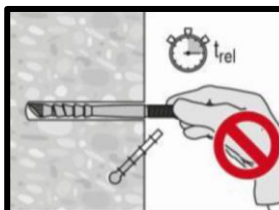

After **required time** remove the screwed on setting tool and excess mortar

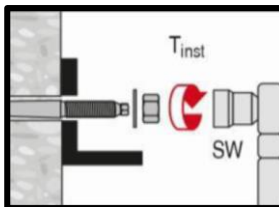

Loading the anchor after required curing time t_{cure} and apply installation torque

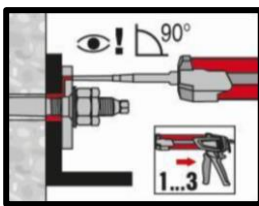
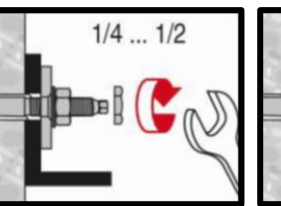
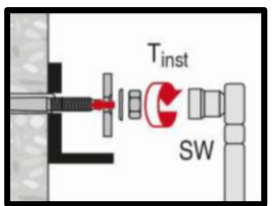

Use of filling set. Apply installation torque after required curing time, apply the lock nut and fill annular gap between anchor rod and picture

HVU2 adhesive capsule



Anchor design (ETAG 001) / Rods&Sleeves / Concrete







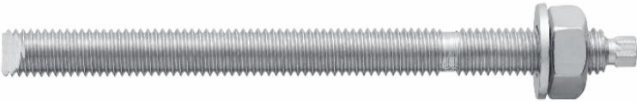



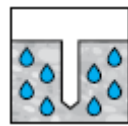
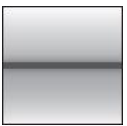

Concrete
Chemical anchors

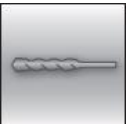
Mechanical anchors

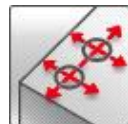
Plastic/Light duty metal anchors

Insulation anchors

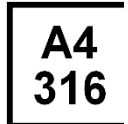
Anchor version	Benefits
 <p>HVU2 Mortar capsule</p>	<ul style="list-style-type: none"> - SafeSet technology: Hilti hollow drill bit for automatic cleaning - Suitable for cracked and non-cracked concrete C20/25 to C50/60 both for hammer drilled and diamond cored holes - Highly reliable and safe anchor for seismic design with ETA C1/C2 approval - Clean and fast installation that suits hard jobsite conditions - Suitable for dry and water saturated concrete - High loading capacity - Low curing time - Max. in service temperature range up to 120°C short term / 72°C long term
 <p>Anchor rod: HAS HAS-R HAS-HCR (M8-M30)</p>	
 <p>Anchor rod: HAS-E HAS-E-R HAS-E-HCR (M8-M30)</p>	
 <p>Internally threaded sleeve: HIS-N HIS-RN (M8-M20)</p>	

Base material				Load conditions				
								
Concrete (non-cracked)	Concrete (cracked)	Dry concrete	Wet concrete	Static/ quasi-static	Fire resistance	Seismic ETA-C1/C2		
Installation conditions			Other information					
								
Hammer drilled holes	Diamond drilled holes	Hilti SafeSet technology	Small edge distance and spacing	European Technical Assessment	CE conformity	PROFIS design Software	Corrosion resistance	High corrosion resistance

Approvals / certificates

Description	Authority / Laboratory	No. / date of issue
European Technical Assessment ^{a)}	DIBt, Berlin	ETA-16/0515 / 2017-12-14
European Technical Assessment ^{b)}	DIBt, Berlin	ETA-18/0185 / 2018-05-14
European Technical Assessment ^{c)}	DIBt, Berlin	ETA-18/0184 / 2018-08-17
Fire test assessment	ING.Thiele, Pirmasens	21735 / 2017-08-01

a) applies to M8 to M20 under static loading b) applies to M24 to M30 under static loading c) applies to M10 to M30 under seismic loading

Static and quasi-static resistance (for a single anchor)
All data in this section applies to:

- Correct setting (See setting instruction)
- No edge distance and spacing influence
- *Steel* failure
- Minimum base material thickness
- Concrete C20/25, $f_{ck,cube} = 25 \text{ N/mm}^2$
- Temperature range I: -40 °C to $+40 \text{ °C}$
(max. long term temperature $+24 \text{ °C}$ and max. short term temperature $+40 \text{ °C}$)
- All data given in this section according ETA-16/0515, issue 2017-12-14 (M8 to M20) and ETA 18/0185, issue 2018-05-14 (M24 to M30)

Embedment depth and base material thickness

Anchor size		M8	M10	M12	M16	M20	M24	M27	M30
HAS									
Eff. Anchorage depth	h_{ef} [mm]	80	90	110	125	170	210	240	270
Base material thickness	h_{min} [mm]	110	120	140	160	220	270	300	340
HIS-N									
Eff. Anchorage depth	h_{ef} [mm]	90	110	125	170	205	-	-	-
Base material thickness	h_{min} [mm]	120	150	170	230	270	-	-	-

Hammer drilled holes and hammer drilled holes with hollow drill bit¹⁾:
Characteristic resistance

Anchor size		M8	M10	M12	M16	M20	M24	M27	M30
Non-cracked concrete									
Tension N_{Rk}	HAS-(E) 5.8	18,9	30,1	43,4	70,6	111,9	153,7	-	-
	HAS-(E) 8.8	24,1	42,2	58,3	70,6	111,9	153,7	187,8	224,0
	HAS-(E-)R	23,2	37,0	53,3	70,6	111,9	153,7	187,8	224,0
	HAS-(E-)HCR	24,1	42,2	58,3	70,6	111,9	153,7	-	-
	HIS-N 8.8	25,0	46,0	67,0	111,9	116,0	-	-	-
	HIS-RN 70	26,0	41,0	59,0	110,0	148,2	-	-	-
Shear V_{Rk}	HAS-(E) 5.8	9,5	15,1	21,7	41,1	56,1	80,1	-	-
	HAS-(E) 8.8	13,3	21,1	30,5	57,7	89,7	128,2	173,5	210,7
	HAS-(E-)R	11,6	18,5	26,7	50,5	78,5	112,2	108,4	131,7
	HAS-(E-)HCR	13,3	21,1	30,5	57,7	89,7	112,2	-	-
	HIS-N 8.8	13,0	23,0	34,0	63,0	58,0	-	-	-
	HIS-RN 70	13,0	20,0	30,0	55,0	83,0	-	-	-
Cracked concrete									
Tension N_{Rk}	HAS-(E) 5.8	10,1	24,0	35,2	50,3	79,8	109,6	-	-
	HAS-(E) 8.8	10,1	24,0	35,2	50,3	79,8	109,6	133,9	159,7
	HAS-(E-)R	10,1	24,0	35,2	50,3	79,8	109,6	133,9	159,7
	HAS-(E-)HCR	10,1	24,0	35,2	50,3	79,8	109,6	-	-
	HIS-N 8.8	23,0	37,1	50,3	79,8	105,7	-	-	-
	HIS-RN 70	23,0	37,1	50,3	79,8	105,7	-	-	-
Shear V_{Rk}	HAS-(E) 5.8	9,5	15,1	21,7	41,1	56,1	80,1	-	-
	HAS-(E) 8.8	13,3	21,1	30,5	57,7	89,7	128,2	173,5	210,7
	HAS-(E-)R	11,6	18,5	26,7	50,5	78,5	112,2	108,4	131,7
	HAS-(E-)HCR	13,3	21,1	30,5	57,7	89,7	112,2	-	-
	HIS-N 8.8	13,0	23,0	34,0	63,0	58,0	-	-	-
	HIS-RN 70	13,0	20,0	30,0	55,0	83,0	-	-	-

1) Hilti hollow drill bit is available for the element sizes M12 to M20.

Design resistance

Anchor size		M8	M10	M12	M16	M20	M24	M27	M30
Non-cracked concrete									
Tension N_{Rd}	HAS-(E) 5.8	12,6	20,1	28,9	47,1	74,6	102,5	-	-
	HAS-(E) 8.8	16,1	28,1	38,8	47,1	74,6	102,5	125,2	149,4
	HAS-(E-)JR	13,8	22,0	31,7	47,1	74,6	102,5	75,8	92,1
	HAS-(E-)HCR	16,1	28,1	38,8	47,1	74,6	102,5	-	-
	HIS-N 8.8	16,7	30,7	44,7	74,6	77,3	-	-	-
	HIS-RN 70	13,9	21,9	31,6	58,8	69,2	-	-	-
Shear V_{Rd}	HAS-(E) 5.8	7,6	12,1	17,4	32,9	44,9	64,1	-	-
	HAS-(E) 8.8	10,6	16,9	24,4	46,2	71,8	102,6	138,8	168,6
	HAS-(E-)JR	8,3	13,2	19,1	36,1	50,3	71,9	45,5	55,3
	HAS-(E-)HCR	10,6	16,9	24,4	46,2	71,8	64,1	-	-
	HIS-N 8.8	10,4	18,4	27,2	50,4	46,4	-	-	-
	HIS-RN 70	8,3	12,8	19,2	35,3	41,5	-	-	-
Cracked concrete									
Tension N_{Rd}	HAS-(E) 5.8	6,7	16,0	23,5	33,5	53,2	73,0	-	-
	HAS-(E) 8.8	6,7	16,0	23,5	33,5	53,2	73,0	89,2	106,5
	HAS-(E-)JR	6,7	16,0	23,5	33,5	53,2	73,0	75,8	92,1
	HAS-(E-)HCR	6,7	16,0	23,5	33,5	53,2	73,0	-	-
	HIS-N 8.8	15,3	24,7	33,5	53,2	70,4	-	-	-
	HIS-RN 70	13,9	21,9	31,6	53,2	70,4	-	-	-
Shear V_{Rd}	HAS-(E) 5.8	7,6	12,1	17,4	32,9	44,9	64,1	-	-
	HAS-(E) 8.8	10,6	16,9	24,4	46,2	71,8	102,6	138,8	168,6
	HAS-(E-)JR	8,3	13,2	19,1	36,1	50,3	71,9	45,5	55,3
	HAS-(E-)HCR	10,6	16,9	24,4	46,2	71,8	64,1	-	-
	HIS-N 8.8	10,4	18,4	27,2	50,4	46,4	-	-	-
	HIS-RN 70	8,3	12,8	19,2	35,3	41,5	-	-	-

1) Hilti hollow drill bit is available for the element sizes M12 to M20.

Recommended loads²⁾

Anchor size		M8	M10	M12	M16	M20	M24	M27	M30
Non-cracked concrete									
Tension N_{Rec}	HAS-(E) 5.8	9,0	14,3	20,7	33,6	53,3	73,2	-	-
	HAS-(E) 8.8	11,5	20,1	27,7	33,6	53,3	73,2	89,4	106,7
	HAS-(E-)JR	9,9	15,7	22,7	33,6	53,3	73,2	54,2	65,8
	HAS-(E-)HCR	11,5	20,1	27,7	33,6	53,3	73,2	-	-
	HIS-N 8.8	11,9	21,9	31,9	53,3	55,2	-	-	-
	HIS-RN 70	9,9	15,7	22,5	42,0	49,4	-	-	-
Shear V_{Rec}	HAS-(E) 5.8	5,4	8,6	12,4	23,5	32,1	45,8	-	-
	HAS-(E) 8.8	7,6	12,1	17,4	33,0	51,3	73,3	99,1	120,4
	HAS-(E-)JR	5,9	9,4	13,6	25,8	35,9	51,4	32,5	39,5
	HAS-(E-)HCR	7,6	12,1	17,4	33,0	51,3	45,8	-	-
	HIS-N 8.8	7,4	13,1	19,4	36,0	33,1	-	-	-
	HIS-RN 70	6,0	9,2	13,7	25,2	29,6	-	-	-
Cracked concrete									
Tension N_{Rec}	HAS-(E) 5.8	4,8	11,4	16,8	24,0	38,0	52,2	-	-
	HAS-(E) 8.8	4,8	11,4	16,8	24,0	38,0	52,2	63,7	76,1
	HAS-(E-)JR	4,8	11,4	16,8	24,0	38,0	52,2	54,2	65,8
	HAS-(E-)HCR	4,8	11,4	16,8	24,0	38,0	52,2	-	-
	HIS-N 8.8	10,9	17,6	24,0	38,0	50,3	-	-	-
	HIS-RN 70	9,9	15,7	22,5	38,0	49,4	-	-	-
Shear V_{Rec}	HAS-(E) 5.8	5,4	8,6	12,4	23,5	32,1	45,8	-	-
	HAS-(E) 8.8	7,6	12,1	17,4	33,0	51,3	73,3	99,1	120,4
	HAS-(E-)JR	5,9	9,4	13,6	25,8	35,9	51,4	32,5	39,5
	HAS-(E-)HCR	7,6	12,1	17,4	33,0	51,3	45,8	-	-
	HIS-N 8.8	7,4	13,1	19,4	36,0	33,1	-	-	-
	HIS-RN 70	6,0	9,2	13,7	25,2	29,6	-	-	-

1) Hilti hollow drill bit is available for the element sizes M12-M20.

2) With overall partial safety factor for action $\gamma = 1,4$. The partial safety factors for action depend on the type of loading and shall be taken from national regulations.

Diamond cored holes:
Characteristic resistance

Anchor size		M8	M10	M12	M16	M20	M24	M27	M30
Non-cracked concrete									
Tension N_{Rk}	HAS-(E) 5.8	-	30,1	43,4	70,6	111,9	153,7	-	-
	HAS-(E) 8.8	-	39,6	58,1	70,6	111,9	153,7	187,8	224,0
	HAS-(E-) R	-	37,0	53,3	70,6	111,9	153,7	187,8	224,0
	HAS-(E-) HCR	-	39,6	58,1	70,6	111,9	153,7	-	-
	HIS-N 8.8	25,0	46,0	67,0	111,9	116,0	-	-	-
	HIS-RN 70	26,0	41,0	59,0	110,0	148,2	-	-	-
Shear V_{Rk}	HAS-(E) 5.8	-	15,1	21,7	41,1	56,1	80,1	-	-
	HAS-(E) 8.8	-	21,1	30,5	57,7	89,7	128,2	173,5	210,7
	HAS-(E-) R	-	18,5	26,7	50,5	78,5	112,2	108,4	131,7
	HAS-(E-) HCR	-	21,1	30,5	57,7	89,7	112,2	-	-
	HIS-N 8.8	13,0	23,0	34,0	63,0	58,0	-	-	-
	HIS-RN 70	13,0	20,0	30,0	55,0	83,0	-	-	-
Cracked concrete									
Tension N_{Rk}	HAS-(E) 5.8	-	19,8	29,0	44,0	74,8	109,6	-	-
	HAS-(E) 8.8	-	19,8	29,0	44,0	74,8	109,6	133,9	159,7
	HAS-(E-) R	-	19,8	29,0	44,0	74,8	109,6	133,9	159,7
	HAS-(E-) HCR	-	19,8	29,0	44,0	74,8	109,6	-	-
	HIS-N 8.8	15,9	25,7	36,2	61,0	80,0	-	-	-
	HIS-RN 70	15,9	25,7	36,2	61,0	80,0	-	-	-
Shear V_{Rk}	HAS-(E) 5.8	-	15,1	21,7	41,1	56,1	80,1	-	-
	HAS-(E) 8.8	-	21,1	30,5	57,7	89,7	128,2	173,5	210,7
	HAS-(E-) R	-	18,5	26,7	50,5	78,5	112,2	108,4	131,7
	HAS-(E-) HCR	-	21,1	30,5	57,7	89,7	112,2	-	-
	HIS-N 8.8	13,0	23,0	34,0	63,0	58,0	-	-	-
	HIS-RN 70	13,0	20,0	30,0	55,0	83,0	-	-	-

Design resistance

Anchor size		M8	M10	M12	M16	M20	M24	M27	M30
Non-cracked concrete									
Tension N_{Rd}	HAS-(E) 5.8	-	20,1	28,9	47,1	74,6	102,5	-	-
	HAS-(E) 8.8	-	26,4	38,7	47,1	74,6	102,5	125,2	149,4
	HAS-(E-) R	-	22,0	31,7	47,1	74,6	102,5	75,8	92,1
	HAS-(E-) HCR	-	26,4	38,7	47,1	74,6	102,5	-	-
	HIS-N 8.8	16,7	30,7	44,7	74,6	77,3	-	-	-
	HIS-RN 70	13,9	21,9	31,6	58,8	69,2	-	-	-
Shear V_{Rd}	HAS-(E) 5.8	-	12,1	17,4	32,9	44,9	64,1	-	-
	HAS-(E) 8.8	-	16,9	24,4	46,2	71,8	102,6	138,8	168,6
	HAS-(E-) R	-	13,2	19,1	36,1	50,3	71,9	45,5	55,3
	HAS-(E-) HCR	-	16,9	24,4	46,2	71,8	64,1	-	-
	HIS-N 8.8	10,4	18,4	27,2	50,4	46,4	-	-	-
	HIS-RN 70	8,3	12,8	19,2	35,3	41,5	-	-	-
Cracked concrete									
Tension N_{Rd}	HAS-(E) 5.8	-	13,2	19,4	29,3	49,8	73,0	-	-
	HAS-(E) 8.8	-	13,2	19,4	29,3	49,8	73,0	89,2	106,5
	HAS-(E-) R	-	13,2	19,4	29,3	49,8	73,0	75,8	92,1
	HAS-(E-) HCR	-	13,2	19,4	29,3	49,8	73,0	-	-
	HIS-N 8.8	10,6	17,1	24,2	40,7	53,3	-	-	-
	HIS-RN 70	10,6	17,1	24,2	40,7	53,3	-	-	-
Shear V_{Rd}	HAS-(E) 5.8	-	12,1	17,4	32,9	44,9	64,1	-	-
	HAS-(E) 8.8	-	16,9	24,4	46,2	71,8	102,6	138,8	168,6
	HAS-(E-) R	-	13,2	19,1	36,1	50,3	71,9	45,5	55,3
	HAS-(E-) HCR	-	16,9	24,4	46,2	71,8	64,1	-	-
	HIS-N 8.8	10,4	18,4	27,2	50,4	46,4	-	-	-
	HIS-RN 70	8,3	12,8	19,2	35,3	41,5	-	-	-

Recommended loads ^{a)}

Anchor size		M8	M10	M12	M16	M20	M24	M27	M30
Non-cracked concrete									
Tension N_{Rec}	HAS-(E) 5.8	-	14,3	20,7	33,6	53,3	73,2	-	-
	HAS-(E) 8.8	-	18,8	27,6	33,6	53,3	73,2	89,4	106,7
	HAS-(E-) R	-	15,7	22,7	33,6	53,3	73,2	54,2	65,8
	HAS-(E-) HCR	-	18,8	27,6	33,6	53,3	73,2	-	-
	HIS-N 8.8	11,9	21,9	31,9	53,3	55,2	-	-	-
	HIS-RN 70	9,9	15,7	22,5	42,0	49,4	-	-	-
Shear V_{Rec}	HAS-(E) 5.8	-	8,6	12,4	23,5	32,1	45,8	-	-
	HAS-(E) 8.8	-	12,1	17,4	33,0	51,3	73,3	99,1	120,4
	HAS-(E-) R	-	9,4	13,6	25,8	35,9	51,4	32,5	39,5
	HAS-(E-) HCR	-	12,1	17,4	33,0	51,3	45,8	-	-
	HIS-N 8.8	7,4	13,1	19,4	36,0	33,1	-	-	-
	HIS-RN 70	6,0	9,2	13,7	25,2	29,6	-	-	-
Cracked concrete									
Tension N_{Rec}	HAS-(E) 5.8	-	9,4	13,8	20,9	35,6	52,2	-	-
	HAS-(E) 8.8	-	9,4	13,8	20,9	35,6	52,2	63,7	76,1
	HAS-(E-) R	-	9,4	13,8	20,9	35,6	52,2	54,2	65,8
	HAS-(E-) HCR	-	9,4	13,8	20,9	35,6	52,2	-	-
	HIS-N 8.8	7,6	12,2	17,3	29,1	38,1	-	-	-
	HIS-RN 70	7,6	12,2	17,3	29,1	38,1	-	-	-
Shear V_{Rec}	HAS-(E) 5.8	-	8,6	12,4	23,5	32,1	45,8	-	-
	HAS-(E) 8.8	-	12,1	17,4	33,0	51,3	73,3	99,1	120,4
	HAS-(E-) R	-	9,4	13,6	25,8	35,9	51,4	32,5	39,5
	HAS-(E-) HCR	-	12,1	17,4	33,0	51,3	45,8	-	-
	HIS-N 8.8	7,4	13,1	19,4	36,0	33,1	-	-	-
	HIS-RN 70	6,0	9,2	13,7	25,2	29,6	-	-	-

a) With overall partial safety factor for action $\gamma = 1,4$. The partial safety factors for action depend on the type of loading and shall be taken from national regulations.

Seismic resistance

All data in this section applies to:

- Hammer drilled holes and hammer drilled holes with hollow drill bit (HAS M10 to M30)
- Correct setting (See setting instruction)
- No edge distance and spacing influence
- *Steel* failure
- Minimum base material thickness
- Concrete C20/25, $f_{ck,cube} = 25 \text{ N/mm}^2$
- $\alpha_{gap} = 0,5$
- Temperature range I: -40 °C to +40 °C
(max. long term temperature +24 °C and max. short term temperature +40 °C)
- All data given in this section according ETA-18/0184, issue 2018-08-17

Embedment depth and base material thickness

Anchor size	M8	M10	M12	M16	M20	M24	M27	M30
HAS								
Eff. Anchorage depth h_{ef} [mm]	80	90	110	125	170	210	240	270
Base material thickness h_{min} [mm]	110	120	140	160	220	270	300	340

Characteristic resistance

Anchor size	M8	M10	M12	M16	M20	M24	M27	M30	
Seismic performance C1									
Tension $N_{Rk,seis}$ [kN]	HAS-(E) 5.8	-	24,0	35,2	42,8	67,8	93,1	-	-
	HAS-(E) 8.8	-	24,0	35,2	42,8	67,8	93,1	113,8	135,8
	HAS-(E)-R	-	24,0	35,2	42,8	67,8	93,1	113,8	135,8
	HAS-(E)-HCR	-	24,0	35,2	42,8	67,8	93,1	-	-
Shear $V_{Rk,seis}$ [kN]	HAS-(E) 5.8	-	11,0	15,0	27,0	43,0	62,0	-	-
	HAS-(E) 8.8	-	16,0	24,0	44,0	69,0	99,0	129,0	157,0
	HAS-(E)-R	-	14,0	21,0	39,0	60,0	87,0	81,0	98,0
	HAS-(E)-HCR	-	16,0	24,0	44,0	69,0	87,0	-	-
Seismic performance C2									
Tension $N_{Rd,seis}$ HAS-(E) 8.8	-	-	-	18,2	27,8	-	-	-	
Shear $V_{Rd,seis}$ HAS-(E) 8.8	-	-	-	40,0	71,0	-	-	-	

Design resistance

Anchor size	M8	M10	M12	M16	M20	M24	M27	M30	
Seismic performance C1									
Tension $N_{Rd,seis}$ [kN]	HAS-(E) 5.8	-	16,0	23,5	28,5	45,2	62,1	-	-
	HAS-(E) 8.8	-	16,0	23,5	28,5	45,2	62,1	75,8	90,5
	HAS-(E)-R	-	16,0	23,5	28,5	45,2	62,1	75,8	90,5
	HAS-(E)-HCR	-	16,0	23,5	28,5	45,2	62,1	-	-
Shear $V_{Rd,seis}$ [kN]	HAS-(E) 5.8	-	8,8	12,0	21,6	34,4	49,6	-	-
	HAS-(E) 8.8	-	12,8	19,2	35,2	55,2	79,2	103,2	125,6
	HAS-(E)-R	-	10,0	15,0	27,9	38,5	55,8	34,0	41,2
	HAS-(E)-HCR	-	12,8	19,2	35,2	55,2	49,7	-	-
Seismic performance C2									
Tension $N_{Rd,seis}$ HAS-(E) 8.8	-	-	-	12,1	18,5	-	-	-	
Shear $V_{Rd,seis}$ HAS-(E) 8.8	-	-	-	32,0	56,8	-	-	-	

Fire resistance

All data in this section applies to:

- Correct setting (See setting instruction)
- No edge distance and spacing influence
- Steel failure
- Minimum base material thickness
- Concrete C20/25, $f_{ck,cube} = 25 \text{ N/mm}^2$
- All data given in this section according to Fire test assessment from Ing. Thiele, Pirmasens 21735 / 2017-08-01

Embedment depth and base material thickness

Anchor size		M8	M10	M12	M16	M20	M24	M27	M30
HAS									
Eff. Anchorage depth	h_{ef} [mm]	80	90	110	125	170	210	240	270
Base material thickness	h_{min} [mm]	110	120	140	160	220	270	300	340
HIS-N									
Eff. Anchorage depth	h_{ef} [mm]	90	110	125	170	205	-	-	-
Base material thickness	h_{min} [mm]	120	150	170	230	270	-	-	-

Characteristic/design¹ resistance in uncracked concrete

Anchor size		M8	M10	M12	M16	M20	M24	M27	M30
Fire Exposure R30									
Tension $N_{Rk,fi}$	HAS-(E) 8.8	1,83	2,90	4,22	7,85	12,2	17,6	23,0	28,0
	HAS-(E)-R	4,19	6,64	9,65	17,1	28,0	40,4	52,5	64,2
	HIS-N 8.8	1,83	2,90	4,22	7,85	12,2	-	-	-
	HIS-RN 70	4,19	6,64	9,65	18,0	28,0	-	-	-
Shear $V_{Rk,fi}$	HAS-(E) 8.8	1,83	2,90	4,22	7,85	12,2	17,6	23,0	28,0
	HAS-(E)-R	4,19	6,64	9,65	17,1	28,0	40,4	52,5	64,2
	HIS-N 8.8	1,83	2,90	4,22	7,85	12,2	-	-	-
	HIS-RN 70	4,19	6,64	9,65	18,0	28,0	-	-	-
Fire Exposure R120									
Tension $N_{Rk,fi}$	HAS-(E) 8.8	0,28	0,47	1,31	2,22	4,41	6,35	8,26	10,1
	HAS-(E)-R	0,28	0,47	1,31	2,22	7,11	10,2	13,3	16,3
	HIS-N 8.8	0,43	1,02	1,52	2,83	4,41	-	-	-
	HIS-RN 70	0,43	1,02	1,75	4,55	7,11	-	-	-
Shear $V_{Rk,fi}$	HAS-(E) 8.8	0,28	0,47	1,31	2,22	4,41	6,35	8,26	10,1
	HAS-(E)-R	0,28	0,47	1,31	2,22	7,11	10,2	13,3	16,3
	HIS-N 8.8	0,43	1,02	1,52	2,83	4,41	-	-	-
	HIS-RN 70	0,43	1,02	1,75	4,55	7,11	-	-	-

1) The safety factor is $\gamma=1.0$ for all load cases

Characteristic/design¹ resistance in cracked concrete

Anchor size		M8	M10	M12	M16	M20	M24	M27	M30
Fire Exposure R30									
Tension $N_{Rk,fi}$	HAS-(E) 8.8	-	2,90	4,22	7,85	12,2	16,6	23,0	28,0
	HAS-(E-)R	-	5,00	9,00	12,8	28,0	40,4	52,5	64,2
	HIS-N 8.8	1,83	2,90	4,22	7,85	12,2	-	-	-
	HIS-RN 70	4,19	6,64	9,65	18,00	28,0	-	-	-
Shear $V_{Rk,fi}$	HAS-(E) 8.8	-	2,90	4,22	7,85	12,2	16,6	23,0	28,0
	HAS-(E-)R	-	5,00	9,00	12,8	28,0	40,4	52,5	64,2
	HIS-N 8.8	1,83	2,90	4,22	7,85	12,2	-	-	-
	HIS-RN 70	4,19	6,64	9,65	18,00	28,0	-	-	-
Fire Exposure R120									
Tension $N_{Rk,fi}$	HAS-(E) 8.8	-	0,35	0,99	1,66	4,40	6,35	8,26	10,1
	HAS-(E-)R	-	0,35	1,00	1,66	6,90	10,2	13,3	16,3
	HIS-N 8.8	0,33	0,76	1,30	2,80	4,40	-	-	-
	HIS-RN 70	0,33	0,76	1,31	4,55	7,11	-	-	-
Shear $V_{Rk,fi}$	HAS-(E) 8.8	-	0,35	0,99	1,66	4,40	6,35	8,26	10,1
	HAS-(E-)R	-	0,35	1,00	1,66	6,90	10,2	13,3	16,3
	HIS-N 8.8	0,33	0,76	1,30	2,80	4,40	-	-	-
	HIS-RN 70	0,33	0,76	1,31	4,55	7,11	-	-	-

1) The safety factor is $\gamma=1.0$ for all load cases

Materials
Mechanical properties for HAS

Anchor size		M8	M10	M12	M16	M20	M24	M27	M30
Nominal tensile strength f_{uk}	HAS-(E) 5.8	570	570	570	570	500	500	-	-
	HAS-(E) 8.8	800	800	800	800	800	800	800	800
	HAS-(E-)R	700	700	700	700	700	700	500	500
	HAS-(E-)HCR	800	800	800	800	800	700	-	-
Yield strength f_{yk}	HAS-(E) 5.8	456	456	456	456	400	400	-	-
	HAS-(E) 8.8	640	640	640	640	640	640	640	640
	HAS-(E-)R	450	450	450	450	450	450	210	210
	HAS-(E-)HCR	640	640	640	640	640	400	-	-
Stressed cross-section A_s	HAS	33,2	52,8	76,2	144,2	224,3	320,5	433,7	526,9
Moment of resistance W	HAS	27,0	54,1	93,8	244,0	474,0	809,0	1274,0	1706,0

Mechanical properties for HIS-N

Anchor size		M8	M10	M12	M16	M20
Nominal tensile strength f_{uk}	HIS-N	490	490	460	460	460
	Screw 8.8 [N/mm ²]	800	800	800	800	800
	HIS-RN	700	700	700	700	700
	Screw 70	700	700	700	700	700
Yield strength f_{yk}	HIS-N	390	390	390	390	390
	Screw 8.8 [N/mm ²]	640	640	640	640	640
	HIS-RN	350	350	350	350	350
	Screw 70	450	450	450	450	450
Stressed cross-section A_s	HIS-(R)N [mm ²]	51,5	108,0	169,1	256,1	237,6
	Screw	36,6	58,0	84,3	157,0	245,0
Moment of resistance W	HIS-(R)N [mm ³]	145	430	840	1595	1543
	Screw	31,2	62,3	109,0	277,0	541,0

Material quality for HAS

Part	Material
Metal parts made of zinc coated steel	
HAS HAS-E	M10 to M24 Strength class 5.8: - Elongation after fracture $A_f > 022$ (equal to $A (l_0 = 5d) > 8\%$ ductile) M10 to M30: Strength class 8.8: - Rupture elongation $A (l_0 = 5d) > 12\%$ ductile - Electroplated zinc coated ($\geq 5 \mu\text{m}$); (F) hot dip galvanized $\geq 45 \mu\text{m}$
Washer	Electroplated zinc coated ($\geq 5 \mu\text{m}$); (F) hot dip galvanized $\geq 45 \mu\text{m}$
Nut	Strength class adapted to strength class of threaded rod. Electroplated zinc coated ($\geq 5 \mu\text{m}$); hot dip galvanized $\geq 45 \mu\text{m}$
Metal parts made of stainless steel	
HAS-R HAS-(E-)-R	M10 to M30 Strength class 70: - Rupture elongation ($l_0=5d$) $> 12\%$ ductile - Stainless steel 1.4401, 1.4404, 1.4578, 1.4571, 1.4438, 1.43362 EN 10088-1:2014
Washer	Stainless steel 1.4401, 1.4404, 1.4578, 1.4571, 1.4439, 1.4362 EN 10088-1:2014
Nut	Strength class adapted to strength class of threaded rod. Stainless steel 1.4401, 1.4404, 1.4578, 1.4571, 1.4439, 1.4362 EN 10088-1:2014
Metal parts made of high corrosion resistant steel	
HAS-HCR HAS-E-HCR	Rupture elongation $A (l_0 = 5d) > 12\%$ ductile High corrosion resistance steel 1.4529, 1.1.4565 EN 10088-1:2014
Washer	High corrosion resistance steel 1.4529, 1.1.4565 EN 10088-1:2014
Nut	Strength class adapted to strength class of threaded rod High corrosion resistance steel 1.4529, 1.1.4565 EN 10088-1:2014

Material quality for HIS-N

Part		Material
Metal parts made of zinc coated steel		
HIS-N	Internal threaded sleeve	C-steel 1.0718; Steel galvanized $\geq 5 \mu\text{m}$
	Screw 8.8	Strength class 8.8, A5 > 8 % Ductile Steel galvanized $\geq 5 \mu\text{m}$
Metal parts made of stainless steel		
HIS-RN	Internal threaded sleeve	Stainless steel 1.4401, 1.4571
	Screw 70	Strength class 70, A5 > 8 % Ductile Stainless steel 1.4401; 1.4404, 1.4578; 1.4571; 1.4439; 1.4362

Setting information

Installation temperature range:

-10°C to +40°C for M8 to M20 under static loading according to ETA-16-0515
 0°C to +40°C for M24 to M30 under static loading according to ETA-18-0185
 0°C to +40°C for M10 to M30 under seismic loading according to ETA-18/0184

In service temperature range

Hilti HVU2 adhesive may be applied in the temperature ranges given below. An elevated base material temperature may lead to a reduction of the design bond resistance.

Temperature range	Base material temperature	Maximum long term base material temperature	Maximum short term base material temperature
Temperature range I	-40 °C to +40 °C	+24 °C	+40 °C
Temperature range II	-40 °C to +80 °C	+50 °C	+80 °C
Temperature range III	-40 °C to +120 °C	+72 °C	+120 °C

Max short term base material temperature

Short-term elevated base material temperatures are those that occur over brief intervals, e.g. as a result of diurnal cycling.

Max long term base material temperature

Long-term elevated base material temperatures are roughly constant over significant periods of time.

Curing time

Temperature of the base material	Minimum curing time t_{cure}
-10 °C to -6 °C ¹⁾	5 hours ¹⁾
-5 °C to -1 °C ¹⁾	3 hours ¹⁾
0 °C to 4 °C	40 min
5 °C to 9 °C	20 min
10 °C to 19 °C	10 min
20 °C to 40 °C	5 min

1) The utilisation of HAS sizes M24, M27 and M30 and HIS size M20 is only allowed for temperatures above 0 °C.

Setting details for HAS

Anchor size	M8	M10	M12	M16	M20	M24	M27	M30	
Foil capsule HVU2	8x80	10x90	12x110	16x125	20x170	24x210	27x240	30x270	
Diameter of element $d_1=d_{nom}$ [mm]	8	10	12	16	20	24	27	30	
Nom. diameter of drill d_0 [mm]	10	12	14	18	22	28	30	35	
Eff. Embedment depth and drill hole in the fixture $h_{ef}=h_0$ [mm]	80	90	110	125	170	210	240	270	
Max. diameter of clearance hole in the fixture d_f [mm]	9	12	14	18	22	26	30	33	
Min. thickness of concrete member h_{min} [mm]	110	120	140	160	220	270	300	340	
Max. torque moment ^{a)} T_{max} [Nm]	10	20	40	80	150	200	270	300	
Min. spacing s_{min} [mm]	40	50	60	75	90	115	120	140	
Min. edge distance c_{min} [mm]	40	45	45	50	55	60	75	80	
Critical spacing for splitting failure $s_{cr,sp}$	$2 C_{cr,sp}$								
Critical edge distance for splitting failure ^{b)} $c_{cr,sp}$ [mm]	$1,0 \cdot h_{ef}$		for $h / h_{ef} \geq 2,0$						
	$4,6 h_{ef} - 1,8 h$		for $2,0 > h/h_{ef} > 1,3$						
	$2,26 h_{ef}$		for $h / h_{ef} \leq 1,3$						
Critical spacing for concrete cone failure $s_{cr,N}$ [mm]	$2 C_{cr,N}$					$3 h_{ef}$			
Critical edge distance for concrete cone $c_{cr,N}$ [mm]	$1,5 h_{ef}$								

For spacing (edge distance) smaller than critical spacing (critical edge distance) the design loads have to be reduced.

- a) Max. recommended torque moment to avoid splitting failure during installation with min. spacing and/or edge distance
- b) h : base material thickness ($h \geq h_{min}$)
- c) The critical edge distance for concrete cone failure depends on the embedment depth h_{ef} and the design bond resistance. The simplified formula given in this table is on the safe side.

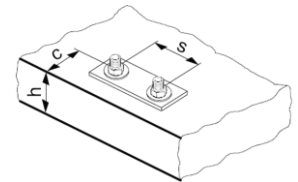

Setting details of HIS-(R)N

Anchor size	M8	M10	M12	M16	M20
Foil capsule HVU2	10x90	12x110	16x125	20x170	24x210
Diameter of element $d_1=d_{nom}$ [mm]	12,5	16,5	20,5	25,4	27,8
Nominal diameter of drill bit d_0 [mm]	14	18	22	28	32
Eff. Embedment depth and drill hole in fixture $h_{ef}=h_0$ [mm]	90	110	125	170	205
Max. diameter of clearance hole in the d_f [mm]	9	12	14	18	22
Min. thickness of concrete member h_{min} [mm]	120	150	170	230	270
Max. torque moment ^{a)} T_{max} [Nm]	10	20	40	80	150
Thread engagement h_s	8-20	10-25	12-30	16-40	20-50
Min. spacing s_{min} [mm]	60	75	90	115	130
Min. edge distance c_{min} [mm]	40	45	55	65	90
Critical spacing for $s_{cr,sp}$	$2 c_{cr,sp}$				
Critical edge distance for splitting failure ^{b)} $c_{cr,sp}$ [mm]	$1,0 \cdot h_{ef}$		for $h / h_{ef} \geq 2,0$		
	$4,6 h_{ef} - 1,8 h$		for $2,0 > h/h_{ef} > 1,3$		
	$2,26 h_{ef}$		for $h / h_{ef} \leq 1,3$		
Critical spacing for concrete cone failure $s_{cr,N}$ [mm]	$2 c_{cr,N}$				$1,5 h_{ef}$
Critical edge distance for concrete cone $c_{cr,N}$ [mm]	$1,5 h_{ef}$				

For spacing (edge distance) smaller than critical spacing (critical edge distance) the design loads have to be reduced.

- a) Max. recommended torque moment to avoid splitting failure during installation with min. spacing and/or edge distance
 b) h : base material thickness ($h \geq h_{min}$)
 c) The critical edge distance for concrete cone failure depends on the embedment depth h_{ef} and the design bond resistance. The simplified formula given in this table is on the safe side.

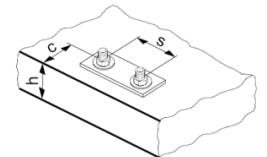

Installation equipment

Anchor size	M8	M10	M12	M16	M20	M24	M27	M30
Rotary hammer	TE 1- TE 7		TE 1- TE 40		TE 50-TE 80			
Drill driver	HAS	SF (H)			-			
	HIS-N	-						
Other tools	Compressed air gun, blow out pump, Hilti hollow drill bit							
	Set of cleaning brushes							

Drilling and cleaning parameters

HAS	HIS-N	Hammer drill	Hollow Drill Bit	Diamond coring	Brush HIT-RB
		d_0 [mm]			
M8	-	10	-	-	-
M10	-	12	-	12	12
M12	M8	14	14	14	14
M16	M10	18	18	18	18
M20	M12	22	22	22	22
M24	M16	28	28	28	28
M27	-	30	-	30	30
-	M20	32	32	32	32
M30	-	35	35	35	35

Setting instructions

*For detailed information on installation see instruction for use given with the package of the product.



Safety regulations.

Review the Material Safety Data Sheet (MSDS) before use for proper and safe handling! Wear well-fitting protective goggles and protective gloves when working with Hilti HVU2.

Hole drilling

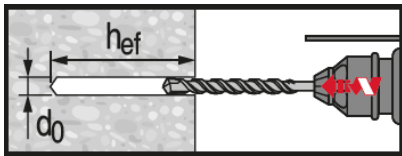

Hammer drilled hole

For dry or wet concrete and installation in flooded holes (no sea water).

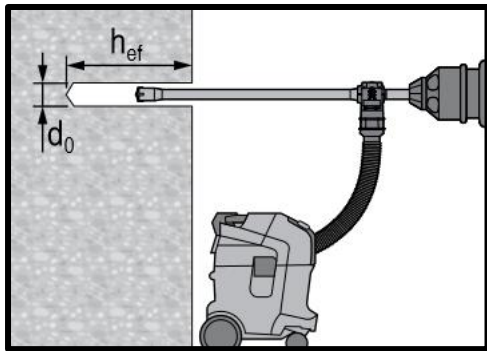

Hammer drilled hole with Hollow drill bit

For dry and wet concrete, only.
No cleaning required.

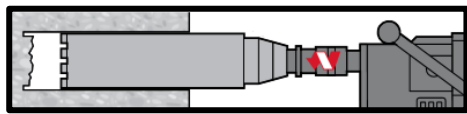

Diamond Coring

For dry and wet concrete only.

Hole cleaning

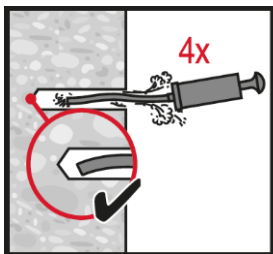

Manual cleaning for hammer drilled hole

for drill diameters $d_0 \leq 18$ mm and drill hole depths $h_0 \leq 10 \cdot d_0$.

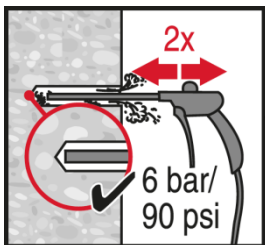

Compressed air cleaning (CAC) for hammer drilled hole

for all drill hole diameters d_0 and drill hole depths h_0 .

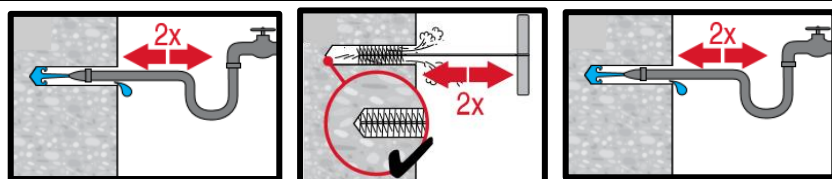

Hammer drilled flooded holes and diamond cored holes:

for all drill hole diameters d_0 and drill hole depths h_0 .

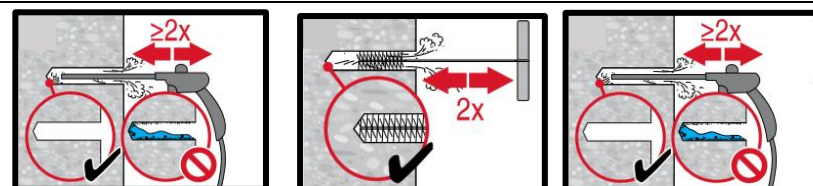

Setting the element

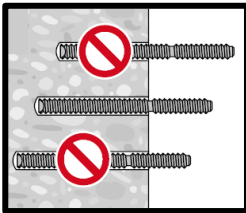
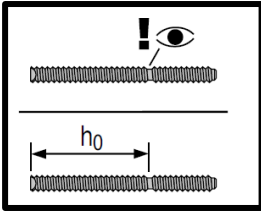

Check the setting depth.

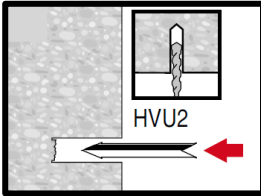

Insert the foil capsule with the peak ahead to the back of the hole.

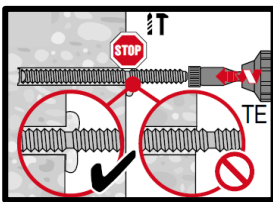

Drive the anchor rod with the plugged tool into the hole.

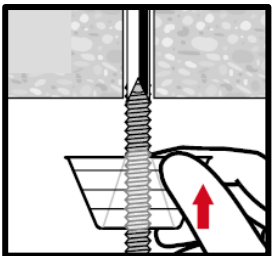
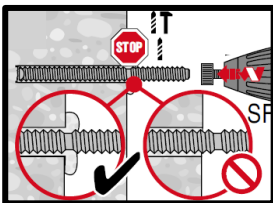

Overhead installation.

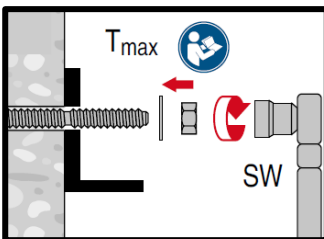

Loading the anchor after required curing time t_{cure} .



HIT-HY 170 injection mortar

Anchor design (ETAG 001) / Rods&Sleeves / Concrete

Chemical anchors Multimerial

Mechanical anchors

Plastic/Light duty metal anchors

Insulation anchors

Injection mortar system



Hilti HIT-HY 170
500 ml foil pack
(also available as
330 ml foil pack)



Anchor rod:
HIT-V
HIT-V-F
HIT-V-R
HIT-V-HCR
(M8-M24)



Internally
threaded sleeve:
HIS-N
HIS-RN
(M8-M16)

Benefits

- Suitable for non-cracked and cracked ^{a)} concrete C 20/25 to C 50/60
- Suitable for dry and water saturated concrete
- Small edge distance and anchor spacing possible
- High corrosion / corrosion resistant
- In service temperature range up to 80°C short term / 50°C long term

a) Applications only with HIT-V anchor rods.

Base material



Concrete (non-cracked)

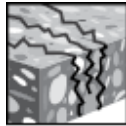

Concrete (cracked) ^{a)}



Dry concrete



Wet concrete

Load conditions

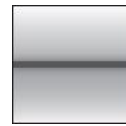

Static/
quasi-static

Installation conditions

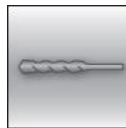

Hammer drilled holes

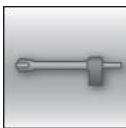

Hollow drill-bit drilling

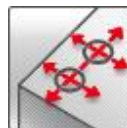

Small edge embedment depth

SAFE-ET

Hilti **SafeSet** technology



European Technical Assessment



CE conformity

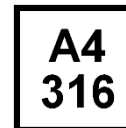

Corrosion resistance



High corrosion resistance ^{a)}

a) Applications only with HIT-V anchor rods.

Approvals / certificates

Description	Authority / Laboratory	No. / date of issue
European technical Approval ^{a)}	DIBt, Berlin, Germany	ETA-14/0457 / 2017-12-14

a) All data given in this section according to ETA-14/0457, issue 2017-12-14.

Basic loading data (for a single anchor)

All data in this section applies to:

- Correct setting (See setting instruction)
- No edge distance and spacing influence
- Steel failure
- Base material thickness as specified in the table
- One typical embedment depth, as specified in the table
- One anchor material, as specified in the tables
- Concrete C 20/25, $f_{ck,cube} = 25 \text{ N/mm}^2$
- Temperature range I (min. base material temp. -40°C , max. long/short term base material temp.: $+24^\circ\text{C}/40^\circ\text{C}$)

Embedment depth ^{a)}

Anchor size			M8	M10	M12	M16	M20	M24
HIT-V								
Embedment depth	h_{ef}	[mm]	80	90	110	125	170	210
Base material thickness	h	[mm]	110	120	140	165	220	270
HIS-N								
Embedment depth	h_{ef}	[mm]	90	110	125	170	-	-
Base material thickness	h	[mm]	120	150	170	230	-	-

a) The allowed range of embedment depth is shown in the setting details.

For hammer drilled holes, hammer drilled holes with Hilti hollow drill bit:

Characteristic resistance

Anchor size			M8	M10	M12	M16	M20	M24
Non-cracked concrete								
Tension N_{Rk}	HIT-V 5.8	[kN]	18,0	28,3	41,5	62,8	106,8	153,7
	HIS-N 8.8		25	46,0	67,0	111,9	-	-
Shear V_{Rk}	HIT-V 5.8	[kN]	9,0	15,0	21,0	39,0	61,0	88,0
	HIS-N 8.8		13,0	23,0	34,0	63,0	-	-
Cracked concrete								
Tension N_{Rk}	HIT-V 5.8	[kN]	-	15,6	22,8	34,6	-	-
Shear V_{Rk}	HIT-V 5.8	[kN]	-	15,0	21,0	39,0	-	-

Design resistance

Anchor size			M8	M10	M12	M16	M20	M24
Non-cracked concrete								
Tension N_{Rd}	HIT-V 5.8	[kN]	12,0	18,8	27,6	41,9	71,2	102,5
	HIS-N 8.8		16,7	30,7	44,7	74,6	-	-
Shear V_{Rd}	HIT-V 5.8	[kN]	7,2	12,0	16,8	31,2	48,8	70,4
	HIS-N 8.8		10,4	18,4	27,2	50,4	-	-
Cracked concrete								
Tension N_{Rd}	HIT-V 5.8	[kN]	-	10,4	15,2	23,0	-	-
Shear V_{Rd}	HIT-V 5.8	[kN]	-	12,0	16,8	31,2	-	-

Recommended loads a)

Anchor size			M8	M10	M12	M16	M20	M24
Non-cracked concrete								
Tension N_{Rec}	HIT-V 5.8	[kN]	8,6	13,5	19,7	29,9	50,9	73,2
	HIS-N 8.8		11,9	21,9	31,9	53,3	-	-
Shear V_{Rec}	HIT-V 5.8	[kN]	5,1	8,6	12,0	22,3	34,9	50,3
	HIS-N 8.8		7,4	13,1	19,4	36,0	-	-
Cracked concrete								
Tension N_{Rec}	HIT-V 5.8	[kN]	-	7,4	10,9	16,5	-	-
Shear V_{Rec}	HIT-V 5.8	[kN]	-	8,6	12,0	22,3	-	-

a) With overall partial safety factor for action $\gamma=1,4$. The partial safety factors for action depend on the type of loading and shall be taken from national regulations.

Materials
Materials properties for HIT-V

Anchor size			M8	M10	M12	M16	M20	M24
Nominal tensile strength f_{uk}	HIT-V 5.8	[N/mm ²]	500	500	500	500	500	500
	HIT-V 8.8		800	800	800	800	800	800
	HIT-V-R		700	700	700	700	700	700
	HIT-V-HCR		800	800	800	800	800	700
Yield strength f_{yk}	HIT-V 5.8	[N/mm ²]	400	400	400	400	400	400
	HIT-V 8.8		640	640	640	640	640	640
	HIT-V-R		450	450	450	450	450	450
	HIT-V-HCR		640	640	640	640	640	400
Stressed cross-section A_s	HIT-V	[mm ²]	36,6	58,0	84,3	157	245	353
Moment of resistance W	HIT-V	[mm ³]	31,2	62,3	109	277	541	935

Mechanical properties for HIS-N

Anchor size			M8	M10	M12	M16
Nominal tensile strength f_{uk}	HIS-N	[N/mm ²]	490	490	490	490
	Screw 8.8		800	800	800	800
	HIS-RN		700	700	700	700
	Screw A4-70		700	700	700	700
Yield strength f_{yk}	HIS-N	[N/mm ²]	390	390	390	390
	Screw 8.8		640	640	640	640
	HIS-RN		350	350	350	350
	Screw A4-70		450	450	450	450
Stressed cross-section A_s	HIS-(R)N	[mm ²]	51,5	108,0	169,1	256,1
	Screw	[mm ²]	36,6	58	84,3	157
Moment of resistance W	HIS-(R)N	[mm ³]	145	430	840	1595
	Screw	[mm ³]	31,2	62,3	109	277

Material quality for HIT-V

Part	Material
Zinc coated steel	
Threaded rod, HIT-V 5.8 (F)	Strength class 5.8; Elongation at fracture A5 > 8% ductile Electroplated zinc coated $\geq 5\mu\text{m}$; (F) hot dip galvanized $\geq 45\mu\text{m}$
Threaded rod, HIT-V 8.8 (F)	Strength class 8.8; Elongation at fracture A5 > 12% ductile Electroplated zinc coated $\geq 5\mu\text{m}$; (F) hot dip galvanized $\geq 45\mu\text{m}$
Hilti Meter rod, AM 8.8 (HDG)	Strength class 8.8; Elongation at fracture A5 > 12% ductile Electroplated zinc coated $\geq 5\mu\text{m}$ (HDG) hot dip galvanized $\geq 45\mu\text{m}$
Washer	Electroplated zinc coated $\geq 5\mu\text{m}$, hot dip galvanized $\geq 45\mu\text{m}$
Nut	Strength class of nut adapted to strength class of threaded rod. Electroplated zinc coated $\geq 5\mu\text{m}$, hot dip galvanized $\geq 45\mu\text{m}$
Stainless Steel	
Threaded rod, HIT-V-R	Strength class 70 for $\leq M24$ and strength class 50 for $> M24$; Elongation at fracture A5 > 8% ductile Stainless steel 1.4401; 1.4404; 1.4578; 1.4571; 1.4439; 1.4362
Washer	Stainless steel 1.4401, 1.4404, 1.4578, 1.4571, 1.4439, 1.4362 EN 10088-1:2014
Nut	Stainless steel 1.4401, 1.4404, 1.4578, 1.4571, 1.4439, 1.4362 EN 10088-1:2014
High corrosion resistant steel	
Threaded rod, HIT-V-HCR	Strength class 80 for $\leq M20$ and class 70 for $> M20$, Elongation at fracture A5 > 8% ductile High corrosion resistance steel 1.4529; 1.4565;
Washer	High corrosion resistant steel 1.4529, 1.4565 EN 10088-1:2014
Nut	High corrosion resistant steel 1.4529, 1.4565 EN 10088-1:2014

Material quality for HIS-N

Part	Material	
HIS-N	Internal threaded sleeve	C-steel 1.0718 / Steel galvanized $\geq 5\mu\text{m}$
	Screw 8.8	Strength class 8.8, A5 > 8 % Ductile / Steel galvanized $\geq 5\mu\text{m}$
HIS-RN	Internal threaded sleeve	Stainless steel 1.4401, 1.4571
	Screw 70	Strength class 70, A5 > 8 % Ductile Stainless steel 1.4401; 1.4404, 1.4578; 1.4571; 1.4439; 1.4362

Setting information

Installation temperature range

-5°C to +40°C

In service temperature range

Hilti HIT-HY 170 injection mortar with anchor rod HIT-V may be applied in the temperature ranges given below. An elevated base material temperature leads to a reduction of the design bond resistance.

Temperature in the base material

Temperature range	Base material temperature	Maximum long term base material temperature	Maximum short term base material temperature
Temperature range I	-40 °C to +40 °C	+24 °C	+40 °C
Temperature range II	-40 °C to +80 °C	+50 °C	+80 °C

Max short term base material temperature

Short-term elevated base material temperatures are those that occur over brief intervals, e.g. as a result of diurnal cycling.

Max long term base material temperature

Long-term elevated base material temperatures are roughly constant over significant periods of time.

Curing and working time ^{a)}

Temperature of the base material	Maximum working time t_{work}	Maximum curing time t_{cure}
$-5\text{ °C} \leq T_{BM} \leq 0\text{ °C}$ ^{a)}	10 min	12 hours
$0\text{ °C} \leq T_{BM} \leq 5\text{ °C}$ ^{a)}	10 min	5 hours
$5\text{ °C} \leq T_{BM} \leq 10\text{ °C}$	8 min	2,5 hours
$10\text{ °C} \leq T_{BM} \leq 20\text{ °C}$	5 min	1,5 hours
$20\text{ °C} \leq T_{BM} \leq 30\text{ °C}$	3 min	45 min
$30\text{ °C} \leq T_{BM} \leq 40\text{ °C}$	2 min	30 min

a) The curing time data are valid for dry base material only. In wet base material the curing times must be doubled.

Setting details for HIT-V

Anchor size		M8	M10	M12	M16	M20	M24
Nominal diameter of drill bit	d_0 [mm]	10	12	14	18	22	28
Diameter of the element	d [mm]	8	10	12	16	20	24
Eff. embedment depth and drill hole depth ^{a)}	$h_{ef,min}$ [mm]	60	60	70	80	90	96
	$h_{ef,ma}$ [mm]	96	120	144	192	240	288
Min. base material thickness	h_{min} [mm]	$h_{ef} + 30\text{ mm} \geq 100\text{ mm}$			$h_{ef} + 2\text{ }d_0$		
Max. diameter of clearance hole in the fixture	d_f [mm]	9	12	14	18	22	26
Max. torque moment ^{b)}	T_{max} [mm]	10	20	40	80	150	200
Min. spacing	S_{min} [mm]	40	50	60	80	100	120
Min. edge distance	C_{min} [mm]	40	50	60	80	100	120
Critical spacing for splitting failure	$S_{cr,sp}$ [mm]	$2\text{ }C_{cr,sp}$					
Critical edge distance for splitting failure ^{c)}	$C_{cr,sp}$ [mm]	$1,0 \cdot h_{ef}$		for $h / h_{ef} \geq 2,00$			
		$4,6\text{ }h_{ef} - 1,8\text{ }h$		for $2,00 > h / h_{ef} > 1,3$			
		$2,26\text{ }h_{ef}$		for $h / h_{ef} \leq 1,3$			
Critical spacing for concrete cone failure	$S_{cr,N}$ [mm]	$2\text{ }C_{cr,sp}$					
Critical edge distance for concrete cone failure ^{d)}	$C_{cr,N}$ [mm]	$1,5\text{ }h_{ef}$					

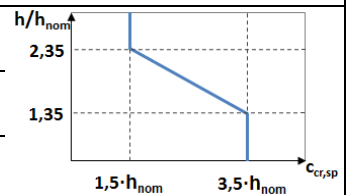

For spacing (edge distance) smaller than critical spacing (critical edge distance) the design loads have to be reduced. $h_{ef,min} \leq h_{ef} \leq h_{ef,max}$ (h_{ef} : embedment depth)

- Maximum recommended torque moment to avoid splitting failure during installation with minimum spacing and edge distance
- h : base material thickness ($h \geq h_{min}$)
- The critical edge distance for concrete cone failure depends on the embedment depth h_{ef} and the design bond resistance. The simplified formula given in this table is on the safe side.

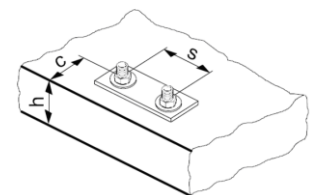

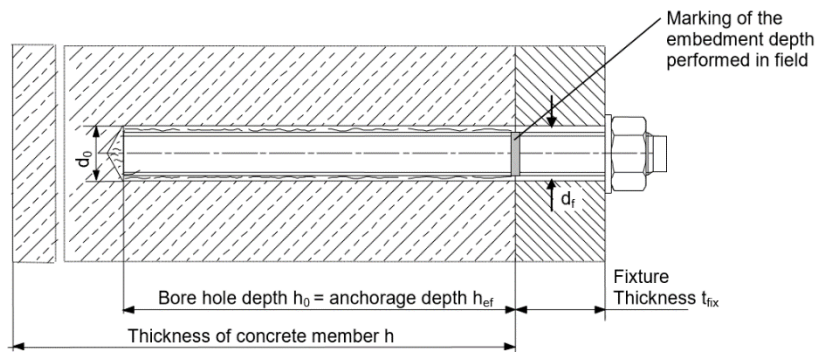

Setting details for HIS-N

Anchor size		M8	M10	M12	M16
Nominal diameter of drill bit	d_0 [mm]	14	18	22	28
Diameter of element	d [mm]	12,5	16,5	20,5	25,4
Eff. embedment depth and drill hole depth ^{a)}	h_{ef} [mm]	90	110	125	170
	h_{min} [mm]	120	150	170	230
Diameter of clearance hole in the fixture	d_f [mm]	9	12	14	18
Thread engagement length min-max	h_s [mm]	8-20	10-25	12-30	16-40
Min. spacing	s_{min} [mm]	60	75	90	115
Min. edge distance	c_{min} [mm]	40	45	55	65
Critical spacing for splitting failure	$s_{cr,sp}$ [mm]	$2 c_{cr,sp}$			
Critical edge distance for splitting failure ^{a)}	$c_{cr,sp}$ [mm]	$1,0 \cdot h_{ef}$ for $h / h_{ef} \geq 2,0$			
		$4,6 h_{ef} - 1,8 h$ for $2,0 > h / h_{ef} > 1,3$			
		$2,26 h_{ef}$ for $h / h_{ef} \leq 1,3$			
Critical spacing for concrete cone failure	$s_{cr,N}$ [mm]	$2 c_{cr,N}$			
Critical edge distance for concrete cone failure ^{b)}	$c_{cr,N}$ [mm]	$1,5 h_{ef}$			
Torque moment ^{c)}	T_{max} [Nm]	10	20	40	80

For spacing (edge distance) smaller than critical spacing (critical edge distance) the design loads have to be reduced.



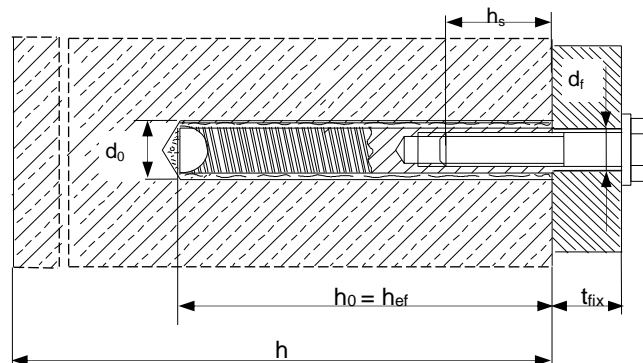



- a) h : base material thickness ($h \geq h_{min}$), h_{ef} : embedment depth
- b) The critical edge distance for concrete cone failure depends on the embedment depth h_{ef} and the design bond resistance. The simplified formula given in this table is on the safe side.
- c) Maximum recommended torque moment to avoid splitting failure during installation with minimum spacing and/or edge distance.



Installation equipment

Anchor size		M8	M10	M12	M16	M20	M24
Rotary hammer	HIT-V	TE 2 (-A) – TE 30 (-A)				TE 40 - TE 80	
	HIS-N	TE 2 (-A) – TE 30 (-A)		TE 40 - TE 80		-	
Other tools		compressed air gun and blow out pump, set of cleaning brushes, dispenser					

Drilling and cleaning parameters

HIT-V	HIS-N	Drill bit diameters d_0 [mm]		Installation size [mm]	
		Hammer drill (HD)	Hollow Drill Bit (HDD)	Brush HIT-RB	Piston plug HIT-SZ
					
M8	-	10	-	10	-
M10	-	12	-	12	12
M12	M8	14	14	14	14
M16	M10	18	18	18	18
M20	M12	22	22	22	22
M24	M16	28	28	28	28

Setting instructions

*For detailed information on installation see instruction for use given with the package of the product



Safety regulations.

Review the Material Safety Data Sheet (MSDS) before use for proper and safe handling! Wear well-fitting protective goggles and protective gloves when working with Hilti HIT-HY 170.

Drilling

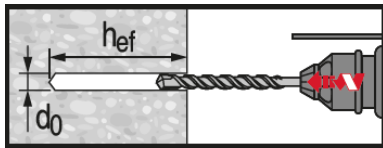

Hammer drilled hole

For dry and wet concrete.

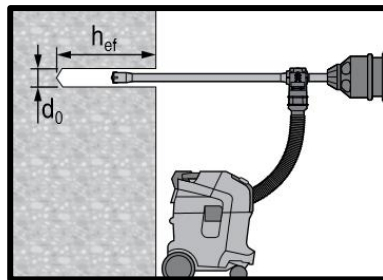

Hammer drilled hole with Hollow Drilled Bit (HDB)

No cleaning required.

Cleaning

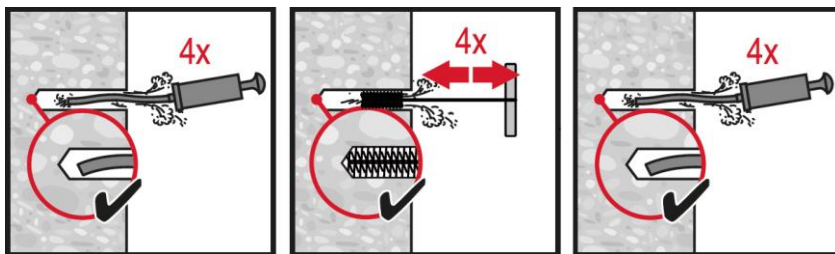

Manual cleaning (MC)

Non-cracked concrete only
for drill diameters $d_0 \leq 18$ mm and drill hole depth $h_0 \leq 10 \cdot d_0$.

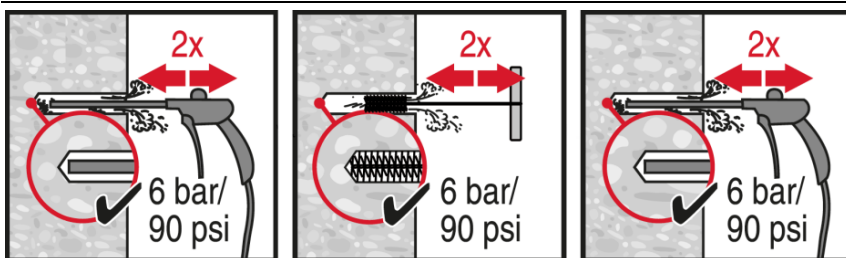

Compressed air cleaning (CAC)

for all drill hole diameters d_0 and drill hole depths h_0 .

Injection

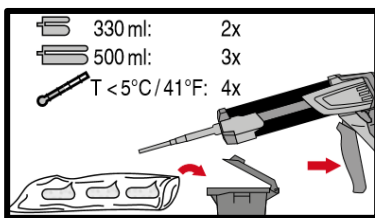
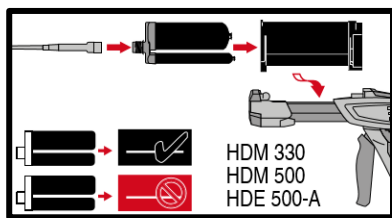

Injection system preparation.

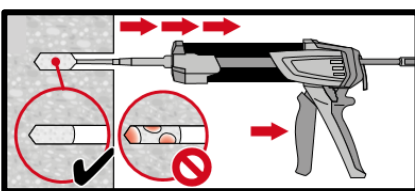
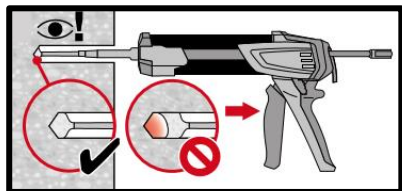

Injection method for drill hole

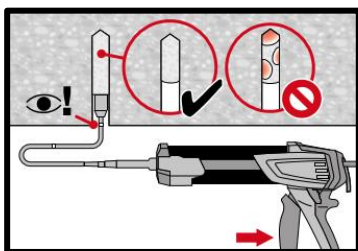
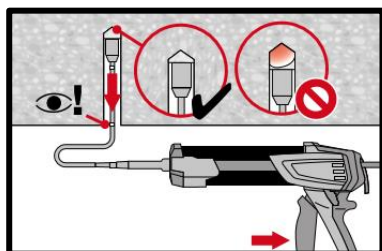

Injection method for overhead application and/or installation with embedment depth $h_{ef} > 250$ mm.

Setting the element

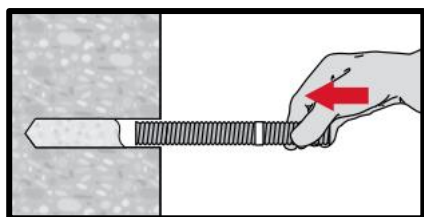

Setting element, observe working time " t_{work} ".

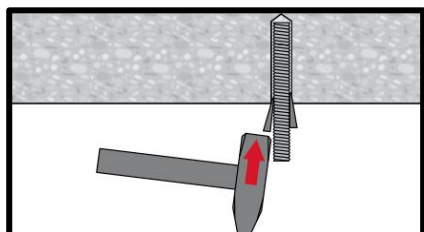

Setting element for overhead applications

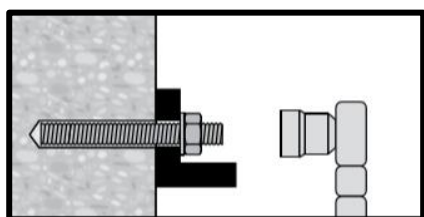

Loading the anchor after required curing time t_{cure}

HIT-HY 170 injection mortar

Anchor design (ETAG 029) / Rods&Sleeves / Masonry

Injection mortar system



Hilti HIT-HY 170

500 ml foil pack
(also available as
330 ml foil pack)



Anchor rod:
HIT-V
HIT-V-F
HIT-V-R
HIT-V-HCR
(M8-M12)



Internally
threaded sleeve:
HIT-IC
(M8-M12)

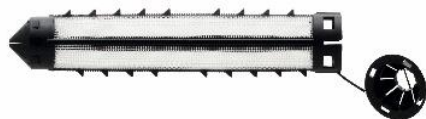

HIT-SC
sieve sleeve
(16-22)

Benefits

- Chemical injection fastening for the most common types of base materials:
- Hollow and solid clay bricks, calcium silicate bricks, normal and light weight concrete blocks
- Two-component hybrid mortar
- Versatile and convenient handling with HDE dispenser
- Mortar filling control with HIT-SC sleeves

Base material

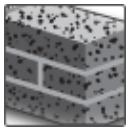

Solid brick

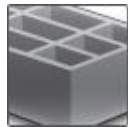

Hollow brick

Load conditions

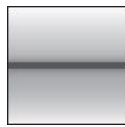

Static/
quasi-static

Installation conditions

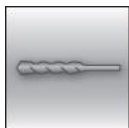

Hammer
drilled holes

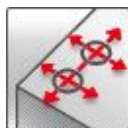

Small edge
embedment
depth

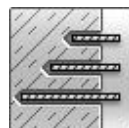

Variable
embedment
depth

Other information



European
Technical
Assessment



CE
conformity

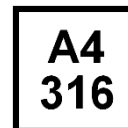

Corrosion
resistance



High
corrosion
resistance



PROFIS
Anchor
design
software

Approvals / certificates

Description	Authority / Laboratory	No. / date of issue
European technical Approval ^{a)}	DIBt, Berlin, Germany	ETA-15/0197 / 2015-12-09

b) All data given in this section according to ETA-15/0197, issue 2015-12-09.

Brick types and properties

Instruction to this technical data

- Identify/choose your brick (or brick type) and its geometrical/physical properties on the following tables. Information about edge and spacing criteria for every brick is available on page 4.
- The pages referred on the last column of the table below contain the design resistance loads for pull-out failure of the anchor, brick breakout failure and local brick failure for each respective brick. Notice that the data displayed on these tables is only valid for single anchors with distance to edge equal to or greater than c_{cr} – for other cases not covered, use PROFIS Anchor software, consult ETA-15/0197 or contact Hilti Engineering Team.
- The resistance loads provided by this technical data manual are valid only for exact same masonry unit (hollow bricks) or for units made of the same base material with equal or higher size and compressive strength (solid bricks). For other cases, on-site tests must be performed—please consult page 8.

Exterior brick dimensions

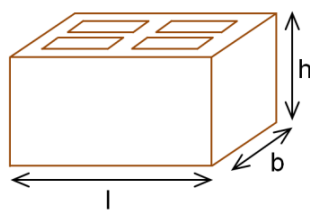

Generic bricks

Interior dimensions of the majority of the holes

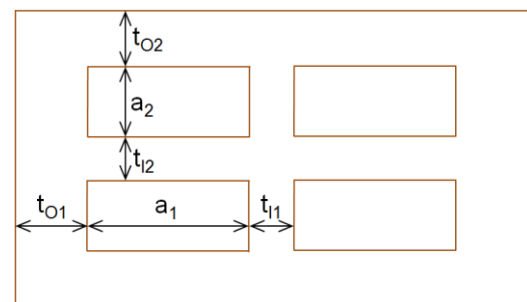

Brick types and properties

Brick code	Data	Brick name	Image	Size [mm]	t_0 [mm]	t_1 [mm]	a [mm]	f_b [N/mm ²]	ρ [kg/dm ³]	Page
Solid Clay										
SC	ETA	Solid clay brick Mz, 2DF		l: ≥ 240 b: ≥ 115 h: ≥ 113	-	-	-	12	2,0	17
Hollow Clay										
HC	ETA	Hollow clay brick Hlz, 10DF		l: 300 b: 240 h: 238	$t_{01}:12$ $t_{02}:15$	$t_{11}:11$ $t_{12}:15$	$a_1: 10$ $a_2: 25$	12/20	1,4	17
Solid Calcium Silicate										
SCS	ETA	Solid silica brick KS, 2DF		l: ≥ 240 b: ≥ 115 h: ≥ 113	-	-	-	12/28	2,0	17
Hollow Calcium Silicate										
HCS	ETA	Hollow silica brick KSL, 8DF		l: 248 b: 240 h: 238	$t_{01}:34$ $t_{02}:21$	$t_{11}:12$ $t_{12}:30$	$a_1: 50$ $a_2: 50$	12/20	1,4	17
Hollow lightweight concrete										
HLWC	ETA	Hollow lightweight concrete brick		l: 495 b: 240 h: 238	$t_{01}:45$ $t_{02}:51$	$t_{11}:35$ $t_{12}:36$	$a_1:196$ $a_2: 52$	2/6	0,8	18
Hollow normal weight concrete										
HNWC	ETA	Hollow normal weight concrete brick		l: 500 b: 200 h: 200	$t_{01}:30$ $t_{02}:15$	$t_{11}:15$ $t_{12}:15$	$a_1:133$ $a_2: 75$	4/10	1,0	18

Anchor installation parameters

Brick position:

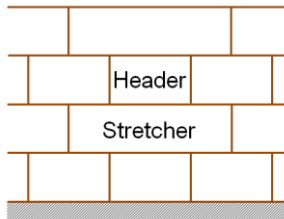

- **Header (H):** The longest dimension of the brick represents the width of the wall
- **Stretcher (S):** The longest dimension of the brick represents the length of the wall

Spacing and edge distance:

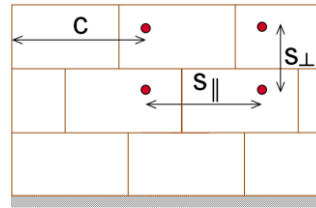

- c - Distance to the edge
- s_{||} - Spacing parallel to the horizontal joint
- s_⊥ - Spacing perpendicular to the horizontal joint

Minimum and characteristic spacing and edge distance parameters

- c_{min} - Minimum edge distance
- c_{cr} - Characteristic edge distance
- s_{min||} - Min. spacing distance parallel to the bed joint
- s_{cr||} - Characteristic spacing distance parallel to the bed joint
- s_{min⊥} - Min. spacing distance perpendicular to the bed joint
- s_{cr⊥} - Characteristic spacing distance perpendicular to the bed joint

Allowed anchor positions:

$$c \geq c_{cr} = c_{min}$$



$$c \geq c_{cr} = c_{min}$$

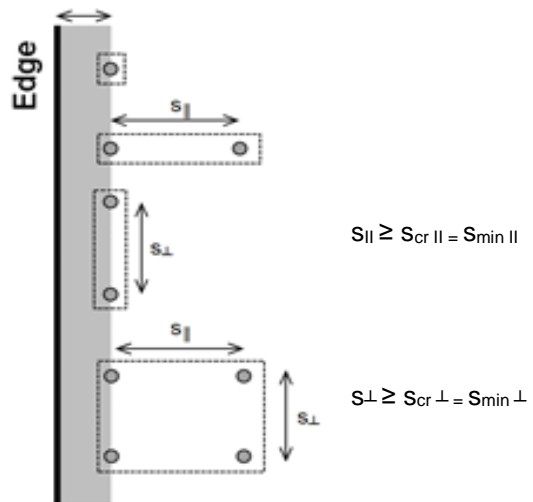

- This FTM includes the load data for single anchors in masonry with a distance to edge equal to or greater than the characteristic edge distance.

$$s_{||} \geq s_{cr||} = s_{min||}$$

$$s_{\perp} \geq s_{cr\perp} = s_{min\perp}$$

Edge and spacing distances per brick

Brick code	$c_{min} = c_{cr}$ [mm]	$s_{min } = s_{cr }$ [mm]	$s_{min\perp} = s_{cr\perp}$ [mm]
SC	115	240	115
HC	150	300	240
SCS	115	240	115
HCS	125	248	240
HLC	250	240	240
HNC	200	200	200

Anchor dimensions

Anchor size		M8	M10	M12
Embedment depth	HIT-V-(R, HCR) h_{ef} [mm]	80		
Embedment depth	HIT-IT h_{ef} [mm]	80		

Design

- Anchorages are designed under the responsibility of an engineer experienced in anchorages and masonry work.
- Verifiable calculation notes and drawings are prepared taking account of the loads to be anchored. The position of the anchor is indicated on the design drawings (e.g. position of the anchor relative to supports, etc.).
- Anchorages under static or quasi-static loading are designed in accordance with: ETAG 029, Annex C, Design method A.

Basic loading data (for a single anchor)

The load tables provide the design resistance load for a single loaded anchor.

All data in this section applies to:

- Edge distance $c \geq c_{cr} = c_{min}$.
- Correct anchor setting (see instruction for use, setting details)

Anchorages subject to:		Hilti HIT-HY 170 with HIT-V or HIT-IC	
Masonry		in solid bricks	in hollow bricks
Hole drilling		hammer mode	rotary mode
Use category: dry or wet structure		Category d/d - Installation and use in structures subject to dry internal conditions. Category w/d - Installation in dry or wet substrate and use in structures subject to dry , internal conditions. Category w/w - Installation and use in structures subject to dry or wet environmental conditions.	
Installation direction		horizontal	
Use category		b (solid masonry)	c (hollow or perforated masonry)
Temperature in the base material at installation		+5° C to +40° C	-5° C to +40° C
In-service temperature	Temperature range Ta:	-40 °C to +40°C	(max. long term temperature +24°C and max. short term temperature +40 °C)
	Temperature range Tb:	-40 °C to +80°C	(max. long term temperature +50°C and max. short term temperature +80 °C)

Tension loading

The design tensile resistance is the lower value of

- Steel resistance: $N_{Rd,s}$
- Pull-out of the anchor: $N_{Rd,p}$
- Brick breakout failure: $N_{Rd,b}$
- Pull out of one brick $N_{Rd,pb}$

Shear loading

The design shear resistance is the lower value of

- Steel resistance: $V_{Rd,s}$
- Local brick failure: $V_{Rd,b}$
- Pushing out of one brick: $V_{Rd,pb}$

Design tension and shear resistances – Steel failure for HIT-V

Anchor size		M8	M10	M12
Tension $N_{Rd,s}$	HIT-V 5.8(F)	12,2	19,3	28,1
	HIT-V 8.8(F)	19,5	30,9	44,9
	HIT-V-R	13,7	21,7	31,6
	HIT-V-HCR	19,5	30,9	44,9
Shear $V_{Rd,s}$	HIT-V 5.8(F)	7,4	11,6	16,9
	HIT-V 8.8(F)	11,7	18,6	27,0
	HIT-V-R	8,2	13,0	18,9
	HIT-V-HCR	11,7	18,6	27,0
$M^0_{Rd,s}$	HIT-V 5.8(F)	15,0	29,9	52,4
	HIT-V 8.8(F)	24,0	47,8	83,8
	HIT-V-R	16,9	33,6	59,0
	HIT-V-HCR	24,0	47,8	83,8

Design tension and shear resistances – Steel failure for internally threaded sleeves HIT-IC

Anchor size		M8	M10	M12
Tension $N_{Rd,s}$	HIT-IC [kN]	3,9	4,8	9,1
Shear $V_{Rd,s}$	HIT-IC [kN]	7,4	11,6	16,9
	Screw 8.8 [kN]	11,7	18,6	27,0
$M^0_{Rd,s}$	HIT-IC [Nm]	15,0	29,9	52,4
	Screw 8.8 [Nm]	24,0	47,8	83,8

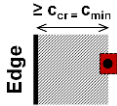

Design tension and shear resistances – Pull-out failure of the anchor, brick breakout failure and local brick failure at characteristic edge distance ($c \geq c_{cr} = c_{min}$) for single anchor applications

Load type	Anchor size	h_{ef} [mm]	f_b [N/mm ²]	w/w and w/d		d/d		
				Ta	Tb	Ta	Tb	
Loads [kN]								
SC - Solid clay brick Mz, 2DF								
$N_{Rd,p} = N_{Rd,b}$ ($c_{cr} = c_{min} = 115\text{mm}$)	HIT-V	M8, M10, M12	80	12	1,2	1,0	1,2	1,0
	HIT-IC	M8			1,2	1,0	1,2	1,0
	HIT-IC	M10, M12			1,6	1,4	1,6	1,4
	HIT-V + HIT-SC	M8, M10, M12			1,6	1,4	1,6	1,4
	HIT-IC + HIT-SC	M8, M10, M12			1,6	1,4	1,6	1,4
$V_{Rd,b}$ ($c_{cr} = c_{min} = 115\text{mm}$)	HIT-V HIT-V + HIT-SC HIT-IC HIT-IC + HIT-SC	M8, M10, M12 M8, M10, M12 M8, M10, M12 M8, M10, M12	80	12	1,4			
HC - Hollow clay brick Hlz, 10DF								
$N_{Rd,p} = N_{Rd,b}$ ($c_{cr} = c_{min} = 150\text{mm}$)	HIT-V + HIT-SC	M8, M10, M12	80	12	1,2	1,0	1,2	1,0
	HIT-IC + HIT-SC	M8, M10, M12		20	1,4	1,2	1,4	1,2
$V_{Rd,b}$ ($c_{cr} = c_{min} = 150\text{mm}$)	HIT-V + HIT-SC	M8, M10, M12	80	12	0,8			
	HIT-IC + HIT-SC	M8, M10, M12		20	1,2			
SCS - Solid silica brick KS, 2DF								
$N_{Rd,p} = N_{Rd,b}$ ($c_{cr} = c_{min} = 115\text{mm}$)	HIT-V	M8, M10, M12	80	12	2,2	2,0	2,4	2,0
	HIT-IC	M8, M10, M12		28	3,4	3,0	3,4	3,0
	HIT-V + HIT-SC	M8, M10, M12		12	1,6	1,4	2,2	2,0
	HIT-IC + HIT-SC	M8, M10, M12		28	2,4	2,2	3,2	3,0
$V_{Rd,b}$ ($c_{cr} = c_{min} = 115\text{mm}$)	HIT-V HIT-V + HIT-SC	M8, M10, M12 M8, M10, M12	80	12	1,6			
	HIT-IC HIT-IC + HIT-SC	M8, M10, M12 M8, M10, M12		28	2,4			
HCS - Hollow silica brick KSL, 8DF								
$N_{Rd,p} = N_{Rd,b}$ ($c_{cr} = c_{min} = 125\text{mm}$)	HIT-V + HIT-SC	M8, M10, M12	80	12	1,2	1,0	1,4	1,2
	HIT-IC + HIT-SC	M8, M10, M12		20	1,6	1,4	2,0	1,8
$V_{Rd,b}$ ($c_{cr} = c_{min} = 125\text{mm}$)	HIT-V + HIT-SC	M8, M10, M12	80	12	3,4			
	HIT-IC + HIT-SC	M8, M10, M12		20	4,8			

Load type	Anchor size	h_{ef} [mm]	f_b [N/mm ²]	w/w and w/d		d/d	
				Ta	Tb	Ta	Tb
Loads [kN]							
HLWC – Hollow lightweight concrete brick HBL, 16DF							
$N_{Rd,p} = N_{Rd,b}$ ($C_{cr} = C_{min} = 250$ mm)	HIT-V + HIT-SC	M8, M10, M12	80	2	0,5	0,4	0,6
	HIT-IC + HIT-SC	M8, M10, M12		6	0,8	0,6	1,0
$V_{Rd,b}$ ($C_{cr} = C_{min} = 250$ mm)	HIT-V + HIT-SC	M8, M10, M12	80	2	1,0		
	HIT-IC + HIT-SC	M8, M10, M12		6	1,6		
HNWC – Hollow normal weight concrete brick Parpaing creux							
$N_{Rd,p} = N_{Rd,b}$ ($C_{cr} = C_{min} = 200$ mm)	HIT-V + HIT-SC	M8, M10, M12	80	4	0,4		
	HIT-IC + HIT-SC	M8, M10, M12		10	0,5	0,6	
$V_{Rd,b}$ ($C_{cr} = C_{min} = 200$ mm)	HIT-V + HIT-SC	M8, M10, M12	80	4	1,0		
	HIT-IC + HIT-SC	M8, M10, M12		10	1,6		

Design tension and shear resistances – Pull out and pushing out of one brick failures

Pull out of one brick (tension):

$$N_{Rd,pb} = 2 \cdot l \cdot b \cdot (0,5 \cdot f_{vko} + 0,4 \cdot \sigma_d) / (2,5 \cdot 1000) \text{ [kN]}$$

$$N_{Rd,pb}^* = (2 \cdot l \cdot b \cdot (0,5 \cdot f_{vko} + 0,4 \cdot \sigma_d) + b \cdot h \cdot f_{vko}) / (2,5 \cdot 1000) \text{ [kN]}$$

* this equation is applicable if the vertical joints are filled

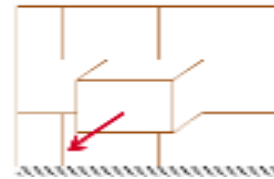

Pushing out of one brick (shear):

$$V_{Rd,pb} = 2 \cdot l \cdot b \cdot (0,5 \cdot f_{vko} + 0,4 \cdot \sigma_d) / (2,5 \cdot 1000) \text{ [kN]}$$

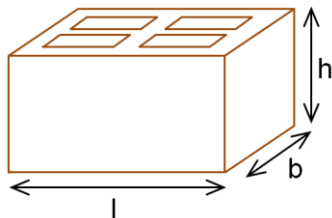
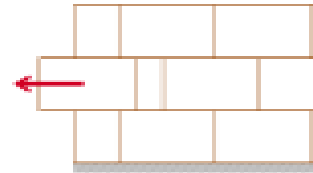

σ_d = design compressive stress perpendicular to the shear (N/mm²)
 f_{vko} = initial shear strength according to EN 1996-1-1, Table 3.4

Brick type	Mortar strength	f_{vko} [N/mm ²]
Clay brick	M2,5 to M9	0,20
	M10 to M20	0,30
All other types	M2,5 to M9	0,15
	M10 to M20	0,20

On-site test



For other bricks in solid or hollow masonry, not covered by the Hilti HIT-HY 170 ETA or this technical data manual, the characteristic resistance may be determined by on-site tension tests (pull-out tests or proof-load tests), according to ETAG029, Annex B.

For the evaluation of test results, the characteristic resistance shall be obtained taking into account the β factor, which considers the different influences of the product.

The β factor for the brick types covered by the Hilti HIT-HY 170 ETA is provided in the following table:

Use categories		w/w and w/d		d/d	
		Ta*	Tb*	Ta*	Tb*
Temperature range					
Base material	Elements				
Solid clay brick	HIT-V or HIT-IC	0,97	0,83	0,97	0,83
	HIT-V + HIT-SC				
	HIT-IC + HIT-SC				
Solid calcium silicate brick	HIT-V or HIT-IC	0,96	0,84	0,97	0,84
	HIT-V + HIT-SC	0,69	0,62	0,91	0,82
	HIT-IC + HIT-SC				
Hollow clay brick	HIT-V + HIT-SC	0,97	0,83	0,97	0,83
	HIT-IC + HIT-SC				
Hollow calcium silicate brick	HIT-V + HIT-SC	0,69	0,62	0,91	0,82
	HIT-IC + HIT-SC				
Hollow lightweight concrete brick	HIT-V + HIT-SC	0,89	0,81	0,97	0,86
	HIT-IC + HIT-SC				
Hollow normal weight concrete brick	HIT-V + HIT-SC	0,97	0,80	0,97	0,80
	HIT-IC + HIT-SC				

*Ta / Tb, w/w and d/d anchorage parameters, as defined on Tables pages 8-9

Applying the β factor from the table above, the characteristic tension resistance N_{Rk} can be obtained. Characteristic shear resistance V_{Rk} can also be directly derived from N_{Rk} . For detailed procedure consult ETAG 029, Annex B.

Materials

Material quality

Part	Material
Threaded rod HIT-V 5.8 (F)	Strength class 5.8, A5 > 8% ductile Steel galvanized $\geq 5\mu\text{m}$; (F) Hot dip galvanized $\geq 45\mu\text{m}$
Threaded rod HIT-V 8.8 (F)	Strength class 8.8, A5 > 8% ductile Steel galvanized $\geq 5\mu\text{m}$; (F) Hot dip galvanized $\geq 45\mu\text{m}$
Threaded rod HIT-V-R	Strength class 70 for $\leq M24$ and class 50 for $> M24$, A5 > 8% ductile Stainless steel 1.4401; 1.4404; 1.4578; 1.4571; 1.4439; 1.4362
Threaded rod HIT-V-HCR	A5 > 8% ductile High corrosion resistant steel 1.4528, 1.4565
Internally threaded sleeve HIT-IC	A5 > 8% ductile Electroplated zinc coated $\geq 5\mu\text{m}$
Washer	Steel galvanized
	Stainless steel 1.4401; 1.4404; 1.4578; 1.4571; 1.4439; 1.4362
	High corrosion resistant steel 1.4529, 1.4565 EN 10088
Hexagon nut	Strength class 8 Electroplated zinc coated $\geq 5\mu\text{m}$ Hot dip galvanized $\geq 45\mu\text{m}$
	Strength class 70 Stainless steel grade A4 1.4401; 1.4404; 1.4578; 1.4571; 1.4439; 1.4362
	Strength class 70, high corrosion resistant steel, 1.4529; 1.4565
Internally threaded sleeve HIT-IC	A5 > 8% ductile Electroplated zinc coated $\geq 5\mu\text{m}$
Sieve sleeve HIT-SC	Frame: Polyfort FPP 20T Sieve: PA6.6 N500/200

Base materials:

- Solid brick masonry. The characteristic resistances are also valid for larger brick sizes and larger compressive strengths of the masonry unit.
- Hollow brick masonry
- Mortar strength class of the masonry: M2,5 at minimum according to EN 998-2: 2010.
- For other bricks in solid masonry and in hollow or perforated masonry, the characteristic resistance of the anchor may be determined by on-site tests according to ETAG 029, Annex B under consideration of the β -factor according to Table page 9.

Setting information

Installation temperature range:

-5°C to +40°C

In service temperature range

Hilti HIT-HY 170 injection mortar may be applied in the temperature ranges given below. An elevated base material temperature may lead to a reduction of the design bond resistance.

Temperature range	Base material temperature	Max. long term base material temperature	Max. short term base material temperature
Temperature range I	-40 °C to + 40 °C	+ 24 °C	+ 40 °C
Temperature range II	-40 °C to + 80 °C	+ 50 °C	+ 80 °C

Max. short term base material temperature

Short term elevated base material temperatures are those that occur over brief intervals, e.g. as a result of diurnal cycling.

Max. long term base material temperature

Long term elevated base material temperatures are roughly constant over significant periods of time.

Working time and curing time

Temperature of the base material	Maximum working time t_{work}	Minimum curing time t_{cure}
$-5\text{ °C} \leq T_{BM} \leq 0\text{ °C}$ ^{a)}	10 min	12 h
$0\text{ °C} \leq T_{BM} \leq 5\text{ °C}$ ^{a)}	10 min	5 h
$5\text{ °C} \leq T_{BM} \leq 10\text{ °C}$	8 min	2,5 h
$10\text{ °C} \leq T_{BM} \leq 20\text{ °C}$	5 min	1,5 h
$20\text{ °C} \leq T_{BM} \leq 30\text{ °C}$	3 min	45 min
$30\text{ °C} \leq T_{BM} \leq 40\text{ °C}$	2 min	30 min

The curing time data are valid for dry base material only. In wet base material the curing times must be doubled.

a) Data valid for hollow bricks only

Installation Parameters

Single sieve sleeve, $50\text{mm} > h_{ef} > 80\text{mm}$

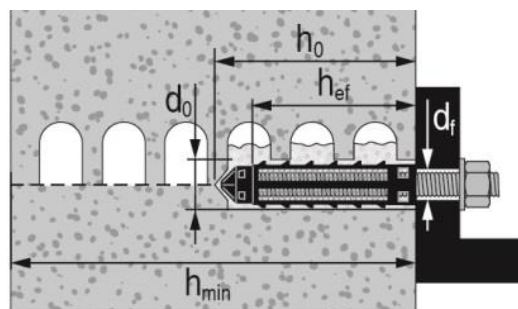

Installation parameters of HIT-V with sieve sleeve HIT-SC in hollow and solid brick

Threaded rods and HIT-V		M8			M10			M12		
		with HIT-SC			16x85			18x85		
Nominal diameter of drill bit	d_0	[mm]	16	16	16	18				
Drill hole depth	h_0	[mm]	95	95	95					
Effective embedment depth	h_{ef}	[mm]	80	80	80					
Maximum diameter of clearance hole in the fixture	d_f	[mm]	9	12	14					
Minimum wall thickness	h_{min}	[mm]	115	115	115					
Brush HIT-RB			16	16	18					
Number of strokes HDM			6	6	8					
Number of strokes HDE 500-			5	5	6					
Maximum torque moment for all brick types except "parpaing creux"	T_{max}	[Nm]	3	4	6					
Maximum torque moment for "parpaing creux"	T_{max}	[Nm]	2	2	3					

Installation parameters of HIT-IC with HIT-SC in hollow and solid brick

HIT-IC		M8	M10	M12
with HIT-SC		16x85	18x85	22x85
Nominal diameter of drill bit	d_0 [mm]	16	18	22
Drill hole depth	h_0 [mm]	95	95	95
Effective embedment depth	h_{ef} [mm]	80	80	80
Thread engagement length	h_s [mm]	8...75	10...75	12...75
Maximum diameter of clearance hole in the fixture	d_f [mm]	9	12	14
Minimum wall thickness	h_{min} [mm]	115	115	115
Brush HIT-RB		16	18	22
Number of strokes HDM		6	8	10
Number of strokes HDE-500		5	6	8
Maximum torque moment	T_{max} [Nm]	3	4	6

Solid bricks without sieve sleeves ^{a)}

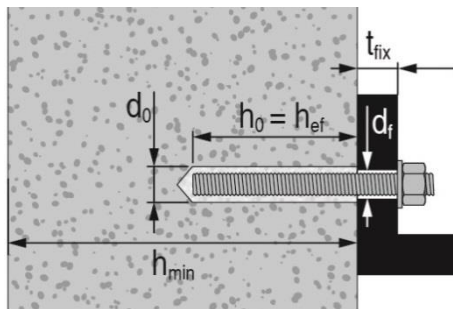

Installation parameters of HIT-V in solid bricks

Threaded rods and HIT-V		M8	M10	M12
Nominal diameter of drill bit	d_0 [mm]	10	12	14
Drill hole depth = Effective embedment depth	$h_0 = h_{ef}$ [mm]	50...300	50...300	50...300
Maximum diameter of clearance hole in the fixture	d_f [mm]	9	12	14
Minimum wall thickness	h_{min} [mm]	h_0+30	h_0+30	h_0+30
Brush HIT-RB		10	12	14
Maximum torque moment	T_{max} [Nm]	5	8	10

a) Hilti recommends the anchoring in masonry always with sieve sleeve. Anchors can only be installed without sieve sleeves in solid bricks when it is guaranteed that it has not any hole or void.

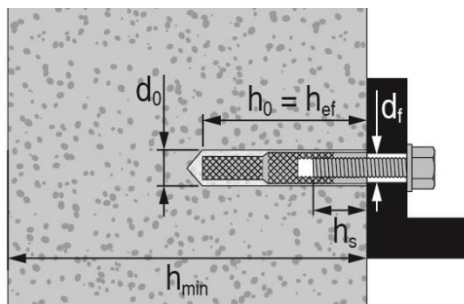

Installation parameters of HIT-IC in solid bricks

HIT-IC		M8x80	M10x80	M12x80
Nominal diameter of drill bit	d_0 [mm]	14	16	18
Drill hole depth = Effective embedment depth	$h_0 = h_{ef}$ [mm]	80	80	80
Thread engagement length	h_s [mm]	8...75	10...75	12...75
Maximum diameter of clearance hole in the fixture	d_f [mm]	9	12	14
Minimum wall thickness	h_{min} [mm]	115	115	115
Brush HIT-RB		14	16	18
Maximum torque moment	T_{max} [Nm]	5	8	10

a) Hilti recommends the anchoring in masonry always with sieve sleeve. Anchors can only be installed without sieve sleeves in solid bricks when it is guaranteed that it has not any hole or void.

Installation equipment

Anchor size	M8	M10	M12
Rotary hammer	TE2(A) – TE30(A)		
Other tools	compressed air gun or blow out pump, set of cleaning brushes, dispenser		

Drilling and cleaning parameters

HIT-V ^{a)}	HIT-V + sieve sleeve	HIT-IC ^{a)}	HIT-IC + sieve sleeve	Hammer drill	Brush HIT-RB	Piston plug HIT-SZ
				d_0 [mm]	size [mm]	
M8	-	-	-	10	10	-
M10	-	-	-	12	12	12
M12	-	M8	-	14	14	14
-	M8	-	-	16	16	16
-	M10	M10	M8	16	16	16
-	M12	M12	M10	18	18	18
-	-	-	M12	22	22	22

a) Installation without the sieve sleeve HIT-SC can be used only in case of solid bricks.

Setting instructions

*For detailed information on installation see instruction for use given with the package of the product.



Safety regulations.

Review the Material Safety Data Sheet (MSDS) before use for proper and safe handling! Wear well-fitting protective goggles and protective gloves when working with Hilti HIT-HY 170.

Drilling

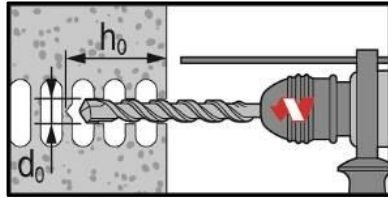

In hollow bricks: rotary mode

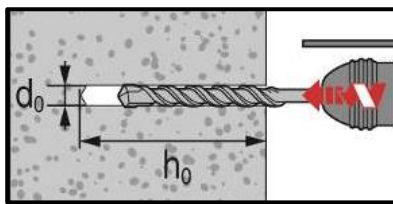

In solid bricks: hammer mode

Cleaning

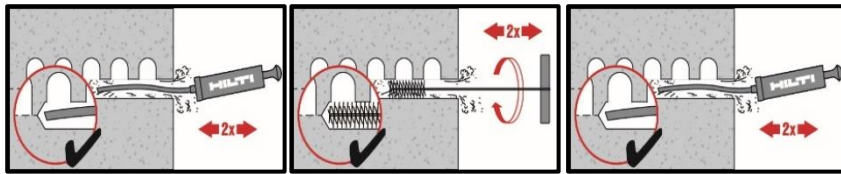

Manual cleaning (MC)

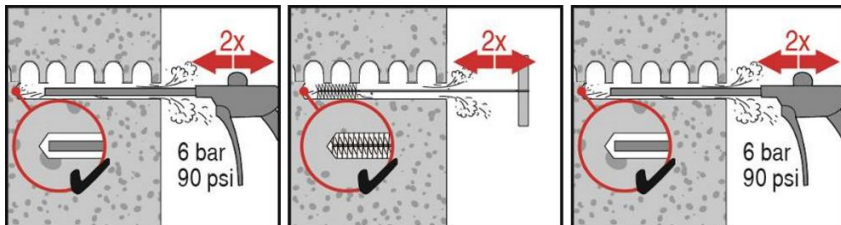

Compressed air cleaning (CAC)

Instructions for solid bricks without sieve sleeve

Injection system

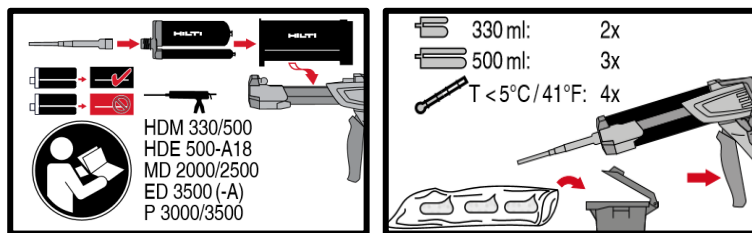

Injection system preparation.

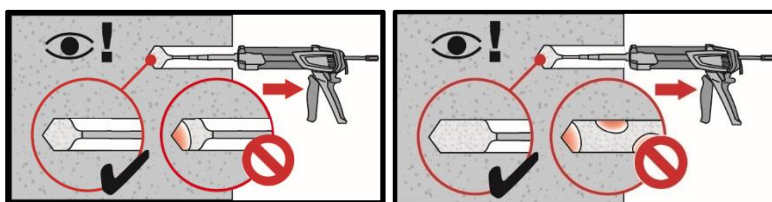

Injection method for drill hole

Setting the element

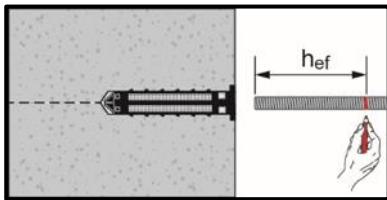

Presetting element, observe working time “ t_{work} ”,

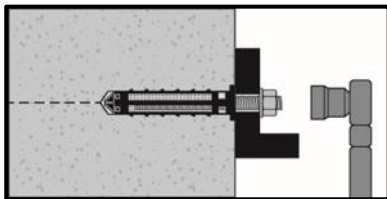

Loading the anchor: After required curing time t_{cure} the anchor can be loaded.

Instructions for hollow and solid bricks with sieve sleeve

Preparation of the sieve sleeve

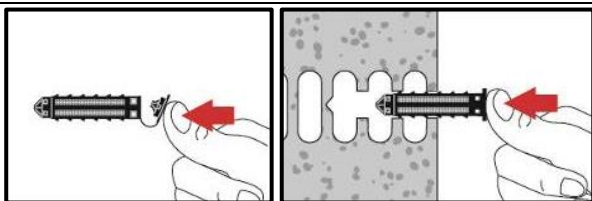

Close lid and insert sieve sleeve manually

Injection system

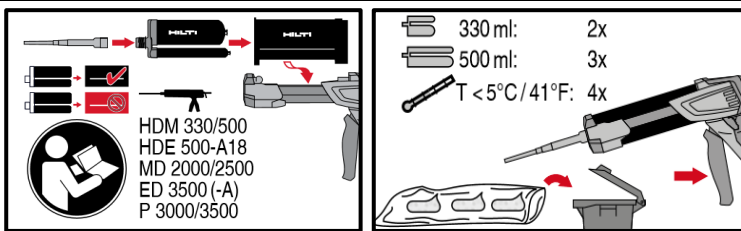

Injection system preparation.

Injection system: hollow bricks

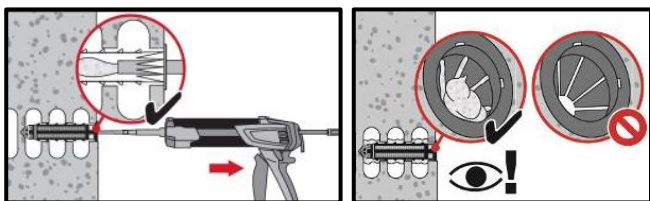

Installation with sieve sleeve HIT-SC

Setting the element

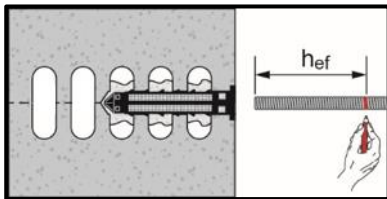

Presetting element, observe working time “ t_{work} ”,

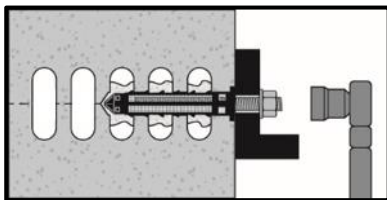

Loading the anchor: After required curing time t_{cure} the anchor can be loaded.



HIT-HY 170 injection mortar

Anchor design (ETAG 001) / Rebar elements / Concrete

Chemical anchors Multimerial

Mechanical anchors

Plastic/Light duty metal anchors

Insulation anchors

Injection mortar system



Hilti HIT-HY 170

500 ml foil pack
(also available as
330 ml foil pack)



Rebar B500 B
($\phi 8$ - $\phi 25$)

Benefits

- Suitable for non-cracked and cracked concrete C 12/15 to C 50/60
- Suitable for dry and water saturated concrete
- High loading capacity and fast cure
- In service temperature range up to 80°C short term/50°C long term
- Manual cleaning for drill hole sizes ≤ 18 mm and embedment depth $h_{ef} \leq 10d$

Base material



Concrete
(non-cracked)



Dry concrete

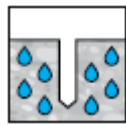

Wet concrete

Load conditions

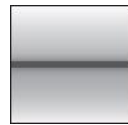

Static/
quasi-static

Installation conditions

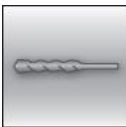

Hammer
drilling

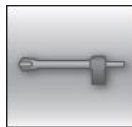

Hollow drill-
bit drilling

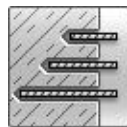

Variable
embedment
depth

Other information

Approvals / certificates

Description	Authority / Laboratory	No. / date of issue
Hilti Technical Data ^{a)}	Hilti	2017-11-28

a) All data given in this section according to Hilti Technical Data.

Static and quasi-static loading (for a single anchor)

All data in this section applies to

- Correct setting
- No edge distance and spacing influence
- Steel failure
- Base material thickness, as specified in the table
- One typical embedment depth, as specified in the table
- One anchor material, as specified in the tables
- Concrete C 20/25, $f_{ck,cube} = 25 \text{ N/mm}^2$
- Temperature range I
(min. base material temperature -40°C , max. long term/short term base material temperature: $+50^\circ\text{C}/80^\circ\text{C}$)

Embedment depth ^{a)} and base material thickness for static and quasi-static loading data

Anchor- size	φ8	φ10	φ12	φ14	φ16	φ18	φ20	φ22	φ24	φ25
Typical embedment depth [mm]	80	90	110	125	145	155	170	185	200	210
Base material thickness [mm]	110	120	140	161	185	199	220	237	256	274

a) The allowed range of embedment depth is shown in the setting details. The corresponding load values can be calculated according to the simplified design method.

Characteristic resistance

Anchor- size	φ8	φ10	φ12	φ14	φ16	φ18	φ20	φ22	φ24	φ25
Tensile N_{Rk}	20,1	28,3	41,5	58,9	72,9	87,7	106,8	127,1	142,8	153,7
Shear V_{Rk}	14,0	22,0	31,0	42,0	55,0	70,0	86,0	104,0	124,0	135,0

Design resistance

Anchor- size	φ8	φ10	φ12	φ14	φ16	φ18	φ20	φ22	φ24	φ25
Tensile N_{Rd}	13,4	18,8	27,6	39,3	48,6	58,4	71,2	84,7	95,2	102,5
Shear V_{Rd}	11,2	17,6	24,8	33,6	44,0	56,0	68,8	83,2	99,2	108,0

Recommended loads ^{a)}

Anchor- size	φ8	φ10	φ12	φ14	φ16	φ18	φ20	φ22	φ24	φ25
Tensile N_{Rec}	9,6	13,5	19,7	28,0	34,7	41,7	50,9	60,5	68,0	73,2
Shear V_{Rec}	8,0	12,6	17,7	24,0	31,4	40,0	49,1	59,4	70,9	77,1

a) With overall partial safety factor for action $\gamma = 1,4$. The partial safety factors for action depend on the type of loading and shall be taken from national regulations.

Materials

Mechanical properties

Anchor size	φ8	φ10	φ12	φ14	φ16	φ18	φ20	φ22	φ24	φ25
Nominal tensile strength f_{uk} [N/mm ²]	550	550	550	550	550	550	550	550	550	550
Yield strength f_{yk} [N/mm ²]	500	500	500	500	500	500	500	500	500	500
Stressed cross-section A_s [mm ²]	50,3	78,5	113,1	153,9	201,1	254,0	314,2	380	452	490,9
Moment of resistance W [mm ³]	50,3	98,2	169,6	269,4	402,1	572,6	785,4	1045,3	1357,2	1534

Material quality

Part	Material
Rebar EN 1992-1-1	Bars and de-coiled rods class B or C with f_{yk} and k according to NDP or NCL of EN 1992-1-1 $f_{uk} = f_{tk} = k \cdot f_{yk}$

Setting information

Installation temperature

-5°C to +40°C

Service temperature range

Hilti HIT-HY 170 injection mortar may be applied in the temperature ranges given below. An elevated base material temperature may lead to a reduction of the design bond resistance.

Temperature range	Base material temperature	Max. long term base material temperature	Max. short term base material temperature
Temperature range I	- 40 °C to + 40 °C	+ 24 °C	+ 40 °C
Temperature range II	- 40 °C to + 80 °C	+ 50 °C	+ 80 °C

Max. short term base material temperature

Short term elevated base material temperatures are those that occur over brief intervals, e.g. as a result of diurnal cycling.

Max. long term base material temperature

Long term elevated base material temperatures are roughly constant over significant periods of time.

Working time and curing time

Temperature of the base material	Max. working time in which rebar can be inserted and adjusted t_{work}	Min. curing time before rebar can be fully loaded t_{cure}
-5 °C ≤ T_{BM} ≤ 0 °C ^{a)}	10 min	12 h
0 °C ≤ T_{BM} ≤ 5 °C ^{a)}	10 min	5 h
5 °C ≤ T_{BM} ≤ 10 °C	8 min	2,5 h
10 °C ≤ T_{BM} ≤ 20 °C	5 min	1,5 h
20 °C ≤ T_{BM} ≤ 30 °C	3 min	45 min
30 °C ≤ T_{BM} ≤ 40 °C	2 min	30 min

The curing time data are valid for dry base material only. In wet base material the curing times must be doubled.

Installation equipment

Rebar – size	Ø8	Ø10	Ø12	Ø14	Ø16	Ø18	Ø20	Ø22	Ø24	Ø25
Rotary hammer	TE2(-A) – TE30(-A)					TE40 – TE80				
Other tools	Blow out pump or Compressed air gun ^{a)} Set of cleaning brushes ^{b)} , dispenser, piston plug									

a) Compressed air gun with extension hose for all drill holes deeper than 250 mm (for ϕ 8 to ϕ 12) or deeper than $20 \cdot \phi$ (for $\phi > 12$ mm)

b) Automatic brushing with round brush for all drill holes deeper than 250 mm (for ϕ 8 to ϕ 12) or deeper than $20 \cdot \phi$ (for $\phi > 12$ mm)

Setting details

Anchor size		Ø8	Ø10	Ø12	Ø14	Ø16	Ø18	Ø20	Ø22	Ø24	Ø25	
Nominal diameter of drill bit	d_0 [mm]	10 / 12 ^{a)}	12 / 14 ^{a)}	14 ^{a)}	16 ^{a)}	18	20	22	25	26	28	32
Effective anchorage and drill hole depth range ^{b)}	$h_{ef,min}$ [mm]	60	60	70	70	75	80	85	90	95	100	100
	$h_{ef,max}$ [mm]	96	120	144	144	168	192	216	240	264	288	300
Minimum base material thickness	h_{min} [mm]	$h_{ef} + 30 \text{ mm}$ $\geq 100 \text{ mm}$				$h_{ef} + 2 d_0$						
Minimum spacing	s_{min} [mm]	40	50	60	60	70	80	90	100	110	120	125
Minimum edge distance	c_{min} [mm]	40	50	60	60	70	80	90	100	110	120	125
Critical spacing for splitting failure	$s_{cr,sp}$ [mm]	$2 C_{cr,sp}$										
Critical edge distance for splitting failure ^{c)}	$C_{cr,sp}$ [mm]	$1,0 \cdot h_{ef}$ for $h / h_{ef} \geq 2,0$										
		$4,6 h_{ef} - 1,8 h$ for $2,0 > h / h_{ef} > 1,3$										
		$2,26 h_{ef}$ for $h / h_{ef} \leq 1,3$										
Critical spacing for concrete cone failure	$s_{cr,N}$ [mm]	$2 C_{cr,N}$										
Critical edge distance for concrete cone failure ^{d)}	$C_{cr,N}$ [mm]	$1,5 h_{ef}$										

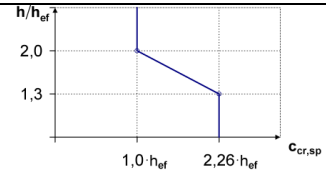

For spacing (edge distance) smaller than critical spacing (critical edge distance) the design loads have to be reduced.

- a) Both given values for drill bit diameter can be used
- b) $h_{ef,min} \leq h_{ef} \leq h_{ef,max}$ (h_{ef} : embedment depth)
- c) h : base material thickness ($h \geq h_{min}$)
- d) The critical edge distance for concrete cone failure depends on the embedment depth h_{ef} and the design bond resistance. The simplified formula given in this table is on the safe side.

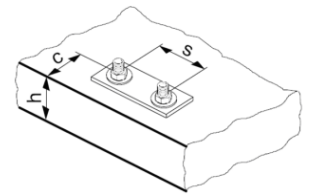

Drilling and cleaning parameters

Rebar	Drill bit diameters d_0 [mm]		Installation size [mm]	
	Hammer drill (HD)	Hollow Drill Bit (HDB)	Brush HIT-RB	Piston plug HIT-SZ
Ø8	10 / 12 ^{a)}	-	10 / 12 ^{a)}	- / 12
Ø10	12 / 14 ^{a)}	14	12 / 14 ^{a)}	12 / 14 ^{a)}
Ø12	14 / 16 ^{a)}	16 (14 ^{a)})	14 / 16 ^{a)}	14 / 16 ^{a)}
Ø14	18	18	18	18
Ø16	20	20	20	20
Ø18	22	22	22	22
Ø20	25	25	25	25
Ø22	28	28	28	28
Ø24	32	32	32	32
Ø25	32	32	32	32

- a) Each of the two given values can be used

Setting instructions

*For detailed information on installation see instruction for use given with the package of the product.



Safety regulations.

Review the Material Safety Data Sheet (MSDS) before use for proper and safe handling! Wear well-fitting protective goggles and protective gloves when working with Hilti HIT-HY 170.

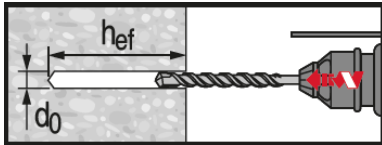

Hammer drilled hole

For dry and wet concrete.

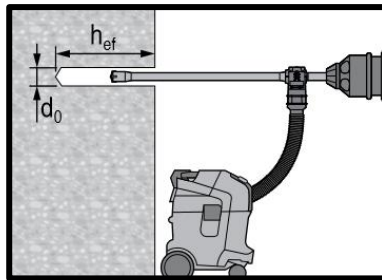

Hammer drilled hole with Hollow Drilled Bit (HDB)

No cleaning required.

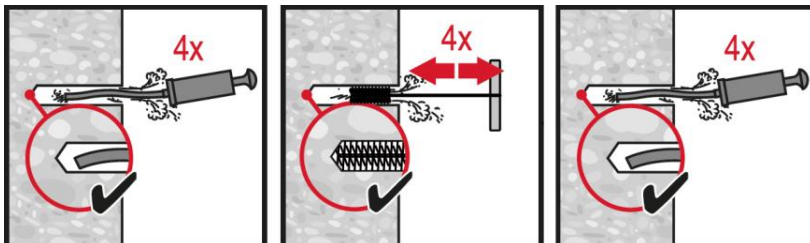

Manual cleaning (MC)

for drill diameters $d_0 \leq 20$ mm and drill hole depth $h_0 \leq 10 \cdot d$.



Compressed air cleaning (CAC)

for all drill hole diameters d_0 and drill hole depths $h_0 \leq 20 \cdot d$.

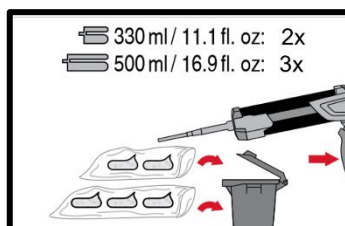
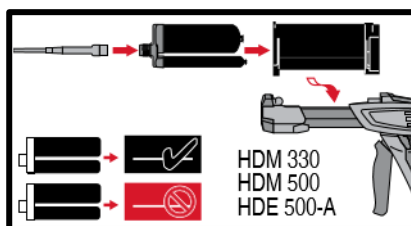

Injection system preparation.

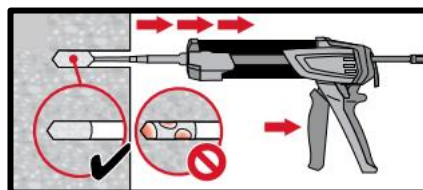
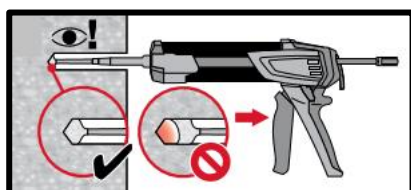

Injection method for drill hole depth

$h_{ef} \leq 250$ mm.

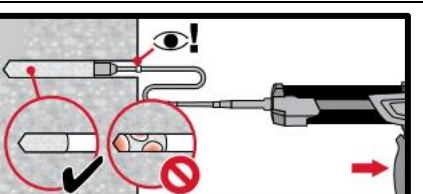
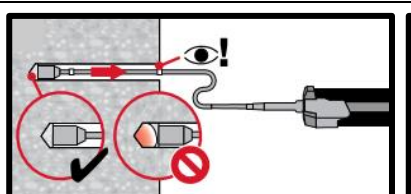

Injection method for drill hole depth

$h_{ef} > 250$ mm.

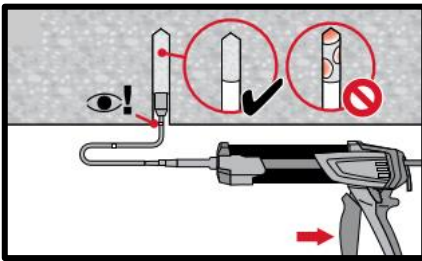
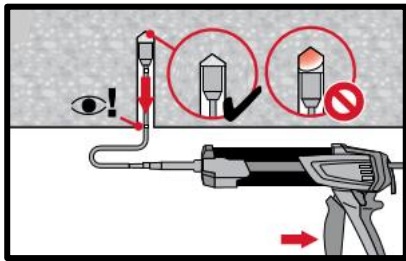

Injection method for overhead application.

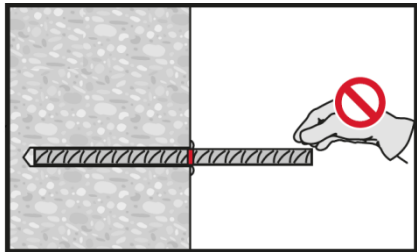
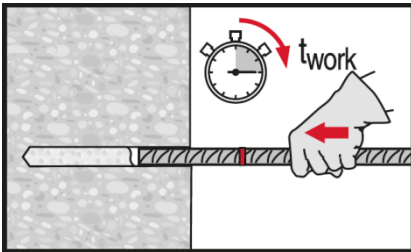

Setting element, observe working time " t_{work} ".

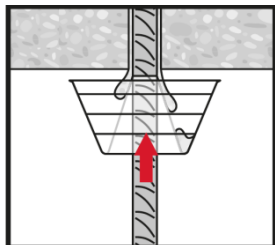
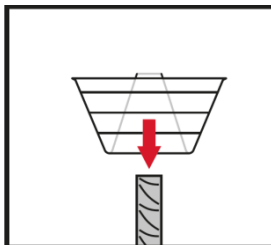
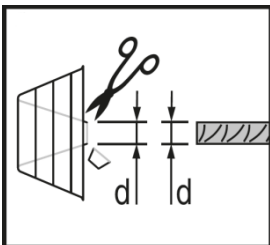

Setting element for overhead applications, observe working time " t_{work} ".

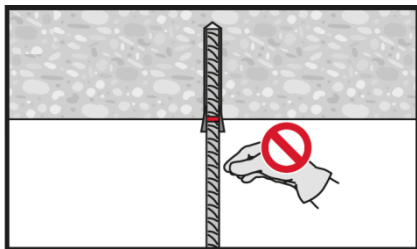
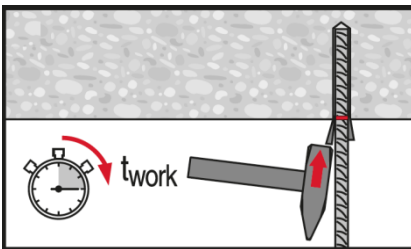

Loading the anchor: After required curing time t_{cure} the anchor can be loaded.

HIT-HY 170 injection mortar

Rebar design (EN 1992-1) / Rebar elements / Concrete

Injection mortar system



Hilti HIT-HY 170
330 ml foil pack

(also available
as 500 ml foil
pack)



Rebar B500 B
(φ8 - φ25)

Benefits

- Suitable for concrete C12/15 to C50/60
- Suitable for dry and water saturated concrete
- High loading capacity and fast cure
- High corrosion resistant
- For rebar diameters up to 25 mm
- Manual cleaning for drill hole sizes ≤ 20 mm and embedment depth $h_{ef} \leq 10d$
- Suitable for embedment depth up to 1000 mm depending on the rebar diameter

Base material



Concrete
(Non-cracked)

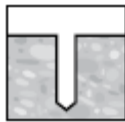

Dry
concrete



Water
saturated
concrete

Load conditions

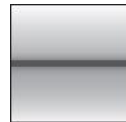

Static/quasi-
static



Fire
resistance

Installation conditions

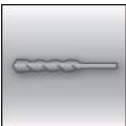

Hammer
drilled holes

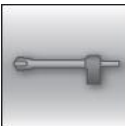

Hollow drill-
bit drilling

Other informations



European
Technical
Assessment



CE
conformity

Approvals / certificates

Description	Authority / Laboratory	No. / date of issue
European Technical Assessment ^{a)}	DIBt, Berlin	ETA-15/0297 / 2015-12-11

b) All data given in this section according to ETA-15/0297 issue 2015-12-11.

Static and quasi-static loading

Design bond strength

Design bond strength in N/mm² accord. to ETA-15/0297 for good bond conditions

All allowed drilling methods									
Rebar - size	Concrete class								
	C12/15	C16/20	C20/25	C25/30	C30/37	C35/45	C40/50	C45/55	C50/60
φ8 - φ12	1,6	2,0	2,3	2,7	3,0	3,4	3,7	3,7	3,7
φ14 - φ25	1,6	2,0	2,3	2,7	3,0	3,4	3,4	3,4	3,4

For all other bond conditions multiply the values by 0,7.

Minimum anchorage length and minimum lap length

The minimum anchorage length $l_{b,min}$ and the minimum lap length $l_{0,min}$ according to EN 1992-1-1 shall be multiplied by the relevant **Amplification factor** α_{lb} in the table below.

Amplification factor α_{lb} for the min. anchorage length and min. lap length according to EN 1992-1-1 for:

All allowed drilling methods									
Rebar - size	Concrete class								
	C12/15	C16/20	C20/25	C25/30	C30/37	C35/45	C40/50	C45/55	C50/60
φ8 - φ25	1,0								

Pre-calculated values

Pre-calculated values¹⁾ – anchorage length

Rebar yield strength $f_{yk}=500$ N/mm², concrete C25/30, good bond conditions

Rebar [mm]	Anchorage length l_{bd} [mm]	Design value N_{Rd} [kN]	Mortar volume ²⁾ V_M [ml]	Anchorage length l_{bd} [mm]	Design value N_{Rd} [kN]	Mortar volume ²⁾ V_M [ml]
	$\alpha_1=\alpha_2=\alpha_3=\alpha_4=\alpha_5=1,0$				$\alpha_1 = \alpha_3 = \alpha_4 = 1,0 \quad \alpha_2 \text{ or } \alpha_5 = 0,7$	
φ8	100	6,8	8	100	9,7	8
	170	11,5	13	140	13,6	11
	250	17,0	19	180	17,4	14
	322	21,9	24	226	21,9	17
φ10	121	10,3	11	121	14,7	11
	220	18,7	20	170	20,6	15
	310	26,3	28	230	27,9	21
	403	34,2	36	281	34,1	25
φ12	145	14,8	15	145	21,1	15
	260	26,5	27	210	30,5	22
	370	37,7	39	270	39,3	29
	483	49,2	51	338	49,1	36
φ14	169	20,1	20	169	28,7	20
	300	35,6	36	240	40,7	29
	430	51,1	52	320	54,3	39
	564	67,0	68	394	66,8	48
φ16	193	26,2	26	193	37,4	26
	340	46,1	46	280	54,3	38
	490	66,5	67	370	71,7	50
	644	87,4	87	451	87,4	61
φ18	217	33,1	33	217	47,3	33
	380	58,0	57	310	67,6	47
	540	82,4	81	410	89,4	62
	700	106,9	106	507	110,6	76
φ20	242	41,1	51	242	58,6	51
	390	66,2	83	350	84,8	74
	550	93,3	117	460	111,5	98
	700	118,8	148	564	136,7	120

Pre-calculated values¹⁾ – anchorage length

Rebar yield strength $f_{yk}=500 \text{ N/mm}^2$, concrete C25/30, good bond conditions

Rebar [mm]	Anchorage length l_{bd} [mm]	Design value N_{Rd} [kN]	Mortar volume ²⁾ V_M [ml]	Anchorage length l_{bd} [mm]	Design value N_{Rd} [kN]	Mortar volume ²⁾ V_M [ml]
	$\alpha_1=\alpha_2=\alpha_3=\alpha_4=\alpha_5=1,0$					
φ22	266	49,6	75	266	70,9	75
	410	76,5	116	380	101,3	107
	560	104,5	158	500	133,3	141
	700	130,6	198	620	165,3	175
φ24	290	59,0	122	290	84,3	122
	430	87,5	182	420	122,1	177
	560	114,0	236	550	160,0	232
	700	142,5	296	676	196,6	285
φ25	302	64,0	114	302	91,5	114
	430	91,2	162	430	130,3	162
	570	120,9	214	570	172,7	214
	700	148,4	263	700	212,1	263

- 1) Values corresponding to the minimum anchorage length. The maximum permissible load is valid for "good bond conditions" as described in EN 1992-1-1. For all other conditions multiply by the value by 0,7.
- 2) The volume of mortar corresponds to the formula " $1,2 \cdot (d_0^2 - d_s^2) \cdot \pi \cdot l_b / 4$ " for hammer drilling

Pre-calculated values¹⁾ – overlap length

Rebar yield strength $f_{yk}=500 \text{ N/mm}^2$, concrete C25/30, good bond conditions

Rebar [mm]	Overlap length l_o [mm]	Design value N_{Rd} [kN]	Mortar volume ²⁾ V_M [ml]	Overlap length l_o [mm]	Design value N_{Rd} [kN]	Mortar volume ²⁾ V_M [ml]
	$\alpha_1=\alpha_2=\alpha_3=\alpha_4=\alpha_5=1,0$					
φ8	200	13,6	15	200	19,4	15
	240	16,3	18	210	20,4	16
	280	19,0	21	220	21,3	17
	322	21,9	24	226	21,9	17
φ10	200	17,0	18	200	24,2	18
	270	22,9	24	230	27,9	21
	340	28,8	31	250	30,3	23
	403	34,2	36	281	34,1	25
φ12	200	20,4	21	200	29,1	21
	290	29,5	31	250	36,4	26
	390	39,7	41	290	42,2	31
	483	49,2	51	338	49,1	36
φ14	210	24,9	25	210	35,6	25
	330	39,2	40	270	45,8	33
	450	53,4	54	330	56,0	40
	564	67,0	68	394	66,8	48
φ16	240	32,6	33	240	46,5	33
	370	50,2	50	310	60,1	42
	510	69,2	69	380	73,7	52
	644	87,4	87	451	87,4	61
φ18	270	41,2	41	270	58,9	41
	410	62,6	62	350	76,3	53
	560	85,5	84	430	93,8	65
	700	106,9	106	507	110,6	76
φ20	300	50,9	64	300	72,7	64
	430	72,9	91	390	94,5	83
	570	96,7	121	480	116,3	102
	700	118,8	148	564	136,7	120
φ22	330	61,6	93	330	88,0	93
	450	84,0	127	430	114,6	122
	580	108,2	164	520	138,6	147
	700	130,6	198	620	165,3	175
φ24	360	73,3	152	360	104,7	152
	470	95,7	198	470	136,7	198
	590	120,1	249	570	165,8	241

Pre-calculated values¹⁾ – overlap length

Rebar yield strength $f_{yk}=500$ N/mm², concrete C25/30, good bond conditions

Rebar [mm]	Overlap length l_0 [mm]	Design value N_{Rd} [kN]	Mortar volume ²⁾ V_M [ml]		Overlap length l_0 [mm]	Design value N_{Rd} [kN]	Mortar volume ²⁾ V_M [ml]
$\phi 25$	700	142,5	296		676	196,6	285
	375	79,5	141		375	113,6	141
	480	101,8	181		480	145,4	181
	590	125,1	222		590	178,7	222
	700	148,4	263		700	212,1	263

- 1) Values corresponding to the minimum anchorage length. The maximum permissible load is valid for “good bond conditions” as described in EN 1992-1-1. For all other conditions multiply by the value by 0,7.
- 2) The volume of mortar corresponds to the formula “ $1,2 \cdot (d_0^2 - d_s^2) \cdot \pi \cdot l_b / 4$ ” for hammer drilling

Materials

Material quality

Part	Material
Rebar EN 1992-1-1	Bars and de-coiled rods class B or C with f_{yk} and k according to NDP or NCL of EN 1992-1-1 $f_{uk} = f_{tk} = k \cdot f_{yk}$

Fitness for use

Some creep tests have been conducted in accordance with ETAG guideline 001 part 5 and TR 023 in the following conditions: **in dry environment at 50 °C during 90 days.**

These tests show an excellent behaviour of the post-installed connection made with HIT-HY 170: low displacements with long term stability, failure load after exposure above reference load.

Resistance to chemical substance

Chemical substance	Comment	Resistance
Sulphuric acid	23°C	+
Alkaline medium	pH = 13,2, 23°C	+

Installation temperature range

-5°C to +40°C

Service temperature range

Hilti HIT-HY 170 injection mortar may be applied in the temperature ranges given below. An elevated base material temperature may lead to a reduction of the design bond resistance.

Temperature range	Base material temperature	Maximum long term base material temperature	Maximum short term base material temperature
Temperature range I	-40 °C to +80 °C	+50 °C	+80 °C

Max short term base material temperature

Short-term elevated base material temperatures are those that occur over brief intervals, e.g. as a result of diurnal cycling.

Max long term base material temperature

Long-term elevated base material temperatures are roughly constant over significant periods of time.

Working time and curing time

Temperature of the base material T_{BM}	Maximum working time t_{gel}	Minimum curing time $t_{cure}^{1)}$
$-5\text{ °C} \leq T_{BM} \leq 0\text{ °C}^a)$	10 min	12 hours
$0\text{ °C} \leq T_{BM} \leq 5\text{ °C}^a)$	10 min	5 hours
$5\text{ °C} \leq T_{BM} \leq 10\text{ °C}$	8 min	2,5 hours
$10\text{ °C} \leq T_{BM} \leq 20\text{ °C}$	5 min	1,5 hours
$20\text{ °C} \leq T_{BM} \leq 30\text{ °C}$	3 min	45 min
$30\text{ °C} \leq T_{BM} \leq 40\text{ °C}$	2 min	30 min

1) The curing time data are valid for dry base material only. In wet base material the curing times must be doubled.

Setting information

Installation equipment

Rebar – size	$\phi 8$	$\phi 10$	$\phi 12$	$\phi 14$	$\phi 16$	$\phi 18$	$\phi 20$	$\phi 22$	$\phi 24$	$\phi 25$
Rotary hammer	TE2(-A) – TE30(-A)					TE40 – TE80				
Other tools	Blow out pump ($h_{ef} \leq 10 \cdot d$)					-				
	Compressed air gun ^{a)} Set of cleaning brushes ^{b)} , dispenser, piston plug									

c) Compressed air gun with extension hose for all drill holes deeper than 250 mm (for $\phi 8$ to $\phi 12$) or deeper than $20 \cdot \phi$ (for $\phi > 12$ mm)

d) Automatic brushing with round brush for all drill holes deeper than 250 mm (for $\phi 8$ to $\phi 12$) or deeper than $20 \cdot \phi$ (for $\phi > 12$ mm)

Minimum concrete cover c_{min} of the post-installed rebar

Drilling method	Bar diameter [mm]	Minimum concrete cover c_{min} [mm]	
		Without drilling aid	With drilling aid
Hammer drilling (HD)	$\phi < 25$	$30 + 0,06 \cdot l_v \geq 2 \cdot \phi$	$30 + 0,02 \cdot l_v \geq 2 \cdot \phi$
	$\phi \geq 25$	$40 + 0,06 \cdot l_v \geq 2 \cdot \phi$	$40 + 0,02 \cdot l_v \geq 2 \cdot \phi$
Compressed air drilling (CA)	$\phi < 25$	$50 + 0,08 \cdot l_v$	$50 + 0,02 \cdot l_v$
	$\phi \geq 25$	$60 + 0,08 \cdot l_v \geq 2 \cdot \phi$	$60 + 0,02 \cdot l_v \geq 2 \cdot \phi$

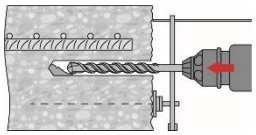





Drilling and cleaning parameters

Rebar	Hammer drilling (HD)	Compressed air drilling (CA)	Brush HIT-RB	Air nozzle HIT-RB
	d_0 [mm]		size [mm]	
				
$\phi 8$	10 ^{a)}	-	10	10
	12	-	12	12
$\phi 10$	12 ^{a)}	-	12	12
	14	-	14	14
$\phi 12$	14 ^{a)}	-	14	14
	16	-	16	16
	-	17	18	16
$\phi 14$	18	-	18	18
	-	17	18	16
$\phi 16$	20	20	20	20
$\phi 18$	22	22	22	22
$\phi 20$	25	-	25	25
	-	26	28	25
$\phi 22$	28	28	28	28
$\phi 24$	32	32	32	32
$\phi 25$	32	32	32	32

a) Maximum installation length $l=250$ mm.

Drilling and cleaning parameters

Rebar	Drill bit diameters d_0 [mm]		Installation size [mm]	
	Hammer drill (HD) 	Hollow Drill Bit (HDB) 	Brush HIT-RB 	Piston plug HIT-SZ 
				
$\phi 8$	10 / 12 ^{a)}	-	10 / 12 ^{a)}	- / 12
$\phi 10$	12 / 14 ^{a)}	14	12 / 14 ^{a)}	12 / 14 ^{a)}
$\phi 12$	14 / 16 ^{a)}	16 (14 ^{a)})	14 / 16 ^{a)}	14 / 16 ^{a)}
$\phi 14$	18	18	18	18
$\phi 16$	20	20	20	20
$\phi 18$	22	22	22	22
$\phi 20$	25	25	25	25
$\phi 22$	28	28	28	28
$\phi 24$	32	32	32	32
$\phi 25$	32	32	32	32

Dispensers and corresponding maximum embedment depth $l_{v,max}$

Rebar	Dispenser HDM 330, HDM 500, HDE 500
	$l_{v,max}$ [mm]
$\phi 8$ to $\phi 16$	1000
$\phi 18$ to $\phi 25$	700

Setting instructions

*For detailed information on installation see instruction for use given with the package of the product.



Safety regulations.

Review the Material Safety Data Sheet (MSDS) before use for proper and safe handling! Wear well-fitting protective goggles and protective gloves when working with Hilti HIT-HY 170.

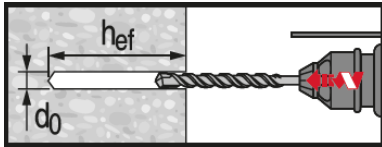

Hammer drilled hole

For dry and wet concrete.

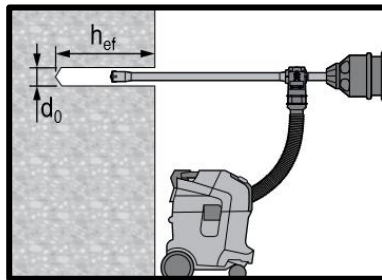

Hammer drilled hole with Hollow Drilled Bit (HDB)

No cleaning required.

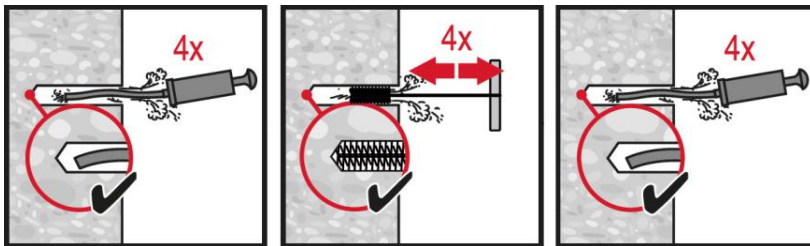

Manual cleaning (MC)

for drill diameters $d_0 \leq 20$ mm and drill hole depth $h_0 \leq 10 \cdot d$.

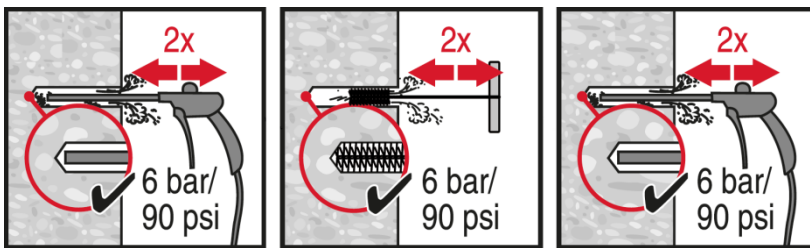

Compressed air cleaning (CAC)

for all drill hole diameters d_0 and drill hole depths $h_0 \leq 20 \cdot d$.

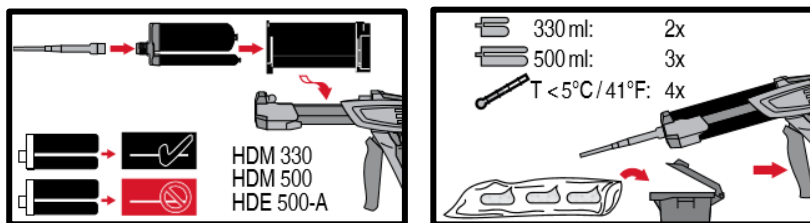

Injection system preparation.

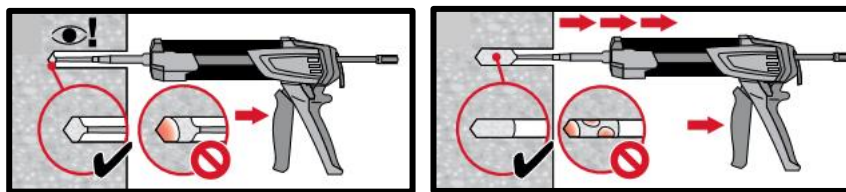

Injection method for drill hole depth $h_{ef} \leq 250$ mm.

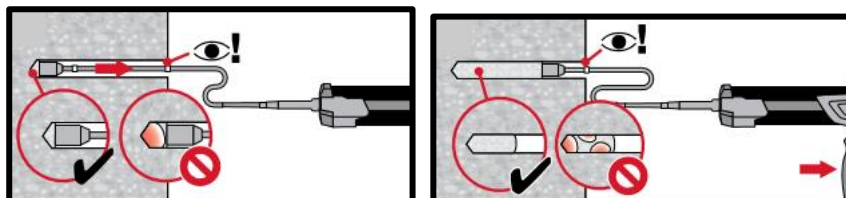

Injection method for drill hole depth $h_{ef} > 250$ mm.

Chemical anchors Multimaterial Mechanical anchors Plastic/Light duty metal anchors Insulation anchors

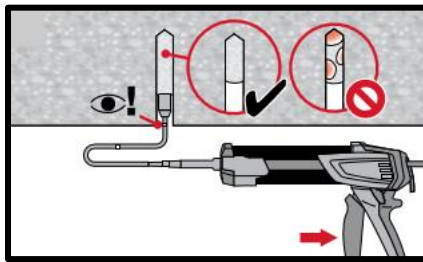
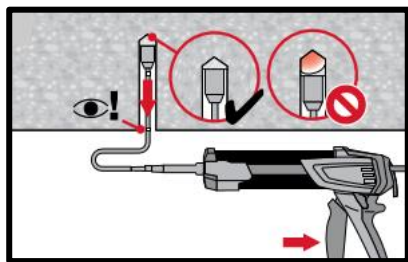

Injection method for overhead application.

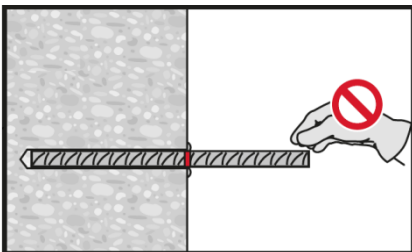
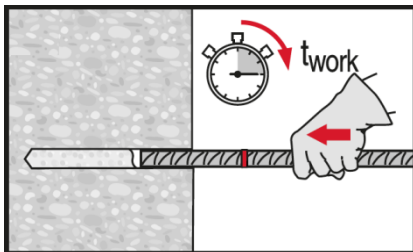

Setting element, observe working time " t_{work} ".

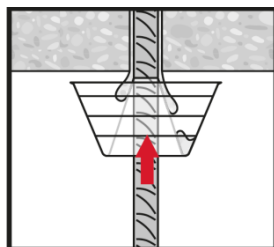
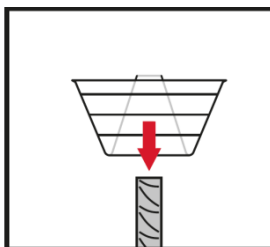
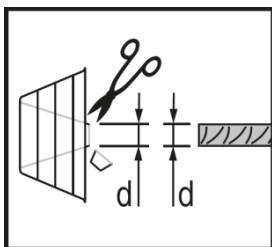

Setting element for overhead applications, observe working time " t_{work} ".

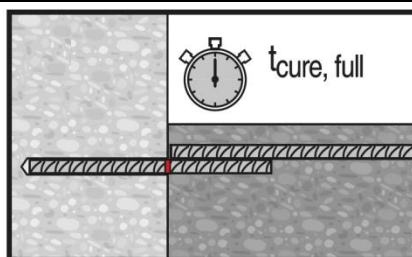
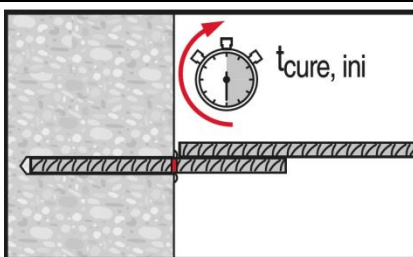
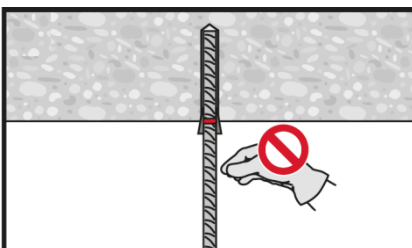
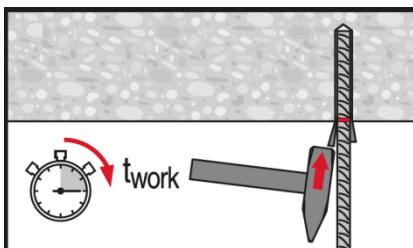

Apply full load only after curing time " t_{cure} ".

HIT-MM Plus injection mortar

Anchor design (ETAG 001) / Rods&Sleeves / Concrete

Injection mortar system



Hilti HIT-MM Plus
300 ml foil pack
(also available as
500 ml foil pack)



Anchor rods:
HIT-V
HIT-V-F
HIT-V-R
(M8-M16)



Anchor rods:
HAS-(E)
HAS-(E)R
(M8-M16)



Internally threaded
sleeves:
HIS-N
(M8-M16)

Benefits

- Chemical injection fastening
- Two component hybrid mortar
- Rapid curing
- Suitable for overhead fastenings
- Versatile and conventional handling
- Clean and simple in use
- Small edge distance and anchor spacing
- Always correct mixing ratio

Base material



Concrete
(non-cracked)

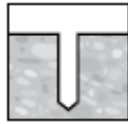

Dry concrete

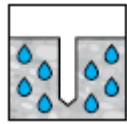

Wet concrete

Load conditions

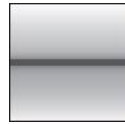

Static/
quasi-static

Installation conditions

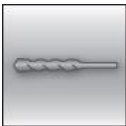

Hammer
drilling

Other information

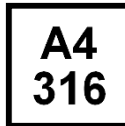

Corrosion
resistance

Approvals / certificates

Description	Authority / Laboratory	No. / date of issue
Hilti Technical Data ^{a)}	Hilti	2017-11-28

a) All data given in this section according to Hilti Technical Data.

Basic loading data (for a single anchor)

Data in this section applies to:

- Correct setting (See setting instruction)
- No edge distance and spacing influence
- Steel failure
- Base material thickness, as specified in the table
- One typical embedment depth, as specified in the table
- One anchor material, as specified in the tables
- Non-cracked concrete C 20/25, $f_{ck,cube} = 25 \text{ N/mm}^2$
- Temperate range I
(min. base material temperature -40°C , max. long term/short term base material temperature: $+24^\circ\text{C}/40^\circ\text{C}$)

Embedment depth and base material thickness for HIT-V and HAS-(E) rods

Threaded rods			M8	M10	M12	M16
Embedment depth	h_{ef}	[mm]	80	90	110	125
Base material thickness	h	[mm]	110	120	140	161

Recommended loads ^{a)} for HIT-V and HAS-(E) rods

Threaded rods			M8	M10	M12	M16
Tension	N_{Rec}	[kN]	5,0	7,0	10,0	12,0

a) The data provided in the table is intended for product comparison only and not suitable for the complete design of an anchorage.

Materials

Material quality for HIT-V

Part	Material
Zinc coated steel	
Threaded rod, HIT-V 5.8 (F) HAS-(E)	Strength class 5.8; Elongation at fracture A5 > 8% ductile Electroplated zinc coated $\geq 5\mu\text{m}$; (F) hot dip galvanized $\geq 45 \mu\text{m}$
Threaded rod, HIT-V 8.8 (F) HAS-(E)R	Strength class 8.8; Elongation at fracture A5 > 12% ductile Electroplated zinc coated $\geq 5\mu\text{m}$; (F) hot dip galvanized $\geq 45 \mu\text{m}$
Washer	Electroplated zinc coated $\geq 5 \mu\text{m}$, hot dip galvanized $\geq 45 \mu\text{m}$
Nut	Strength class of nut adapted to strength class of threaded rod. Electroplated zinc coated $\geq 5\mu\text{m}$, hot dip galvanized $\geq 45 \mu\text{m}$
Stainless Steel	
Threaded rod, HIT-V-R	Strength class 70 for $\leq \text{M24}$ and strength class 50 for $> \text{M24}$; Elongation at fracture A5 > 8% ductile Stainless steel 1.4401; 1.4404; 1.4578; 1.4571; 1.4439; 1.4362
Washer	Stainless steel 1.4401, 1.4404, 1.4578, 1.4571, 1.4439, 1.4362 EN 10088-1:2014
Nut	Stainless steel 1.4401, 1.4404, 1.4578, 1.4571, 1.4439, 1.4362 EN 10088-1:2014

Material quality for HIS-N

Part	Material	
HIS-N	Internal threaded sleeve	C-steel 1.0718; Steel galvanized $\geq 5 \mu\text{m}$
	Screw 8.8	Strength class 8.8, A5 > 8 % Ductile; Steel galvanized $\geq 5 \mu\text{m}$
HIS-RN	Internal threaded sleeve	Stainless steel 1.4401, 1.4571
	Screw 70	Strength class 70, A5 > 8 % Ductile Stainless steel 1.4401; 1.4404, 1.4578; 1.4571; 1.4439; 1.4362

Setting information

Installation temperature range:
0°C to +40°C

In service temperature range

Hilti HIT-HY MM+ injection mortar with anchor rods may be applied in the temperature ranges given below. An elevated base material temperature leads to a reduction of the design bond resistance.

Temperature range	Base material temperature	Max. long term base material temperature	Max. short term base material temperature
Temperature range	-40 °C to + 40 °C	+ 24 °C	+ 40 °C

Max. short term base material temperature

Short term elevated base material temperatures are those that occur over brief intervals, e.g. as a result of diurnal cycling.

Max. long term base material temperature

Long term elevated base material temperatures are roughly constant over significant periods of time.

Working time and curing time

Temperature of the base material T	Working time t_{gel}	Minimum curing time $t_{cure}^{1)}$
0 °C	10 min	4 h
0 °C < TBM < 5 °C	10 min	2.5 h
5 °C < TBM ≤ 10 °C	8 min	1.5 h
10 °C < TBM ≤ 20 °C	5 min	45 min
20 °C < TBM ≤ 30 °C	3 min	30 min
30 °C < TBM ≤ 40 °C	2 min	20 min

1) The curing time data are valid for dry base material only. In wet base material, the curing times must be doubled.

Setting details for HIT-V / HAS

Threaded rods	M8	M10	M12	M16
Nominal diameter of drill bit d_0 [mm]	10	12	14	18
Effect. anchorage depth h_{ef} [mm]	80	90	110	125
Min. base material thickness: h_{min} [mm]	110	120	140	161
Diameter of clearance hole in the fixture d_f [mm]	9	12	14	18
Minimum spacing s_{min} [mm]	40	50	60	80
Minimum edge distance c_{min} [mm]	40	50	60	80
Torque moment T_{max} [Nm]	10	20	40	80

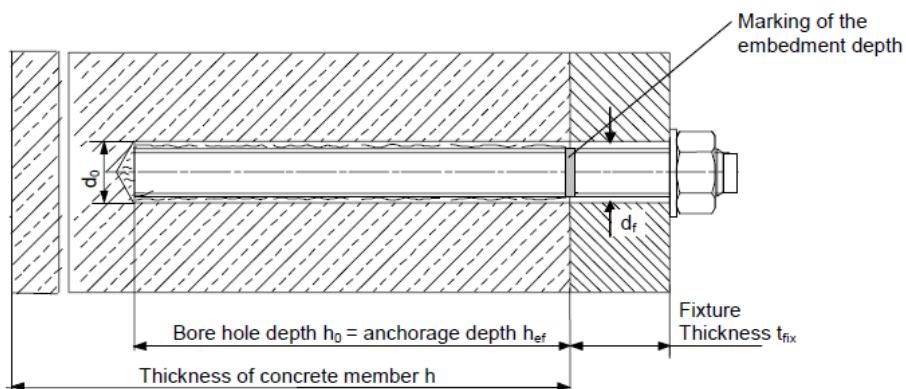

Setting details for HIS-N

Anchor size			M8	M10	M12	M16
Nominal diameter of drill bit	d_0	[mm]	14	18	22	28
Diameter of element	d	[mm]	12,5	16,5	20,5	25,4
Effective anchorage depth	h_{ef}	[mm]	12,5	16,5	20,5	170
Minimum base material thickness	h_{min}	[mm]	120	146	169	226
Diameter of clearance hole in the fixture	d_f	[mm]	9	12	14	18
Thread engagement length; min – max	h_s	[mm]	8-20	10-25	12-30	16-40
Torque moment	T_{max}	[Nm]	10	20	40	80
Minimum spacing	s_{min}	[mm]	60	75	90	115
Minimum edge distance	c_{min}	[mm]	40	45	55	65

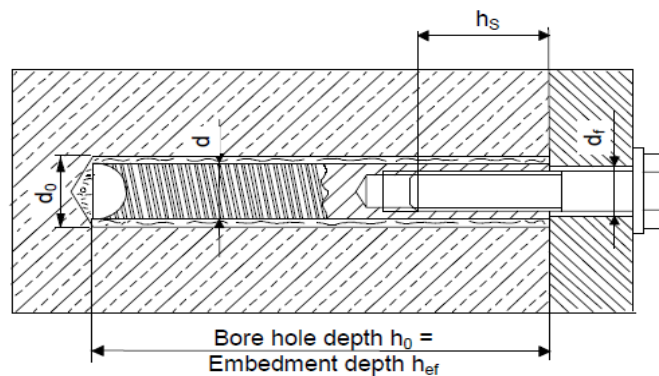

Installation equipment

Anchor size	M8	M10	M12	M16
Rotary hammer	TE2 – TE16			
Other tools	blow out pump, set of cleaning brushes, dispenser			

Drilling and cleaning parameters

HIT-V HAS	HIS-N	Hammer drill	Brush HIT-RB	Piston plug HIT-SZ
		d_0 [mm]	size [mm]	
M8	-	10	10	-
M10	-	12	12	12
M12	M8	14	14	14
M16	M10	18	18	18
-	M12	22	22	22
-	M16	28	28	28

Setting instructions

*For detailed information on installation see instruction for use given with the package of the product.



Safety regulations.

Review the Material Safety Data Sheet (MSDS) before use for proper and safe handling! Wear well-fitting protective goggles and protective gloves when working with Hilti HIT-MM Plus.

Drilling

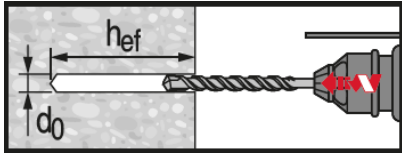

Hammer drilled hole (HD)

Cleaning

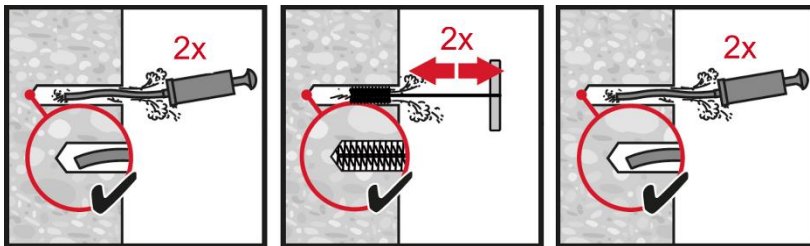

Manual cleaning (MC)
Non-cracked concrete only

for drill diameters $d_0 \leq 18$ mm and drill hole depth $h_0 \leq 10 \cdot d_0$.

Injection system

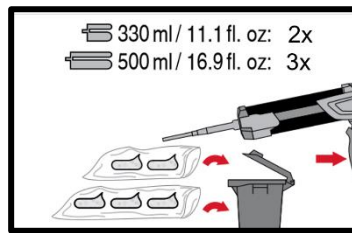
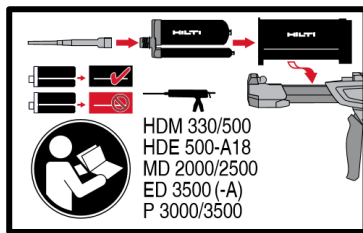

Injection system preparation.

Injection system

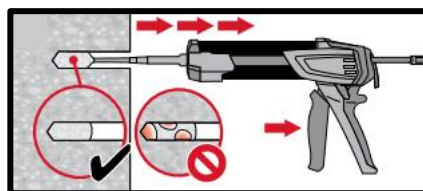
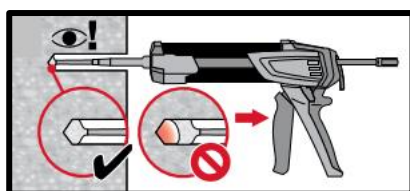

Injection method for drill hole depth

$h_{ef} \leq 250$ mm.

Setting the element

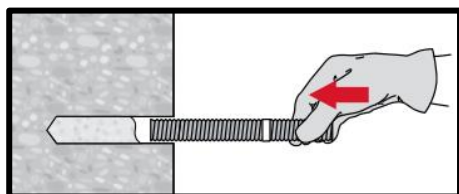

Setting element, observe working time " t_{work} ",

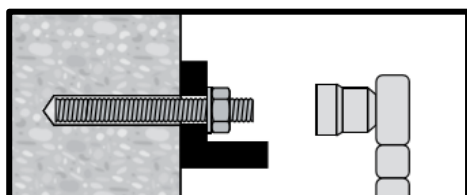

Loading the anchor after required curing time t_{cure} the anchor can be loaded. The applied installation torque shall not exceed T_{max} .

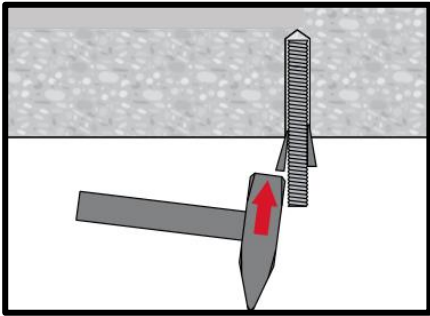

Setting element for overhead applications, observe working time “ t_{work} ”

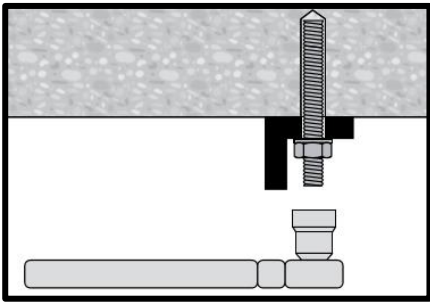

Loading the anchor after required curing time t_{cure} the anchor can be loaded. The applied installation torque shall not exceed T_{max} .

HIT-MM Plus injection mortar

Anchor design (ETAG 029) / Rods&Sleeves / Masonry

Injection mortar system



Hilti HIT-MM Plus

300 ml foil pack
(also available as 500 ml foil pack)



Anchor rods:
HIT-V
HIT-V-R rods
(M8-M12)



Anchor rods:
HAS
HAS-E rods
(M8-M16)



Anchor rods:
HIT-IC
(M6-M12)



Internally threaded sleeves:
HIS-N
HIS-RN sleeves
(M8-M12)

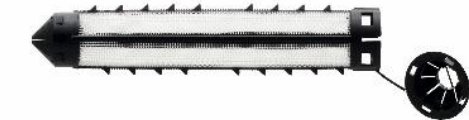

Sieve sleeves:
HIT-SC
(16-22)

Benefits

- Chemical injection fastening for all type of base materials:
- Hollos and solid clay bricks, sand-lime bricks, normal and light weight concrete blocks, aereated light weight concrete, natural stones
- Two component hybrid mortar
- Rapid curing
- Flexible setting depth and fastening thickness
- Suitable for overhead fastenings
- Versatile and conventional handling
- Clean and simple in use
- Small edge distance and anchor spacing
- Always correct mixing ratio

Base material

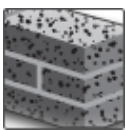

Solid brick

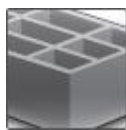

Hollow brick

Load conditions



Static/
quasi-static

Installation conditions

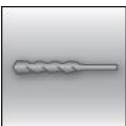

Hammer /
rotary drilling

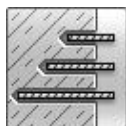

Variable
embedment
depth

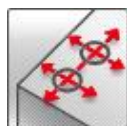

Small edge
distance and
spacing

Other information

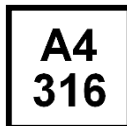

Corrosion
resistance

Approvals / certificates

Description	Authority / Laboratory	No. / date of issue
Hilti Technical Data ^{a)}	Hilti	2017-11-28



b) All data given in this section according to Hilti Technical Data.

Static and quasi-static loading (for a single anchor)

All data in this section applies to:

- Load values valid for holes drilled with TE rotary hammers in hammering (solid bricks) / rotary (hollow bricks) mode.
- Correct anchor setting (see instruction for use, setting details)
- Steel quality of fastening elements: see data below
- Steel quality for screws for HIT-IC and HIS-N: min. grade 5.8 / HIS-RN: A4-70
- Threaded rods of appropriate size (diameter and length) and a minimum steel quality of 5.6 can be used

Recommended loads $F_{rec}^{b)}$ for pull-out failure in [kN]

Anchor size		HAS / HAS-E / HIT-V				HIT-IC		
		M8	M10	M12	M8	M10	M12	
Solid Masonry								
Solid clay brick Mz12/2,0 DIN 105/ EN 771-1 $f_{b a)} \geq 12 \text{ N/mm}^2$ 	Setting depth [mm]	80	80	80	80	80	80	80
	F_{rec} [kN]	0,9	1,5	1,5	0,9	1,5	1,5	
Hollow Masonry								
Hiz 12 DIN 105/ EN 771-1 $f_{b a)} \geq 12 \text{ N/mm}^2$ 	Sieve Sleeve HIT-	16x...	16x...	18x...	22x...	16x...	16x...	16x...
	Setting depth [mm]	80	80	80	80	80	80	80
	F_{rec} [kN]	0,8	0,8	0,8	0,8	0,8	0,8	0,8

a) f_b = brick strength

b) The data provided in the table is intended for product comparison only and not suitable for the complete design of an anchorage

Due to the wide variety of bricks site tests have to be performed for determination of load values for all applications outside of the above mentioned base materials and / or setting conditions.

Materials

Material quality

Part	Material
Threaded rod HIT-V, HAS-(E)	Strength class 5.8, EN ISO 898-1, A5 > 8% ductile Steel galvanized $\geq 5 \mu\text{m}$, EN ISO 4042
Threaded rod HIT-V-R / HAS-(E)R	Stainless steel grade A4, strength class 70; A5 > 8% Ductile Stainless steel 1.4401; 1.4404; 1.4578; 1.4571; 1.4439; 1.4362 EN 10088
HIT-IC sleeve	Carbon steel; galvanized to min. 5 μm
HIS-N	C-steel 1.0718, EN 10277-3, Steel galvanized $\geq 5 \mu\text{m}$ EN ISO 4042
HIS-RN	Stainless steel 1.4401 and 1.4571 EN 10088
Washer ISO 7089	Steel galvanized EN ISO 4042
	Stainless steel, EN 10088: 1.4401; 1.4404; 1.4578; 1.4571; 1.4439; 1.4362
Nut EN ISO 4032	Strength class 8 ISO 898-2 Steel galvanized $\geq 5 \mu\text{m}$ EN ISO 4042
	Strength class 70 EN ISO 3506-2, stainless steel grade A4, EN 10088: Stainless steel 1.4401; 1.4404; 1.4578; 1.4571; 1.4439; 1.4362
HIT-SC sleeve	PA/PP

Setting information

Installation temperature range:

Solid masonry: 5°C to +40°C

Hollow masonry: -5°C to +40°C

In service temperature range

Hilti HIT-HY MM+ injection mortar with anchor rods may be applied in the temperature ranges given below. An elevated base material temperature leads to a reduction of the design bond resistance.

Temperature range	Base material temperature	Max. long term base material temperature	Max. short term base material temperature
Temperature range I	-40 °C to + 40 °C	+ 24 °C	+ 40 °C
Temperature range II	-40 °C to + 80 °C	+ 50 °C	+ 80 °C

Max. short term base material temperature

Short term elevated base material temperatures are those that occur over brief intervals, e.g. as a result of diurnal cycling.

Max. long term base material temperature

Long term elevated base material temperatures are roughly constant over significant periods of time.

Working time and curing time

Temperature of the base material	Maximum working time t_{work}	Minimum curing time t_{cure}
0 °C < T_{BM} ≤ 5 °C ^{a)}	10 min ^{a)}	6 h ^{a)}
5 °C < T_{BM} ≤ 10 °C	8 min	3 h
10 °C < T_{BM} ≤ 20 °C	5 min	2 h
20 °C < T_{BM} ≤ 30 °C	3 min	60 min
30 °C < T_{BM} ≤ 40 °C	2 min	45 min

a) For hollow bricks only.

Setting details for solid bricks

Anchor size	HIT-V			HAS / HAS-E / HAS-R			
	M8	M10	M12	M8	M10	M12	M16
Sieve sleeve HIT-SC	-	-	-	-	-	-	-
Nominal diameter of drill bit d_0 [mm]	10	12	14	10	12	14	18
Effective anchorage and drill hole depth h_{ef} [mm]	80	80	80	80	90	110	125
Hole depth h_0 [mm]	85	85	85	85	95	115	130
Minimum base material thickness h_{min} [mm]	115	115	115	110	120	140	170
Diameter of clearance hole in the fixture d_f [mm]	9	12	14	9	12	14	18
Min. spacing s_{min} [mm]	100	100	100	100	100	100	100
Min. edge distance c_{min} [mm]	100	100	100	100	100	100	100
Torque moment T_{max} [Nm]	5	8	10	5	8	10	10
Filing volume [ml]	4	5	7	4	6	10	15

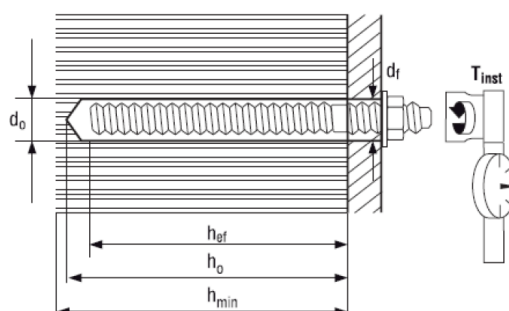

Setting details for solid bricks

Anchor size	HIT-IC			HIS-(R)N			
	M8	M10	M12	M8	M10	M12	
Sieve sleeve	HIT-SC						-
Nominal diameter of drill bit	d_0 [mm]	14	16	18	14	18	22
Effective anchorage and drill hole depth	h_{ef} [mm]	80	80	80	90	110	125
Hole depth	h_0 [mm]	85	85	85	95	115	130
Minimum base material thickness	h_{min} [mm]	115	115	115	120	150	170
Diameter of clearance hole in the fixture	d_f [mm]	9	12	14	9	12	14
Length of bolt engagement	h_s [mm]	min. 10 – max. 75			min. 8 max. 20	min. 10 max. 25	min. 12 max. 30
Min. spacing ^{a)}	s_{min} [mm]	100	100	100	100	100	100
Min. edge distance ^{a)}	c_{min} [mm]	100	100	100	100	100	100
Torque moment	T_{max} [Nm]	5	8	10	5	8	10
Filing volume	[ml]	6	6	6	6	10	16

HIT-IC

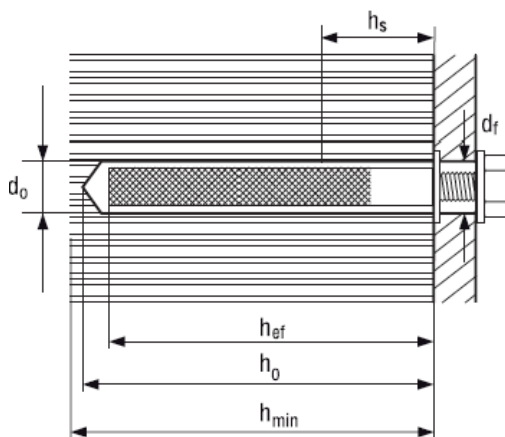

HIS-N/RN

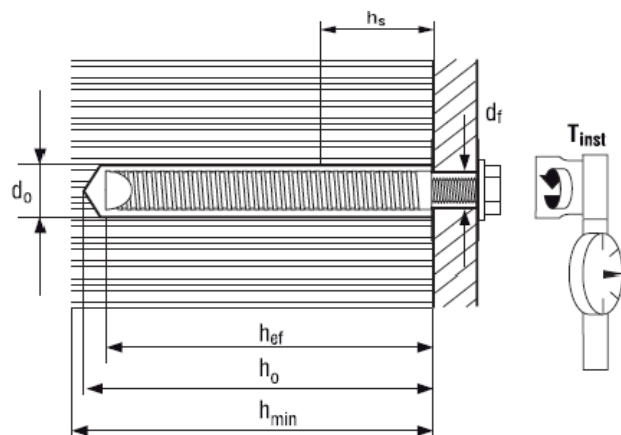

Setting details for hollow bricks

Anchor size	HAS / HIT-V										
	M6		M8		M10		M12				
Sieve sleeve	HIT-SC										
Nominal diameter of drill bit	d_0 [mm]	12	12	16	16	16	16	18	18	22	22
Effective anchorage and drill hole depth	h_{ef} [mm]	50	80	50	80	50	80	50	80	50	80
Hole depth	h_0 [mm]	60	95	60	95	60	95	60	95	60	95
Minimum base material thickness	h_{min} [mm]	80	115	80	115	80	115	80	115	80	115
Diameter of clearance hole in the fixture	d_f [mm]	7	7	9	9	12	12	14	14	14	14
Min. spacing ^{a)}	s_{min} [mm]	100	100	100	100	100	100	100	100	100	100
Min. edge distance ^{a)}	c_{min} [mm]	100	100	100	100	100	100	100	100	100	100
Torque moment	T_{max} [Nm]	3	3	3	3	4	4	6	6	6	6
Filing volume	[ml]	12	24	18	30	18	30	18	36	30	55

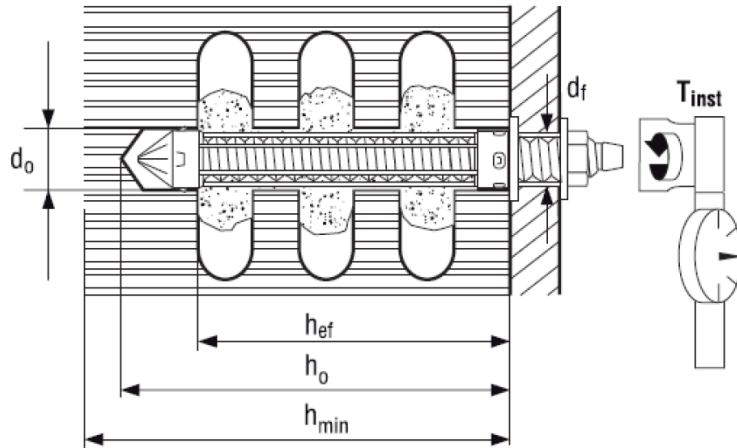
Setting details for hollow bricks

Anchor size		HIT-IC		
		M8	M10	M12
Sieve sleeve	HIT-SC	16x85	18x85	22x85
Nominal diameter of drill bit	d_o [mm]	16	18	22
Effective anchorage and drill hole depth	h_{ef} [mm]	80	80	80
Hole depth	h_o [mm]	95	95	95
Minimum base material thickness	h_{min} [mm]	115	115	115
Diameter of clearance hole in the fixture	d_{fr} [mm]	9	12	14
Length of bolt engagement	h_s [mm]	min. 10 – max. 75		
Min. spacing ^{a)}	s_{min} [mm]	100	100	100
Min. edge distance ^{a)}	c_{min} [mm]	100	100	100
Torque moment	T_{max} [Nm]	3	4	6
Filing volume	[ml]	30	36	45

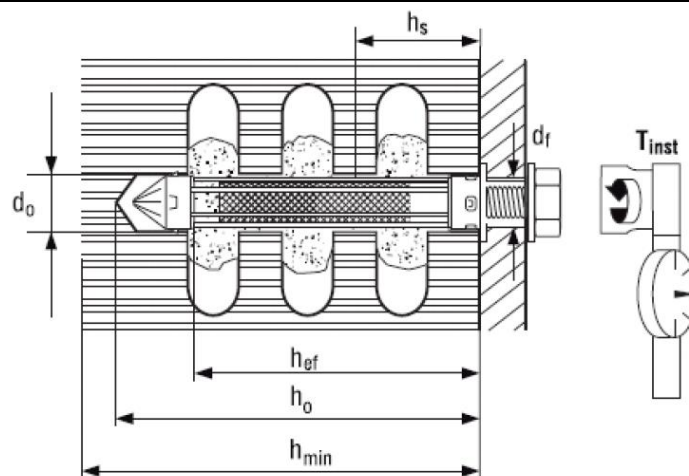

Drilling and cleaning parameters for solid bricks

HIT-V HAS	HIT-IC	HIS-N	Hammer drill	Brush HIT-RB	Piston plug HIT-SZ
			d_0 [mm]	size [mm]	
M8	-	-	10	10	-
M10	-	-	12	12	12
M12	M8	M8	14	14	14
-	M10	-	16	16	16
M16 ^{a)}	M12	M10	18	18	18
-	-	M12	22	22	22

a) Only for HAS (-E) threaded rods.

Drilling and cleaning parameters for hollow bricks

HIT-V (-R) HAS (-E) + sieve sleeve	HIT-IC + sieve sleeve	Hammer drill	Brush HIT-RB	Piston plug HIT-SZ
		d_0 [mm]	size [mm]	
M6	-	12	12	12
M8	-	16	16	16
M10	M8	16	16	16
M12	M10	18	18	18
M12 ^{a)}	M12	22	22	22

b) M12 with sieve sleeve SC22x50

Setting instructions

*For detailed information on installation see instruction for use given with the package of the product.



Safety regulations.

Review the Material Safety Data Sheet (MSDS) before use for proper and safe handling! Wear well-fitting protective goggles and protective gloves when working with Hilti HIT-HY MM+.

Drilling

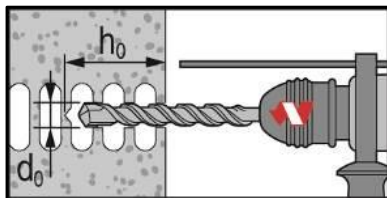

In hollow bricks: rotary mode

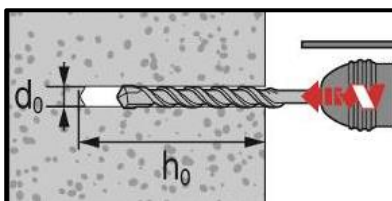

In solid bricks: hammer mode

Cleaning

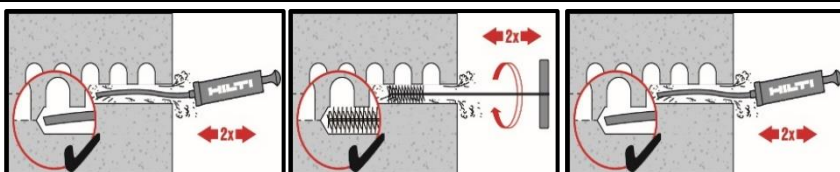

Manual cleaning (MC)

Instructions for solid bricks without sieve sleeve

Injection system

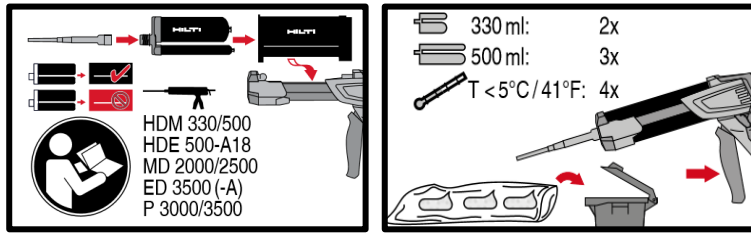

Injection system preparation.

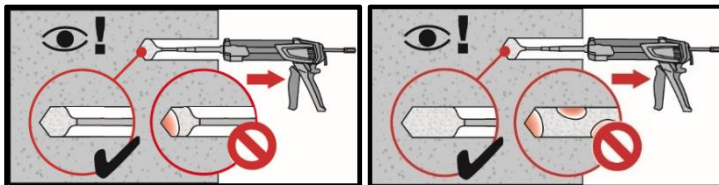

Injection method for drill hole

Setting the element

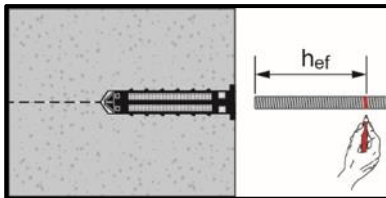

Presetting element, observe working time "t_{work}",

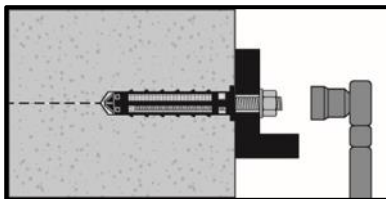

Loading the anchor: After required curing time t_{cure} the anchor can be loaded.

Instructions for hollow and solid bricks with sieve sleeve

Preparation of the sieve sleeve

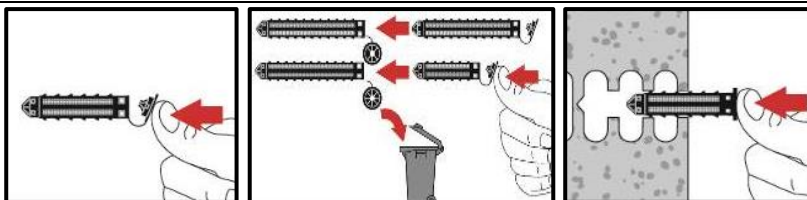

Close lid and insert sieve sleeve manually

Injection system

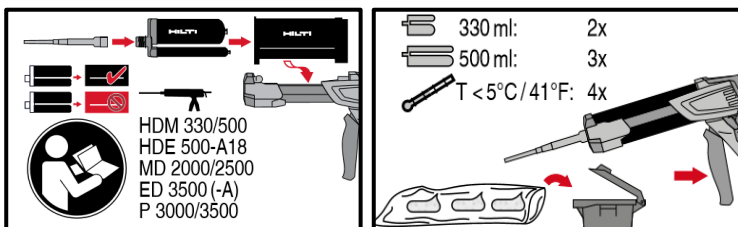

Injection system preparation.

Injection system: hollow bricks

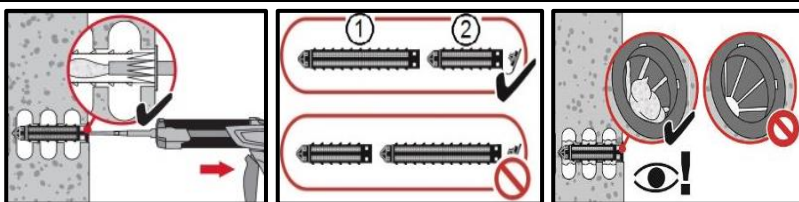

Installation with sieve sleeve HIT-SC

Setting the element

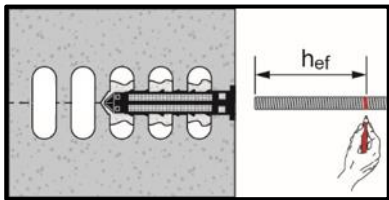

Presetting element, observe working time " t_{work} ",

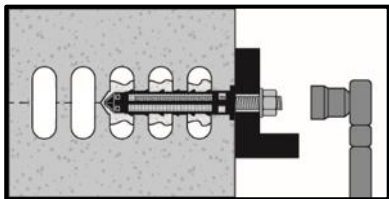

Loading the anchor: After required curing time t_{cure} the anchor can be loaded.



HIT-1 / HIT-1 CE injection mortar

Anchor design (ETAG 001) / Rods&Sleeves / Concrete

Injection mortar system



Hilti HIT-1 / HIT-1 CE
300 ml tube cartridge



Anchor rods:
HIT-V(F)
HIT-V-R
HIT-V-HCR
(M8-M16)

Benefits

- Chemical injection fastening
- Two-component hybrid mortar
- Rapid curing
- Suitable for overhead fastenings
- Versatile and convenient handling
- Clean and simple in use
- Small edge distance and anchor spacing
- Always correct mixing ratio
- In-service temperatures:

Base material



Concrete
(non-cracked)



Dry concrete

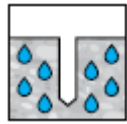

Wet concrete

Load conditions

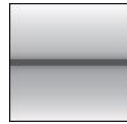

Static/
quasi-static

Installation conditions



Hammer
drilling

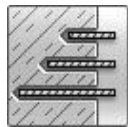

Variable
embedment
depth

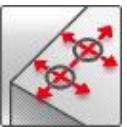

Small edge
distance and
spacing

Other information



European
Technical
Assessment



CE
conformity

Approvals / certificates

Description	Authority / Laboratory	No. / date of issue
European Technical Assessment ^{a)}	TTIC, Prague	ETA-17/0005 / 2017-02-20

a) All data given in this section according to ETA-17/0005, issue 2017-02-20.

Multimaterial
Chemical anchors
Mechanical anchors
Plastic/Light duty metal anchors
Insulation anchors

Static and quasi-static loading (for a single anchor)

All data in this section applies to

- Non-cracked concrete C 20/25, $f_{ck,cube} = 25 \text{ N/mm}^2$
- Load values valid for holes drilled with TE rotary hammers in hammering mode
- Diamond coring is not permitted
- Correct anchor setting (see instruction for use, setting details)
- No edge distance and spacing influence
- Embedment depth, base material thickness, as specified in the tables
- Base material temperature during installation and curing must be between 0°C through +40°C
- Temperature range I and II, as specified in the tables
- *Steel* failure

Recommended loads for tension loading

Threaded rod HIT-V 5.8		M8	M10	M12	M16
Temperature range I (24/40°C)					
Embedment depth	$h_{ef,min}$ [mm]	60	60	70	80
Base material thickness	h [mm]	100	100	100	116
Tensile load	N_{rec} [kN]	4,2	5,2	7,3	9,6
Temperature range I (24/40°C) - continued					
Embedment depth	$h_{ef,10d}$ [mm]	80	100	120	160
Base material thickness	h [mm]	110	130	150	196
Tensile load	N_{rec} [kN]	5,6	8,7	12,6	19,2
Temperature range I (24/40°C) - continued					
Embedment depth	$h_{ef,20d}$ [mm]	160	200	240	320
Base material thickness	h [mm]	190	210	270	356
Tensile load	N_{rec} [kN]	8,7	13,8	20,1	37,4
Temperature range II (50/80°C)					
Embedment depth	$h_{ef,min}$ [mm]	60	60	70	80
Base material thickness	h [mm]	100	100	100	116
Tensile load	N_{rec} [kN]	3,0	3,7	5,2	7,2
Temperature range II (50/80°C) - continued					
Embedment depth	$h_{ef,10d}$ [mm]	80	100	120	160
Base material thickness	h [mm]	110	130	150	196
Tensile load	N_{rec} [kN]	4,0	6,2	9,0	14,4
Temperature range II (50/80°C) - continued					
Embedment depth	$h_{ef,20d}$ [mm]	160	200	240	320
Base material thickness	h [mm]	190	210	270	356
Tensile load	N_{rec} [kN]	8,0	12,5	18,0	28,7

Recommended loads for shear loading

Threaded rod HIT-V 5.8		M8	M10	M12	M16
Shear load	V_{rec} [kN]	5,1	8,6	12,0	22,3

Materials

Mechanical properties

Anchor size		M8	M10	M12	M16
Nominal tensile strength f_{uk}	HIT-V 5.8	500	500	500	500
	HIT-V 8.8	800	800	800	800
	HIT-V-R	700	700	700	700
	HIT-V-HCR	800	800	800	800
Yield strength f_{yk}	HIT-V 5.8	400	400	400	400
	HIT-V 8.8	640	640	640	640
	HIT-V-R	450	450	450	450
	HIT-V-HCR	640	640	640	640
Stressed cross-section A_s	HIT-V	36,6	58,0	84,3	157
Moment of resistance W	HIT-V	31,2	62,3	109	277

Material quality for HIT-V

Part	Material
Zinc coated steel	
Threaded rod, HIT-V 5.8 (F)	Strength class 5.8; Elongation at fracture $A_5 > 8\%$ ductile Electroplated zinc coated $\geq 5\mu\text{m}$; (F) hot dip galvanized $\geq 45\mu\text{m}$
Threaded rod, HIT-V 8.8 (F)	Strength class 8.8; Elongation at fracture $A_5 > 12\%$ ductile Electroplated zinc coated $\geq 5\mu\text{m}$; (F) hot dip galvanized $\geq 45\mu\text{m}$
Washer	Electroplated zinc coated $\geq 5\mu\text{m}$, hot dip galvanized $\geq 45\mu\text{m}$
Nut	Strength class of nut adapted to strength class of threaded rod. Electroplated zinc coated $\geq 5\mu\text{m}$, hot dip galvanized $\geq 45\mu\text{m}$
Stainless Steel	
Threaded rod, HIT-V-R	Strength class 70 for $\leq M24$ and strength class 50 for $> M24$; Elongation at fracture $A_5 > 8\%$ ductile Stainless steel 1.4401; 1.4404; 1.4578; 1.4571; 1.4439; 1.4362
Washer	Stainless steel 1.4401, 1.4404, 1.4578, 1.4571, 1.4439, 1.4362 EN 10088-1:2014
Nut	Stainless steel 1.4401, 1.4404, 1.4578, 1.4571, 1.4439, 1.4362 EN 10088-1:2014
High corrosion resistant steel	
Threaded rod, HIT-V-HCR	Strength class 80 for $\leq M20$ and class 70 for $> M20$, Elongation at fracture $A_5 > 8\%$ ductile High corrosion resistance steel 1.4529; 1.4565;
Washer	High corrosion resistant steel 1.4529, 1.4565 EN 10088-1:2014
Nut	High corrosion resistant steel 1.4529, 1.4565 EN 10088-1:2014

Setting information

Installation temperature range:

+5°C to +40°C

Service temperature range

Hilti HIT-1 / HIT-1 CE injection mortar may be applied in the temperature ranges given below. An elevated base material temperature may lead to a reduction of the design bond resistance.

Temperature range	Base material temperature	Maximum long term base material temperature	Maximum short term base material temperature
Temperature range I	-40 °C to +40 °C	+24 °C	+40 °C
Temperature range II	-40 °C to +80 °C	+50 °C	+80 °C

Max short term base material temperature

Short-term elevated base material temperatures are those that occur over brief intervals, e.g. as a result of diurnal cycling.

Max long term base material temperature

Long-term elevated base material temperatures are roughly constant over significant periods of time.

Working time and curing time:

Temperature of the base material T_{BM}	Maximum working time t_{work}	Minimum curing time t_{cure}
$-5^{\circ}\text{C} \leq T_{BM} < 0^{\circ}\text{C}$	1,5 h	6 h
$0^{\circ}\text{C} \leq T_{BM} < 5^{\circ}\text{C}$	45 min	3 h
$5^{\circ}\text{C} \leq T_{BM} < 10^{\circ}\text{C}$	25 min	2 h
$10^{\circ}\text{C} \leq T_{BM} < 15^{\circ}\text{C}$	20 min	100 min
$15^{\circ}\text{C} \leq T_{BM} < 20^{\circ}\text{C}$	15 min	80 min
$20^{\circ}\text{C} \leq T_{BM} < 30^{\circ}\text{C}$	6 min	45 min
$30^{\circ}\text{C} \leq T_{BM} < 34^{\circ}\text{C}$	4 min	25 min
$35^{\circ}\text{C} \leq T_{BM} < 40^{\circ}\text{C}$	2 min	20 min

Setting details





Threaded rod – size		M8	M10	M12	M16
Nominal diameter of drill bit	d_0 [mm]	10	12	14	18
Nominal diameter of element	d [mm]	8	10	12	16
Maximum diameter of clearance hole in the fixture	d_f [mm]	9	12	14	18
Diameter of steel brush	d_0 [mm]	10	12	14	16
Minimum base material thickness	h_{min} [mm]	$h_{ef} + 30 \text{ mm} \geq 100 \text{ mm}$			$h_{ef} + 2d_0$
Effective anchorage depth (= drill hole depth) $h_{ef} = h_0$	$h_{ef,min}$ [mm]	60	60	70	80
	$h_{ef,max}$ [mm]	160	200	240	320
Minimum spacing	s_{min} [mm]	40	50	60	80
Minimum edge distance	c_{min} [mm]	40	50	60	80

Installation equipment

Anchor – size	M8	M10	M12	M16
Rotary hammer	TE2(-A) – TE30(-A)			
Other tools	Blow out pump ($h_{ef} \leq 10 \cdot d$) Compressed air gun ^{b)} Set of cleaning brushes ^{c)} , dispenser, piston plug			

- a) Compressed air gun with extension hose for all drill holes deeper than 250 mm (for M8 to M12) or deeper than $20 \cdot \phi$ (for $\phi > 12$ mm)
 b) Automatic brushing with round brush for all drill holes deeper than 250 mm (for M8 to M12) or deeper than $20 \cdot \phi$ (for $\phi > 12$ mm)

Parameters of cleaning and setting tools

HIT-V	Drill and clean [mm]		Installation
	Hammer drilling	Brush HIT-RB	Piston plug HIT-SZ
			
M8	10	10	10
M10	12	12	12
M12	14	14	14
M16	18	18	18

Setting instructions

*For detailed information on installation see instruction for use given with the package of the product.



Safety regulations.

Review the Material Safety Data Sheet (MSDS) before use for proper and safe handling! Wear well-fitting protective goggles and protective gloves when working with Hilti HIT-1 / HIT-1 CE.

Drilling

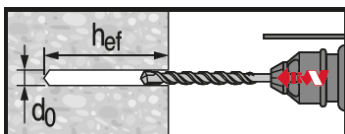

Hammer drilled hole (HD)
For dry and wet concrete only

Cleaning

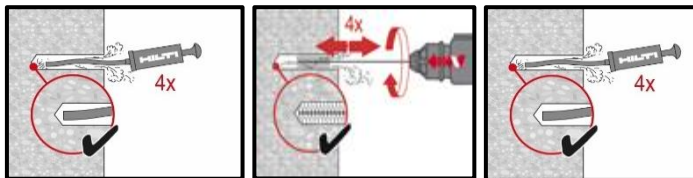

Manual cleaning with machine brushing (MCMC)

For drill diameters $d_0 \leq 20$ mm and drill hole depth $h_0 \leq 10 \cdot d$.

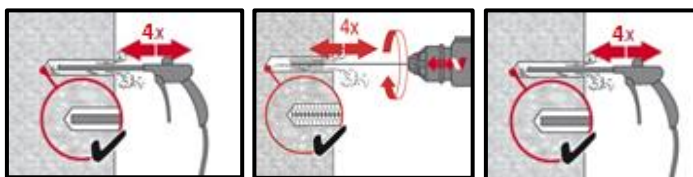

Compressed air cleaning with machine brushing (CACMB)

For drill diameters d_0 and all drill hole depth h_0 .

Injection system

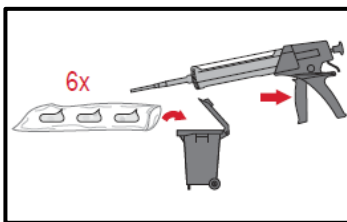
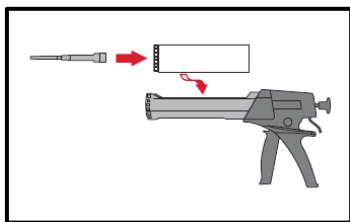

Injection system preparation

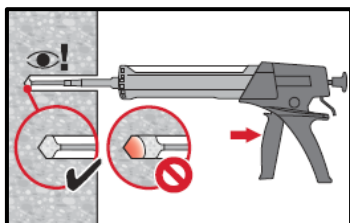

Injection method for drill hole depth
(approx. 2/3 full)

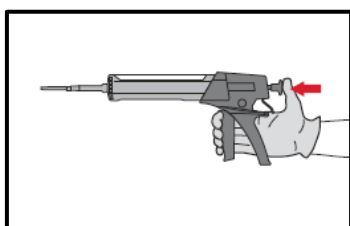

Depressurization of the dispenser.

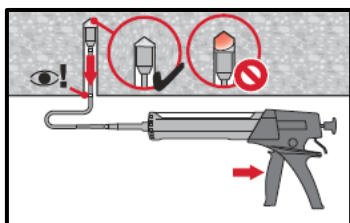

Injection method for overhead application and/or installation with embedment depth $h_{ef} > 250$ mm.

Setting the element

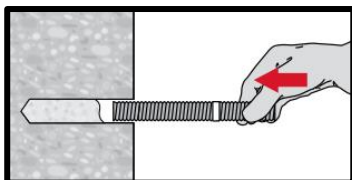

Setting the element, observe working time " t_{work} ",

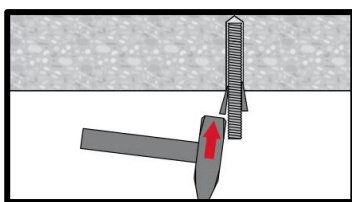

Setting element for overhead applications, observe working time " t_{work} ",

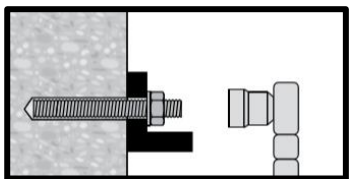

Loading the anchor: After required curing time t_{cure} the anchor can be loaded.



HIT-1 / HIT-1 CE injection mortar

Anchor design (ETAG 029) / Rods&Sleeves / Masonry

Chemical anchors Multimerial

Mechanical anchors

Plastic/Light duty metal anchors

Insulation anchors

Injection mortar system



Hilti HIT-1 / HIT-1 CE
300 ml tube cartridge



Anchor rod:
HIT-V
HIT-V-F
HIT-V-R
HIT-V-HCR rods
(M8-M12)

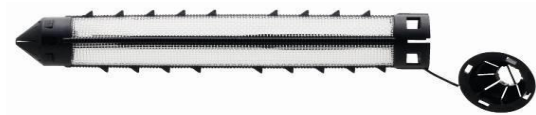

Sieve sleeve:
HIT-SC
(16)

Benefits

- Hollow and solid masonry: clay bricks
- Two-component hybrid mortar
- Rapid curing
- Suitable for overhead fastenings
- Versatile and convenient handling
- Flexible setting depth and fastening thickness
- Small edge distance and anchor spacing
- Mortar filling control with HIT-SC sleeves

Base material

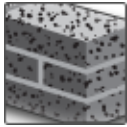

Solid bricks

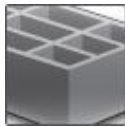

Hollow bricks

Load conditions

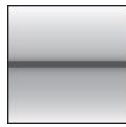

Static/
quasi-static

Installation conditions



Hammer/rotary
drilling

Approvals / certificates

Description	Authority / Laboratory	No. / date of issue
Hilti Technical Data ^{a)}	Hilti	2017-11-28

b) All data given in this section according to Hilti Technical Data.

Static and quasi-static loading (for a single anchor)

All data in this section applies to

- Load values valid for holes drilled with TE rotary hammers in hammer mode for solid bricks
- Load values valid for holes drilled with TE rotary hammers in rotary mode for hollow bricks
- Correct anchor setting (see instruction for use, setting details)
- Steel quality of fastening elements: see data below
- Threaded rods of appropriate size (diameter and length) and a minimum steel quality of 5.6 can be used
- Base material temperature during installation and curing must be between 0°C through +40°C

Recommended loads for solid bricks

Anchor size			M8		M10		M12		
Sieve sleeve	HIT-SC		-	16x85	-	16x85	-	16x85	
Compressive strength	f_b	[N/mm ²]	28	28	28	28	28	28	
Effective anchorage depth	h_{ef}	[mm]	80	80	90	80	100	80	
Tensile load	40°C/24°C	N_{rec}	[kN]	0,7	0,9	0,7	0,9	0,7	0,9
	80°C/50°C			0,4	0,6	0,4	0,6	0,4	0,6
Shear load	V_{rec}	[kN]	1,3	1,3	1,7	1,6	2,5	1,7	

Recommended loads for hollow bricks

Anchor size			M8		M10		M12		
Hollow bricks type			HZL 12	Doppio Uni	HZL 12	Doppio Uni	HZL 12	Doppio Uni	
Sieve sleeve	HIT-SC		16x85		16x85		16x85		
Compressive strength	f_b	[N/mm ²]	12	28	12	28	12	28	
Effective anchorage depth	h_{ef}	[mm]	80	80	80	80	80	80	
Tensile load	40°C/24°C	N_{rec}	[kN]	0,35	0,25	0,35	0,25	0,45	0,35
	80°C/50°C			0,20	0,15	0,20	0,20	0,25	0,20
Shear load	V_{rec}	[kN]	1,40	0,85	1,40	0,85	1,40	0,85	

Due to the wide variety of bricks, site tests have to be performed for determination of load values for all applications outside of the above mentioned base materials and/or setting conditions.

Materials

Material quality

Part	Material
Threaded rod HIT-V 5,8 (F)	Strength class 5,8, A5 > 8% ductile Electroplated zinc coated $\geq 5\mu\text{m}$ (F) Hot dip galvanized $\geq 45\mu\text{m}$
Threaded rod HIT-V 8,8 (F)	Strength class 8,8, A5 > 12% ductile Electroplated zinc coated $\geq 5\mu\text{m}$ (F) Hot dip galvanized $\geq 45\mu\text{m}$
Threaded rod HIT-V-R	Strength class 70 for $\leq M24$ and class 50 for $> M24$, A5 > 8% ductile Stainless steel 1,4401; 1,4404; 1,4578; 1,4571; 1,4439; 1,4362
Threaded rod HIT-V-HCR	Strength class 70 for $\leq M24$ and class 50 for $> M24$, A5 > 8% ductile High corrosion resistance steel 1,4528; 1,4565;
Washer	Electroplated zinc coated $\geq 5\mu\text{m}$, hot dip galvanized $\geq 45\mu\text{m}$
	Stainless steel 1,4401, 1,4404, 1,4578, 1,4571, 1,4439, 1,4362 EN 10088-1:2014
	High corrosion resistant steel 1,4529, 1,4565 EN 10088-1:2014
Nut	Strength class of nut adapted to strength class of threaded rod, Electroplated zinc coated $\geq 5\mu\text{m}$, hot dip galvanized $\geq 45\mu\text{m}$
	Strength class of nut adapted to strength class of threaded rod, Stainless steel 1,4401, 1,4404, 1,4578, 1,4571, 1,4439, 1,4362 EN 10088-1:2014
	Strength class of nut adapted to strength class of threaded rod, High corrosion resistant steel 1,4529, 1,4565 EN 10088-1:2014
HIT-SC sleeve	Frame: FPP 20T, Sieve: PA6,6 N500/200

Setting information

Installation temperature range:
0°C to +40°C

Service temperature range

Hilti HIT-1 / HIT-1 CE injection mortar may be applied in the temperature ranges given below, An elevated base material temperature may lead to a reduction of the design bond resistance,

Temperature range	Base material temperature	Maximum long term base material temperature	Maximum short term base material temperature
Temperature range I	-40 °C to +40 °C	+24 °C	+40 °C
Temperature range II	-40 °C to +80 °C	+50 °C	+80 °C

Working time and curing time:

Temperature of the base material	Maximum working time t_{work}	Minimum curing time t_{cure}
$0^{\circ}\text{C} \leq T_{BM} < 5^{\circ}\text{C}$	45 min	3 h
$5^{\circ}\text{C} \leq T_{BM} < 10^{\circ}\text{C}$	25 min	2 h
$10^{\circ}\text{C} \leq T_{BM} < 20^{\circ}\text{C}$	15 min	100 min
$20^{\circ}\text{C} \leq T_{BM} < 30^{\circ}\text{C}$	6 min	45 min
$30^{\circ}\text{C} \leq T_{BM} < 40^{\circ}\text{C}$	2 min	25 min

Setting details for solid bricks

Anchor size	HIT-SC		M8		M10		M12	
	Sieve sleeve	HIT-SC	-	16x85	-	16x85	-	16x85
Nominal diameter of drill bit	d_0	[mm]	10	16	12	16	14	18
Max, diameter of clearance hole in the fixture	d_f	[mm]	9	9	12	12	14	14
Effective anchorage depth	h_{ef}	[mm]	80	80	90	80	100	80
Hole depth	h_0	[mm]	80	95	90	95	100	95
Minimum base material thickness	h_{min}	[mm]	115	115	115	115	115	115
Torque moment	T_{max}	[Nm]	6	6	10	8	10	8

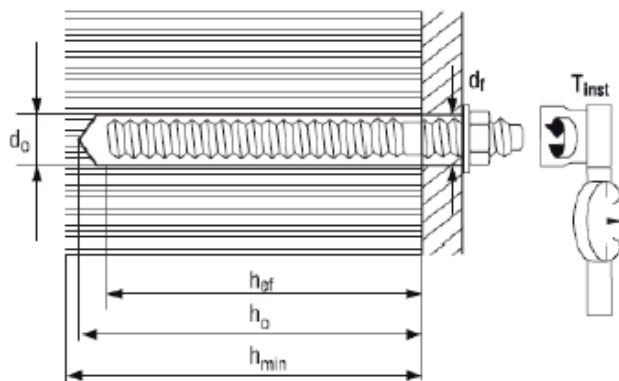

Setting details for hollow bricks

Anchor Size	M8		M10		M12	
	HLZ2	Doppio Uni	HLZ2	Doppio Uni	HLZ2	Doppio Uni
Sieve sleeve	HIT-SC		16x85		16x85	
Nominal diameter of drill bit	d_o	[mm]	16	16	18	
Max, diameter of clearance hole in the fixture	d_f	[mm]	9	12	14	
Effective anchorage depth	h_{ef}	[mm]	80	80	80	
Hole depth	h_o	[mm]	95	95	95	
Minimum base material thickness	h_{min}	[mm]	115	115	115	
Torque moment	T_{max}	[Nm]	4	4	4	

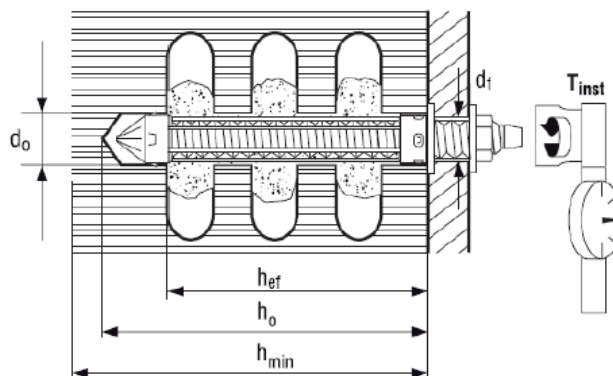

Installation equipment

Anchor – size	M8	M10	M12
Rotary hammer	TE2(-A) – TE30(-A)		
Other tools	Blow out pump Set of cleaning brushes, dispenser		

Cleaning and setting parameters for solid and hollow bricks

HIT-V	Sieve sleeve HIT-SC	Drill and clean [mm]	
		Hammer drilling	Brush HIT-RB
M8 ^{a)}	-	10	10
M10 ^{a)}	-	12	12
M12 ^{a)}	-	14	14
M8	HIT-SC 16x85	16	16
M10	HIT-SC 16x85	16	16
M12	HIT-SC 18x85	18	18

a) Installation without the sieve sleeve HIT-SC can be used only in case of solid bricks.

Setting instructions

*For detailed information on installation see instruction for use given with the package of the product.



Safety regulations.

Review the Material Safety Data Sheet (MSDS) before use for proper and safe handling! Wear well-fitting protective goggles and protective gloves when working with Hilti HIT-1 / HIT-1 CE.

Drilling

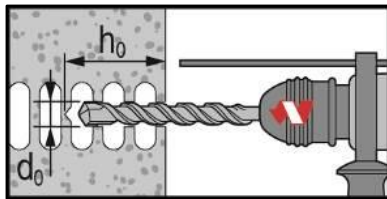

In hollow bricks: rotary mode

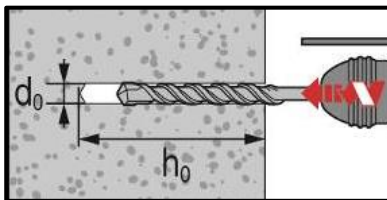

In solid bricks: hammer mode

Cleaning

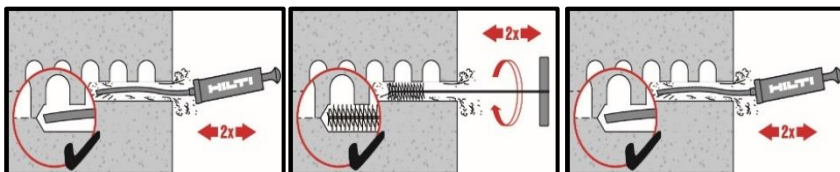

Manual cleaning (MC)

Instructions for solid bricks without sieve sleeve

Injection system

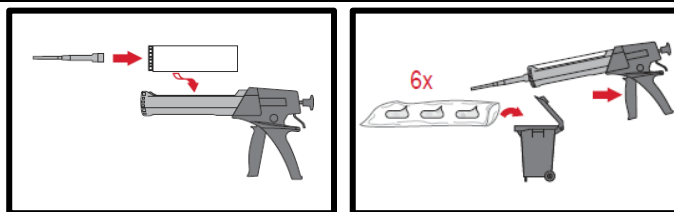

Injection system preparation.

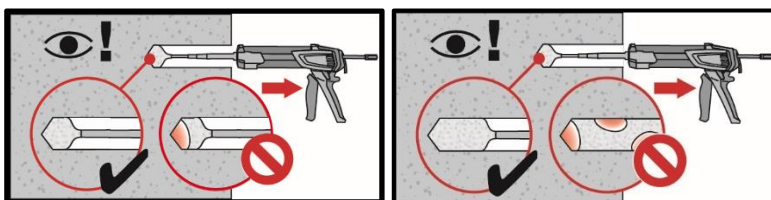

Injection method for drill hole

Setting the element

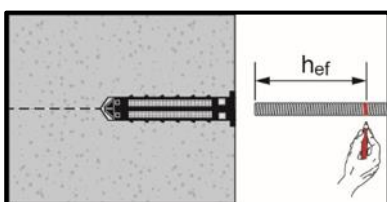

Presetting element, observe working time " t_{work} ",

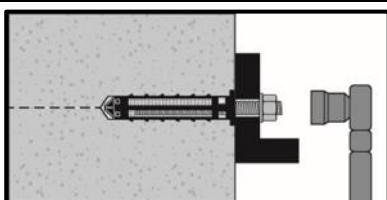

Loading the anchor: After required curing time t_{cure} the anchor can be loaded.

Instructions for hollow and solid bricks with sieve sleeve

Preparation of the sieve sleeve

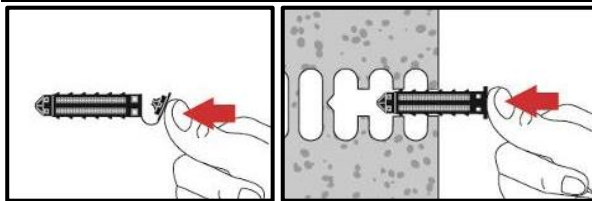

Close lid and insert sieve sleeve manually

Injection system

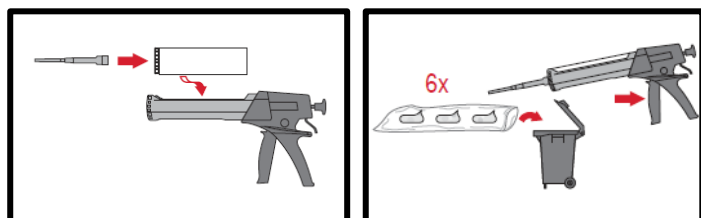

Injection system preparation.

Injection system: hollow bricks

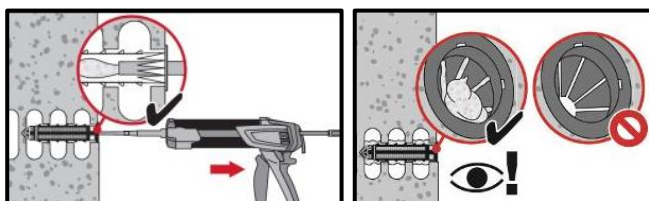

Installation with sieve sleeve HIT-SC

Setting the element

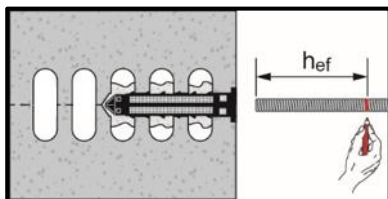

Presetting element, observe working time "t_{work}",

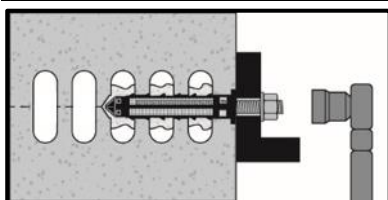

Loading the anchor: After required curing time t_{cure} the anchor can be loaded.

HIT-HY 270 injection mortar

Anchor design (ETAG 029) / Rods&Sleeves / Masonry

Masonry

Chemical anchors

Mechanical anchors

Plastic/Light duty metal anchors

Insulation anchors

Injection mortar system



Hilti HIT-HY 270
330 ml foil pack
(also available as
500 ml foil pack)



Anchor rod:
HIT-V
HIT-V-F
HIT-V-R
HIT-V-HCR rods
(M6-M16)



Internally threaded
sleeve:
HIT-IC (M8-M12)

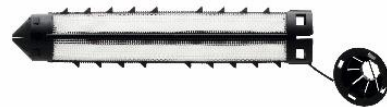

Sieve sleeves:
HIT-SC (12-22)

Benefits

- Chemical injection fastening for the most common types of base materials:
- Hollow and solid clay bricks, calcium silicate bricks, normal and light weight concrete blocks
- Two-component hybrid mortar
- Versatile and convenient handling with HDE dispenser
- Flexible setting depth and fastening thickness
- Small edge distance and anchor spacing
- Suitable for overhead fastenings

Base material

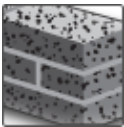

Solid brick

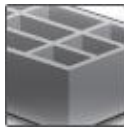

Hollow brick

Load conditions

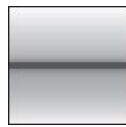

Static/
quasi-static



Fire
resistance

Installation conditions

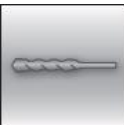

Hammer
drill bit
(Hammer
mode and
rotary mode)

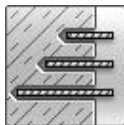

Variable
embedment
depth

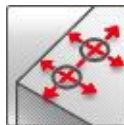

Small edge
distance and
spacing

Other informations



European
Technical
Assessment



CE
conformity

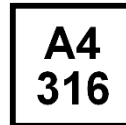

Corrosion
resistance



High
corrosion
resistance



PROFIS
Engineering
design
software

Approvals / certificates

Description	Authority / Laboratory	No. / date of issue
European technical assessment	DIBt, Berlin	ETA-13/1036 / 2017-12-12
Hilti Technical Data ^{a)}	Hilti	2017-12-12
Fire test report	MFPA, Leipzig	PB 3.2/14-179-1 / 2014-09-05

a) Hilti Technical Data is based on testing and assessment by Hilti following EAD 330076-00-0604, EOTA TR053 and TR054

Brick types and properties

Instruction to this technical data

- Identify/choose your brick (or brick type) and its geometrical/physical properties on the following tables. Information about edge and spacing criteria is available on page 5.
 - The pages referred on the last column of the table below contain the design resistance loads for pull-out failure of the anchor, brick breakout failure and local brick failure for each respective brick. Notice that the data displayed on these tables is only valid for single anchors with distance to edge such that loading capacity is not influenced by it – for other cases not covered, use PROFIS Engineering software, consult ETA-13/1036 or contact Hilti Engineering Team.
- The resistance loads provided by this technical data manual are valid only for exact same masonry unit (hollow bricks) or for units made of the same base material with equal or higher size and compressive strength (solid bricks). For other cases, on-site tests must be performed-please consult page 18.

Exterior brick dimensions

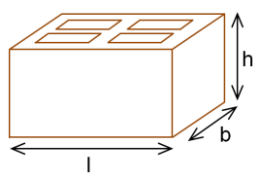

Generic bricks

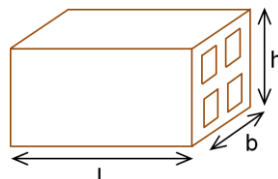

Bricks HC5, CC1 and CC2

Interior dimensions of the majority of the holes

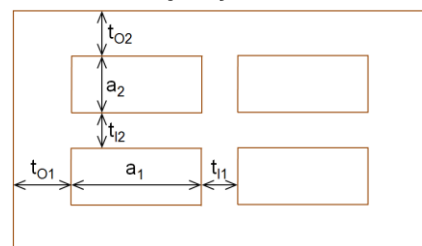

Brick types and properties

Brick code	Data	Brick name	Image	Size [mm]	t_0 [mm]	t_1 [mm]	a [mm]	f_b [N/mm ²]	ρ [kg/dm ³]	Page
Solid clay										
SC1	ETA	Solid clay brick Mz, 1DF		l: ≥ 240 b: ≥ 115 h: ≥ 52	-	-	-	12 20 40	2,0	8
SC2	ETA	Solid clay brick Mz, NF		l: ≥ 240 b: ≥ 115 h: ≥ 72	-	-	-	10 20	2,0	9
SC3	ETA	Solid clay brick Mz, 2DF		l: ≥ 240 b: ≥ 115 h: ≥ 113	-	-	-	12 20	2,0	9
SC4	Hilti Data	UK London yellow Multi Stock		l: 215 b: 100 h: 65	-	-	-	16	1,5	10
SC5	Hilti Data	Australian common dry pressed		l: 230 b: 110 h: 76	-	-	-	25	2,0	10
Hollow clay										
HC1	ETA	Hollow clay brick Hz, 10DF		l: 300 b: 240 h: 238	t_{01} : 12 t_{02} : 15	t_{11} : 11 t_{12} : 15	a_1 : 10 a_2 : 25	12 20	1,4	10
HC2	Hilti Data	Italy Mattone Alveolater 50		l: 300 b: 245 h: 185	t_{01} : 12 t_{02} : 12	t_{11} : 9 t_{12} : 9	a_1 : 22 a_2 : 25	16	1,0	10
HC3	Hilti Data	Spain Termoarcilla		l: 300 b: 192 h: 190	t_{01} : 9 t_{02} : 9	t_{11} : 7 t_{12} : 7	a_1 : 17 a_2 : --	22	0,9	10
HC4	Hilti Data	Belgium Wienerberger Thermobrick		l: 285 b: 135 h: 138	t_{01} : 10 t_{02} : 10	t_{11} : 7 t_{12} : 7	a_1 : 14 a_2 : 34	21	0,9	10
HC5	Hilti Data	Spain Hueco doble		l: 232 b: 115 h: 78	t_{01} : 9 t_{02} : 9	t_{11} : 8 t_{12} : 8	a_1 : 28 a_2 : 28	4	0,8	11

Brick code	Data	Brick name	Image	Size [mm]	t ₀ [mm]	t ₁ [mm]	a [mm]	f _b [N/mm ²]	ρ [kg/dm ³]	Page
HC6	Hilti Data	Belgium Wienerberger Powerbrick		l: 285 b: 135 h: 135	t ₀₁ : 16 t ₀₂ : 12	t ₁₁ : 10 t ₁₂ : 10	a ₁ : 12 a ₂ : 31	41	1,2	11
HC7	Hilti Data	Italy Doppio uni		l: 240 b: 120 h: 120	t ₀₁ : 12 t ₀₂ : 12	t ₁₁ : 10 t ₁₂ : 12	a ₁ : 22 a ₂ : 24	27	1,1	11
HC8	Hilti Data	Spain Ladrillo cara vista		l: 240 b: 115 h: 49	t ₀₁ : 13 t ₀₂ : 16	t ₁₁ : 7 t ₁₂ : 7	a ₁ : 30 a ₂ : 33	42	1,2	11
HC9	Hilti Data	Spain Clinker mediterraneo		l: 240 b: 115 h: 49	t ₀₁ : 17 t ₀₂ : 17	t ₁₁ : 7 t ₁₂ : 7	a ₁ : 29 a ₂ : 29	78	1,3	11
HC10	Hilti Data	UK Nostell red multi		l: 215 b: 102 h: 65	t ₀₁ : 23 t ₀₂ : 21	t ₁₁ : 28 t ₁₂ : --	a ₁ : 38 a ₂ : 56	70	1,6	11
HC11	Hilti Data	Australian common standard		l: 330 b: 110 h: 76	t ₀₁ : 20 t ₀₂ : 16	t ₁₁ : 16 t ₁₂ : 20	a ₁ : 25 a ₂ : 36	84	1,5	12
Clay Ceiling										
CC1	ETA	Clay ceiling brick Ds-1,0		l: 250 b: 510 h: 180	t ₀₁ : 12 t ₀₂ : 12	t ₁₁ : 7 t ₁₂ : 7	a ₁ : 14 a ₂ : 32	3	1,0	12
CC2	Hilti Data	Italy Mattone rosso		l: 250 b: 400 h: 180	t ₀₁ : 9 t ₀₂ : 9	t ₁₁ : 7 t ₁₂ : 7	a ₁ : 69 a ₂ : 55	26	0,6	12
Solid Calcium Silicate										
SCS1	ETA	Solid silica brick KS, 2DF		l: ≥ 240 b: ≥ 115 h: ≥ 113	-	-	-	12 28	2,0	12
SCS2	ETA	Solid silica brick KS, 8DF		l: ≥ 248 b: ≥ 240 h: ≥ 248	-	-	-	12 20 28	2,0	13
Hollow Calcium Silicate										
HCS1	ETA	Hollow silica brick KSL, 8DF		l: 248 b: 240 h: 238	t ₀₁ : 34 t ₀₂ : 22	t ₁₁ : 11 t ₁₂ : 20	a ₁ : 52 a ₂ : 52	12 20	1,4	13
HCS2	Hilti Data	Germany KSL 12		l: 240 b: 175 h: 113	t ₀₁ : 18 t ₀₂ : 20	t ₁₁ : -- t ₁₂ : --	a ₁ : -- a ₂ : --	12	1,6	13
Solid Light weight concrete										
SLWC 1	ETA	Solid lightweight concrete brick Vbl, 2DF		l: ≥ 240 b: ≥ 115 h: ≥ 113	-	-	-	4 6	0,9	14
SLWC 2	Hilti Data	Sweden Leca typ 3		l: 550 b: 190 h: 190	-	-	-	3	0,6	14
SLWC 3	Hilti Data	Italy "Tufo" volcanic rock		l: 380 b: 270 h: 270	-	-	-	4	1,2	14
Hollow Light weight concrete										
HLW C1	ETA	Hollow lightweight concrete brick Hbl, 16DF		l: 495 b: 240 h: 238	t ₀₁ : 25 t ₀₂ : 51	t ₁₁ : 35 t ₁₂ : 36	a ₁ : 196 a ₂ : 52	2 6	0,7	14

Brick code	Data	Brick name	Image	Size [mm]	t ₀ [mm]	t ₁ [mm]	a [mm]	f _b [N/mm ²]	ρ [kg/dm ³]	Page
HLWC 2	Hilti Data	Germany Hbl 2		l: 248 b: 300 h: 248	t ₀₁ : 17 t ₀₂ : 21	t ₁₁ : 24 t ₁₂ : 22	a ₁ : 87 a ₂ : 40	2	0,6	14
HLWC 3	Hilti Data	Germany Hbl 4		l: 248 b: 240 h: 248	t ₀₁ : 48 t ₀₂ : 41	t ₁₁ : -- t ₁₂ : 62	a ₁ : 140 a ₂ : 49	4	0,7	15
Solid Normal weight concrete										
SNW C1	ETA	Solid normal weight concrete brick Vbn, 2DF		l: ≥ 240 b: ≥ 115 h: ≥ 113	-	-	-	6 16	2,0	15
SNW C2	Hilti Data	UK Dense Concrete b=100mm		l: 440 b: 100 h: 215	-	-	-	14	2,0	15
SNW C3	Hilti Data	UK Dense concrete b=140mm		l: 440 b: 140 h: 215	-	-	-	14	2,0	15
Hollow Normal weight concrete										
HNW C1	ETA	Hollow normal weight concrete brick parpaing		l: 500 b: 200 h: 200	t ₀₁ : 15 t ₀₂ : 15	t ₁₁ : 15 t ₁₂ : 15	a ₁ : 133 a ₂ : 75	4 10	0,9	15
HNW C2	Hilti Data	Italy Blocchi Cem		l: 500 b: 200 h: 200	t ₀₁ : 30 t ₀₂ : 30	t ₁₁ : 30 t ₁₂ : --	a ₁ : 200 a ₂ : 135	8	1,0	16
HNW C3	Hilti Data	Germany Hbn 4		l: 365 b: 240 h: 238	t ₀₁ : 26 t ₀₂ : 35	t ₁₁ : 26 t ₁₂ : 26	a ₁ : 128 a ₂ : 62	4 10	1,4	16
HNW C4	Hilti Data	UK (b=215 mm)		l: 440 b: 215 h: 215	t ₀₁ : 48 t ₀₂ : 48	t ₁₁ : 40 t ₁₂ : --	a ₁ : 150 a ₂ : 120	10	1,2	16
HNW C5	Hilti Data	UK (b=138 mm)		l: 440 b: 138 h: 215	t ₀₁ : 48 t ₀₂ : 38	t ₁₁ : 48 t ₁₂ : --	a ₁ : 150 a ₂ : 60	13	1,5	16
HNW C6	Hilti Data	UK (b=112 mm)		l: 440 b: 112 h: 215	t ₀₁ : 30 t ₀₂ : 30	t ₁₁ : 30 t ₁₂ : --	a ₁ : 50 a ₂ : 50	7	1,3	16
HNW C7	Hilti Data	Finland Standard concrete brick		l: 600 b: 500 h: 92	t ₀₁ : 32 t ₀₂ : 15	t ₁₁ : 32 t ₁₂ : --	a ₁ : 62 a ₂ : 62	6	0,9	16
HNW C8	Hilti Data	Australian block system 200		l: 390 b: 190 h: 190	t ₀₁ : 30 t ₀₂ : 30	t ₁₁ : 30 t ₁₂ : --	a ₁ : 150 a ₂ : 130	15	1,1	16

Anchor installation parameters

Brick position:

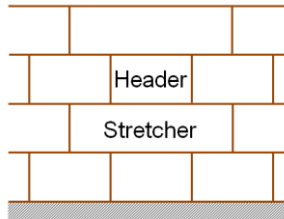

- **Header (H):** The longest dimension of the brick represents the width of the wall
- **Stretcher (S):** The longest dimension of the brick represents the length of the wall

Spacing and edge distance:

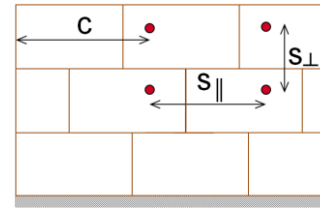

- c - Distance to the edge
- s_{||} - Spacing parallel to the bed joint
- s_⊥ - Spacing perpendicular to the bed joint

Allowed anchor positions:

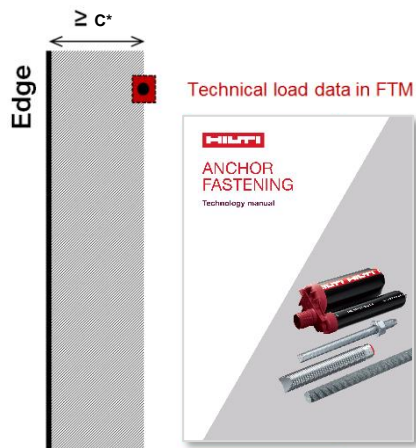

- This FTM includes the load data for single anchors in masonry with a distance to edge equal to or greater than c^* .
- c^* is the distance from the anchor to the edge of the wall, such that the loading capacity of the anchor is not influenced by the edge.
- Minimum spacing between anchors = MAX ($3 \times h_{ef}$; size of brick in respective direction). This applies for a (conservative) manual design/calculation of a baseplate using the load tables in this manual.
- For an optimized design or cases not covered in this technical data, including anchor groups, please use PROFIS Engineering software or consult ETA-13/1036.

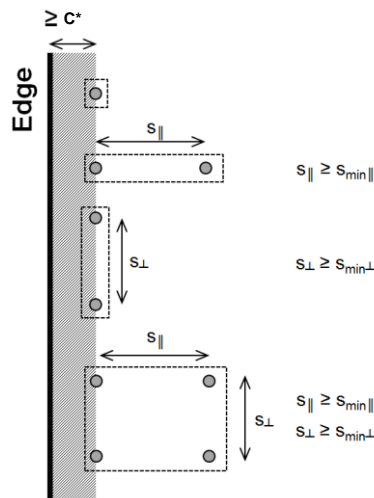

PROFIS Engineering software interface:

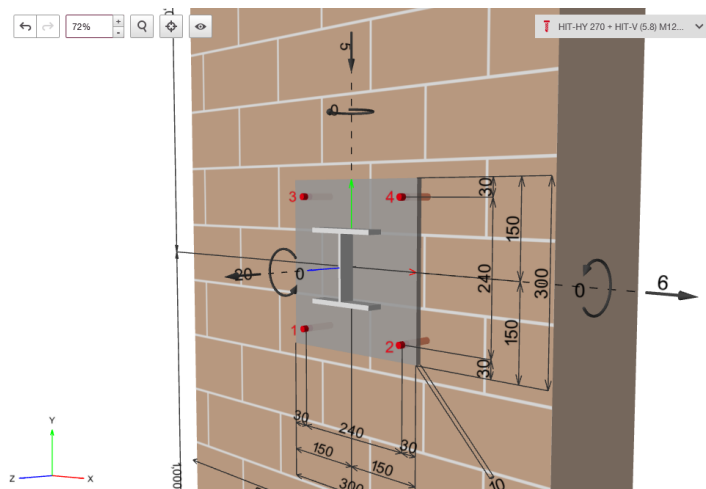

Anchor dimensions for HIT-V

Anchor size		M6	M8	M10	M12	M16
Embedment depth	with HIT-SC	Variable length from 50 to 160				
	without HIT-SC	Variable length from 50 to 300				

Anchor dimensions for HIT-IC

Anchor size	M8x80	M10x80	M12x80
Embedment depth h_{ef} [mm]	80	80	80

Design

- Anchorages are designed under the responsibility of an engineer experienced in anchorages and masonry work.
- Verifiable calculation notes and drawings are prepared taking account of the loads to be anchored. The position of the anchor is indicated on the design drawings (e.g. position of the anchor relative to supports, etc.).
- Anchorages under static or quasi-static loading are designed in accordance with: ETAG 029, Annex C, Design method A

Basic loading data (for a single anchor)

The load tables provide the design resistance values for a single loaded anchor.

All data in this section applies to

- Edge distance $c \geq c^*$. For other applications, use Hilti PROFIS Engineering software.
- Correct anchor setting (see instruction for use, setting details)

Anchorages subject to:		Hilti HIT-HY 270 with HIT-V or HIT-IC	
		in solid bricks	in hollow bricks
Hole drilling		hammer mode	rotary mode
Use category: dry or wet structure		Category d/d - Installation and use in structures subject to dry , internal conditions, Category w/d - Installation in dry or wet substrate and use in structures subject to dry , internal conditions (except calcium silicate bricks), Category w/w - Installation and use in structures subject to dry or wet environmental conditions (except calcium silicate bricks).	
Installation direction	Masonry	horizontal	
Installation direction	Ceiling brick	overhead	
Temperature in the base material at installation		+5° C to +40° C	-5° C to +40° C
In-service temperature	Temperature range Ta:	-40 °C to +40 °C	(max. long term temperature +24 °C and max. short term temperature +40 °C)
	Temperature range Tb:	-40 °C to +80 °C	(max. long term temperature +50 °C and max. short term temperature +80 °C)

Design – Failure modes

The design tensile resistance is the lower value of:

Failure due to tension loads		Condition
Failure of the metal part		$N_{Sd}^h \leq N_{Rd,s} = N_{Rk,s} / \gamma_{Ms}$
Pull-out failure of the anchor		$N_{Sd}^h \leq N_{Rd,p} = N_{Rk,p} / \gamma_{Mm}$
Brick breakout failure		$N_{Sd} \leq N_{Rd,b} = N_{Rk,b} / \gamma_{Mm}$ $N_{Sd}^g \leq N_{Rd}^g = N_{Rk}^g / \gamma_{Mm}$
Pull out of one brick		$N_{Sd} \leq N_{Rd,pb} = N_{Rk,pb} / \gamma_{Mm}$

The design shear resistance is the lower value of:

Failure due to shear loads		Condition
Failure of the metal part		$V_{Sd}^h \leq V_{Rd,s} = V_{Rk,s} / \gamma_{Ms}$
Local brick failure		$V_{Sd} \leq V_{Rd,b} = V_{Rk,b} / \gamma_{Mm}$ $V_{Sd}^g \leq V_{Rd}^g = V_{Rk}^g / \gamma_{Mm}$
Brick edge failure		$V_{Sd} \leq V_{Rd,c} = V_{Rk,c} / \gamma_{Mm}$ $V_{Sd}^g \leq V_{Rd}^g = V_{Rk}^g / \gamma_{Mm}$
Pushing out of one brick		$V_{Sd} \leq V_{Rd,pb} = V_{Rk,pb} / \gamma_{Mm}$

- Notice that loads are affected by a series of factors such as visibility/filling of joints, factors for anchor groups, spacing and edge distance.
- For other applications not covered in this FTM, use Hilti PROFIS Engineering software.

Partial safety factors

Base material	Failure (rupture) mode - Injection Anchor (γ_{Mm})
Masonry	2,5

Failure (rupture) mode - Metal part (γ_{Ms})		
Tension loading	Shear loading	
	if $f_{uk} \leq 800 \text{ N/mm}^2$ and $f_{yk}/f_{uk} \leq 0,8$	if $f_{uk} > 800 \text{ N/mm}^2$ or $f_{yk}/f_{uk} > 0,8$
1,2 / (f_{yk} / f_{uk}) \geq 1,4	1,0 / (f_{yk} / f_{uk}) \geq 1,25	1,5

Design tension and shear resistances – Steel failure for threaded rods HIT-V

Anchor size		M6	M8	M10	M12	M16
$N_{Rd,s}$	HIT-V 5.8(F)	6,7	12,0	19,3	28,0	52,7
	HIT-V 8.8(F)	10,7	19,3	30,7	44,7	84,0
	HIT-V-R	7,5	13,9	21,9	31,6	58,8
	HIT-V-HCR	10,7	19,3	30,7	44,7	84,0
$V_{Rd,s}$	HIT-V 5.8(F)	4,0	7,2	12,0	16,8	31,2
	HIT-V 8.8(F)	6,4	12,0	18,4	27,2	50,4
	HIT-V-R	4,5	8,3	12,8	19,2	35,3
	HIT-V-HCR	6,4	12,0	18,4	27,2	50,4
$M_{Rd,s}$	HIT-V 5.8(F)	6,4	15,2	29,6	52,8	133,6
	HIT-V 8.8(F)	9,6	24,0	48,0	84,0	212,8
	HIT-V-R	7,1	16,7	33,4	59,1	149,7
	HIT-V-HCR	9,6	24,0	48,0	84,0	212,8

Design tension and shear resistances – Steel failure for internally threaded rods HIT-IC

Anchor size			M8	M10	M12
$N_{Rd,s}$	HIT-IC	[Nm]	3,9	4,8	9,1
$V_{Rd,s}$	HIT-V 5.8	[Nm]	7,2	12,0	16,8
	Screw 8.8		12,0	18,4	27,2
$M_{Rd,s}$	HIT-V 5.8	[Nm]	15,2	29,6	52,8
	Screw 8.8		24,0	48,0	84,0

Design tension and shear resistances – Pull-out failure of the anchor, brick breakout failure and local brick failure at edge distance ($c \geq c^*$) for single anchor applications

Load type	Anchor size	h_{ef} [mm]	f_b [N/mm ²]	w/w and w/d		d/d	
				Ta	Tb	Ta	Tb
Loads [kN]							
 SC1 – Solid clay brick Mz, 1DF (ETA data)							
$N_{Rd,p} = N_{Rd,b}$ ($c \geq 115$ mm)	HIT-V	M8, M10, M12, M16	≥ 50	12	0,6 (0,8 ^a)		
				20	0,8 (1,0 ^a)		
				40	1,4 (1,6 ^a)		
	HIT-V HIT-V + HIT-SC HIT-IC HIT-IC + HIT-SC	M8, M10, M12, M16 M8, M10, M12, M16 M8, M10, M12 M8, M10, M12	≥ 80	12	1,0 (1,2 ^a)		
				20	1,4 (1,6 ^a)		
				40	2,2 (2,6 ^a)		
			≥ 100	12	1,4 (1,6 ^a)		
				20	1,8 (2,0 ^a)		
				40	2,8 (3,2 ^a)		
$V_{Rd,b}$ ($c \geq 115$ mm)	HIT-V	M8, M10	≥ 50	12	1,0		
				20	1,2		
				40	1,6		
	HIT-V	M12, M16	≥ 50	12	1,4		
				20	1,8		
				40	2,2		
	HIT-V HIT-V + HIT-SC HIT-IC HIT-IC + HIT-SC	M8, M10 M8, M10 M8 M8	≥ 80	12	2,0		
				20	2,4		
				40	3,0		
	HIT-V HIT-V + HIT-SC HIT-IC HIT-IC + HIT-SC	M12, M16 M12, M16 M10, M12 M10, M12	≥ 80	12	2,6		
				20	3,4		
				40	4,2		







a) Compressed Air Cleaning only

Design tension and shear resistances – Pull-out failure of the anchor, brick breakout failure and local brick failure at edge distance ($c \geq c^*$) for single anchor applications

Load type	Anchor size	h_{ef} [mm]	f_b [N/mm ²]	w/w and w/d		d/d		
				Ta	Tb	Ta	Tb	
Loads [kN]								
SC2 – Solid clay brick Mz, NF (ETA data)								
$N_{Rd,p} = N_{Rd,b}$ ($c \geq 50$ mm)	HIT-V M8, M10, M12, M16	≥ 50	10	0,6 (0,6 ^a)				
			20	0,8 (0,8 ^a)				
	HIT-V + HIT-SC M8, M10, M12, M16	≥ 80	10	1,0 (1,2 ^a)				
			20	1,4 (1,6 ^a)				
$N_{Rd,p} = N_{Rd,b}$ ($c \geq 150$ mm)	HIT-IC M8, M10, M12	≥ 100	10	1,6 (1,8 ^a)				
			HIT-IC + HIT-SC M8, M10, M12	20	2,2 (2,4 ^a)			
$V_{Rd,b II}$ ($c \geq 50$ mm)	HIT-V M8, M10, M12, M16	≥ 50	10	1,2				
			20	1,8				
	HIT-V + HIT-SC M8, M10, M12, M16	≥ 80	10	1,6				
			HIT-IC M8, M10, M12	20	2,2			
$V_{Rd,b II}$ ($c \geq 1,5 h_{ef}$)	HIT-V M8, M10, M12, M16	≥ 50	10	1,2				
			20	1,8				
	HIT-V + HIT-SC M8, M10	≥ 80	10	2,0				
			HIT-IC M8	20	2,8			
	HIT-V + HIT-SC M8, M10	≥ 100	10	3,2				
			HIT-IC + HIT-SC M8	20	4,4			
	HIT-V M12, M16	≥ 80	10	3,6				
			HIT-IC M10, M12	20	4,8			
SC3 - Solid clay brick Mz, 2DF (ETA data)	HIT-V M8, M10, M12, M16	≥ 50	12	1,0 (1,2 ^a)				
			20	1,0 (1,2 ^a)				
		≥ 80	12	1,4 (1,6 ^a)				
			20	1,8 (2,2 ^a)				
	$N_{Rd,p} = N_{Rd,b}$ ($c \geq 115$ mm)	HIT-IC M8, M10, M12	≥ 100	12	2,4 (2,8 ^a)			
				HIT-IC + HIT-SC M8, M10, M12	20	2,8 (3,2 ^a)		
		HIT-V M8, M10, M12, M16	≥ 50	12	2,2			
				20	2,8			
$V_{Rd,b}$ ($c \geq 1,5 h_{ef}$)	HIT-V M8, M10	≥ 80	12	3,2				
			HIT-IC M8	20	4,0			
	HIT-V + HIT-SC M12	≥ 80	12	4,2				
			HIT-IC M10	20	4,8			
	HIT-V + HIT-SC M16	≥ 80	12	4,8				
			HIT-IC M12	20	4,8			







a) Compressed Air Cleaning only

Design tension and shear resistances – Pull-out failure of the anchor, brick breakout failure and local brick failure at edge distance ($c \geq c^*$) for single anchor applications

Load type	Anchor size	h_{ef} [mm]	f_b [N/mm ²]	w/w and w/d		d/d	
				Ta	Tb	Ta	Tb
Loads [kN]							
 SC4 - Solid clay brick UK London yellow Multi Stock (Hilti data)							
$N_{Rd,p} = N_{Rd,b}$ ($c \geq 100$ mm)	HIT-V + HIT-SC	M8, M10, M12, M16	≥ 50	16	1,4 (1,6 ^a)		
	HIT-V + HIT-SC	M8, M10	≥ 80		2,2 (2,6 ^a)		
	HIT-V + HIT-SC	M12, M16			2,6 (3,0 ^a)		
	HIT-IC + HIT-SC	M8, M10, M12					
$V_{Rd,b}$ ($c \geq 1,5 h_{ef}$)	HIT-V + HIT-SC	M8, M10	≥ 50	16	2,6		
	HIT-V + HIT-SC	M12, M16	≥ 80		3,2		
	HIT-V + HIT-SC	M8, M10			3,2		
	HIT-V + HIT-SC	M12, M16			4,8		
	HIT-IC + HIT-SC	M8, M10, M12					
 SC5 - Solid clay brick AUS Common dry pressed (Hilti data)							
$N_{Rd,p} = N_{Rd,b}$ ($c \geq 110$ mm)	HIT-V	M8, M10, M12	80	25	2,6 (3,0 ^a)		
	HIT-IC	M8, M10, M12					
$V_{Rd,b II}$ ($c \geq 110$ mm)	HIT-V	M8, M10	80	25	3,8		
	HIT-IC	M8					
	HIT-V	M12			4,8		
	HIT-IC	M10, M12					
 HC1 - Hollow clay brick Hz, 10DF (ETA data)							
$N_{Rd,p} = N_{Rd,b}$ ($c \geq 150$ mm)	HIT-V + HIT-SC	M8, M10, M12, M16	≥ 80	12	2,2 (2,4 ^a)		
	HIT-IC + HIT-SC	M8, M10, M12		20	2,8 (3,2 ^a)		
$V_{Rd,b II}$ ($c \geq 300$ mm)	HIT-V + HIT-SC	M8, M10	≥ 80	12	1,8		
	HIT-IC + HIT-SC	M8		20	2,2		
	HIT-V + HIT-SC	M12, M16		12	3,8		
	HIT-IC + HIT-SC	M10, M12		20	4,0		
 HC2 - Hollow clay brick Italy Mattone Alveolater 50 (Hilti data)							
$N_{Rd,p} = N_{Rd,b}$ ($c \geq 50$ mm)	HIT-V + HIT-SC	M8, M10, M12, M16	≥ 80	16	1,8 (2,0 ^a)		
	HIT-IC + HIT-SC	M8, M10, M12	≥ 130		2,6 (3,0 ^a)		
	HIT-V + HIT-SC	M8, M10, M12, M16					
$V_{Rd,b}$ ($c \geq 150$ mm)	HIT-V + HIT-SC	M8, M10, M12, M16	≥ 80	16	1,4		
	HIT-IC + HIT-SC	M8, M10, M12	≥ 130		2,6		
	HIT-V + HIT-SC	M8, M10, M12, M16					
 HC3 - Hollow clay brick Spain Termoarcilla (Hilti data)							
$N_{Rd,p} = N_{Rd,b}$ ($c_{cr} = 50$ mm)	HIT-V + HIT-SC	M8, M10, M12, M16	≥ 50	22	0,6 (0,8 ^a)		
	HIT-V + HIT-SC	M8, M10, M12, M16	≥ 80		1,0 (1,2 ^a)		
	HIT-IC + HIT-SC	M8, M10, M12					
$V_{Rd,b}$ ($c \geq 150$ mm)	HIT-V + HIT-SC	M8, M10, M12, M16	≥ 50	22	1,8		
	HIT-IC + HIT-SC	M8, M10, M12					
 HC4 - Hollow clay brick Belgium Wienerberger Thermobrick (Hilti data)							
$N_{Rd,p} = N_{Rd,b}$ ($c \geq 150$ mm)	HIT-V + HIT-SC	M8, M10, M12, M16	≥ 50	21	0,5 (0,6 ^a)		
	HIT-V + HIT-SC	M8, M10, M12, M16	≥ 80		2,2 (2,6 ^a)		
	HIT-IC + HIT-SC	M8, M10, M12					
$V_{Rd,b}$ ($c \geq 150$ mm)	HIT-V + HIT-SC	M8, M10	≥ 50	21	2,4		
	HIT-V + HIT-SC	M12, M16			2,8		
	HIT-IC + HIT-SC	M8, M10, M12					





a) Compressed Air Cleaning only

Design tension and shear resistances – Pull-out failure of the anchor, brick breakout failure and local brick failure at edge distance ($c \geq c^*$) for single anchor applications

Load type	Anchor size	h_{ef} [mm]	f_b [N/mm ²]	w/w and w/d		d/d	
				Ta	Tb	Ta	Tb
Loads [kN]							
 HC5 - Hollow clay brick Spain Hueco doble (Hilti data)							
$N_{Rd,p} = N_{Rd,b}$ ($c \geq 120$ mm)	HIT-V + HIT-SC	M8, M10, M12, M16	≥ 50	4	0,4		
	HIT-V + HIT-SC	M8	80		0,8 (1,0 ^a)		
	HIT-V + HIT-SC	M10			1,0 (1,2 ^a)		
	HIT-IC + HIT-SC	M8, M10, M12			1,4 (1,6 ^a)		
	HIT-V + HIT-SC	M12, M16					
$V_{Rd,b}$ ($c \geq 120$ mm)	HIT-V + HIT-SC	M8, M10, M12, M16	≥ 50	4	1,2		
	HIT-IC + HIT-SC	M8, M10, M12					
 HC6 - Hollow clay brick Belgium Wienerberger Powerbrick (Hilti data)							
$N_{Rd,p} = N_{Rd,b}$ ($c \geq 50$ mm)	HIT-V + HIT-SC	M8, M10, M12, M16	≥ 50	41	1,6 (1,8 ^a)		
	HIT-V + HIT-SC	M8, M10, M12, M16	≥ 80		2,6 (2,8 ^a)		
	HIT-IC + HIT-SC	M8, M10, M12					
$V_{Rd,b}$ ($c \geq 150$ mm)	HIT-V + HIT-SC	M8, M10	≥ 50	41	2,6		
	HIT-V + HIT-SC	M12, M16			4,8		
	HIT-IC + HIT-SC	M8, M10, M12					
 HC7 - Hollow clay brick Italy Doppio uni (Hilti data)							
$N_{Rd,p} = N_{Rd,b}$ ($c \geq 50$ mm)	HIT-V + HIT-SC	M8, M10, M12, M16	≥ 50	27	0,6		
	HIT-V + HIT-SC	M8, M10, M12, M16	≥ 80		1,0 (1,2 ^a)		
	HIT-IC + HIT-SC	M8, M10, M12			2,8 (3,2 ^a)		
	HIT-V + HIT-SC	M8, M10, M12, M16	≥ 130				
$V_{Rd,b}$ ($c \geq 150$ mm)	HIT-V + HIT-SC	M8, M10, M12, M16	≥ 50	27	1,6		
	HIT-V + HIT-SC	M8, M10, M12, M16	≥ 80		3,6		
	HIT-IC + HIT-SC	M8, M10, M12					
 HC8 - Hollow clay brick Spain Ladrillo cara vista (Hilti data)							
$N_{Rd,p} = N_{Rd,b}$ ($c \geq 115$ mm)	HIT-V + HIT-SC	M8, M10, M12, M16	≥ 50	42	0,6 (0,8 ^a)		
	HIT-V + HIT-SC	M8, M10, M12, M16	≥ 80		2,2 (2,6 ^a)		
	HIT-IC + HIT-SC	M8, M10, M12					
$V_{Rd,b}$ ($c \geq 115$ mm)	HIT-V + HIT-SC	M8, M10, M12, M16	≥ 50	42	1,8		
	HIT-IC + HIT-SC	M8, M10, M12					
 HC9 - Hollow clay brick Spain Clinker mediterraneo (Hilti data)							
$N_{Rd,p} = N_{Rd,b}$ ($c \geq 115$ mm)	HIT-V + HIT-SC	M8, M10, M12, M16	≥ 50	78	0,6 (0,8 ^a)		
	HIT-V + HIT-SC	M8, M10, M12, M16	≥ 80		2,0 (2,2 ^a)		
	HIT-IC + HIT-SC	M8, M10, M12					
$V_{Rd,b}$ ($c \geq 115$ mm)	HIT-V + HIT-SC	M8, M10, M12, M16	≥ 50	78	2,0		
	HIT-IC + HIT-SC	M8, M10, M12					
 HC10 Hollow clay brick UK Nostell Red Multi (Hilti data)							
$N_{Rd,p} = N_{Rd,b}$ ($c \geq 105$ mm)	HIT-V + HIT-SC	M8, M10, M12, M16	≥ 50	70	2,4 (2,8 ^a)		
	HIT-V + HIT-SC	M8, M10, M12, M16	≥ 80		2,8 (3,2 ^a)		
	HIT-IC + HIT-SC	M8, M10, M12					
$V_{Rd,b}$ ($c \geq 105$ mm)	HIT-V + HIT-SC	M8, M10, M12, M16	≥ 50	70	4,6		
	HIT-IC + HIT-SC	M8, M10, M12	≥ 80		4,8		

a) Compressed Air Cleaning only

Design tension and shear resistances – Pull-out failure of the anchor, brick breakout failure and local brick failure at edge distance ($c \geq c^*$) for single anchor applications

Load type	Anchor size	h_{ef} [mm]	f_b [N/mm ²]	w/w and w/d		d/d	
				Ta	Tb	Ta	Tb
Loads [kN]							
 HC11 Hollow clay brick AUS Common standard (Hilti data)							
$N_{Rd,p} = N_{Rd,b}$ ($c \geq 110$ mm)	HIT-V + HIT-SC	M8, M10, M12, M16	≥ 50	84	0,6 (0,8 ^a)		
	HIT-V + HIT-SC	M8, M10	≥ 80		2,6 (3,0 ^a)		
	HIT-IC + HIT-SC	M8			2,8 (3,2 ^a)		
	HIT-V + HIT-SC	M12, M16					
$V_{Rd,b II}$ ($c \geq 110$ mm)	HIT-V + HIT-SC	M8, M10	≥ 50	84	2,0		
	HIT-V + HIT-SC	M12, M16	≥ 80		2,8		
	HIT-V + HIT-SC	M16			3,8		
	HIT-IC + HIT-SC	M8, M10, M12					
 CC1 - Ceiling Hollow clay brick "Ds-1,0" (ETA data)							
$N_{Rd,p} = N_{Rd,b}$ ($c \geq 100$ mm)	HIT-V + HIT-SC	M6	≥ 80	3	0,6		
 CC2 - Ceiling Hollow clay brick Italy Mattone rosso (Hilti data)							
$N_{Rd,p} = N_{Rd,b}$ ($c \geq 100$ mm)	HIT-V + HIT-SC	M6, M8, M10, M12	≥ 80	26	0,6		
 SCS1 - Solid silica brick KS, 2DF (ETA data)							
$N_{Rd,p} = N_{Rd,b}$ ($c \geq 115$ mm)	HIT-V	M8, M10, M12, M16	≥ 50	12	-	2,4	2,0
				28	-	3,6	3,0
	HIT-V + HIT-SC	M8, M10, M12, M16	≥ 80	12	-	2,4	2,0
				28	-	3,6	3,0
				HIT-IC + HIT-SC	M8, M10, M12		
$V_{Rd,b II}$ ($c \geq 115$ mm)	HIT-V	M8, M10, M12, M16	≥ 50	12	-	2,4	
				28	-	3,6	
	HIT-V + HIT-SC	M8, M10, M12, M16	≥ 80	12	-	2,4	
				28	-	3,6	
						HIT-IC	M8, M10, M12
				HIT-IC + HIT-SC	M8, M10, M12		

a) Compressed Air Cleaning only

Design tension and shear resistances – Pull-out failure of the anchor, brick breakout failure and local brick failure at edge distance ($c \geq c^*$) for single anchor applications

Load type	Anchor size	h_{ef} [mm]	f_b [N/mm ²]	w/w and w/d		d/d		
				Ta	Tb	Ta	Tb	
Loads [kN]								
SCS2- Solid silica brick KS, 8DF (ETA data)								
N_{Rd,p} = N_{Rd,b} ($c \geq 120$ mm)	HIT-V	M8, M10, M12, M16	≥ 50	12	-	-	2,8	2,2
				20	-	-	3,6	3,0
				28	-	-	4,2	3,4
	HIT-V	M8, M10	≥ 80	12	-	-	3,4	2,8
				20	-	-	4,4	3,6
				28	-	-	4,8	4,2
	HIT-V	M12	≥ 80	12	-	-	4,6	3,8
	HIT-V + HIT-SC	M8, M10		≥ 20	-	-	4,8	
	HIT-IC	M8, M10			≥ 12	-	-	4,8
	HIT-IC + HIT-SC	M8	≥ 100	12		-	-	4,8
	HIT-V	M16		≥ 20	-	-	4,8	
	HIT-V + HIT-SC	M12, M16		≥ 12	-	-	4,8	
HIT-IC	M12	≥ 12	-		-	4,8		
HIT-IC + HIT-SC	M10, M12		≥ 100	12	-	-	4,8	4,4
HIT-V	M8, M10	≥ 20		-	-	4,8		
HIT-V + HIT-SC	M8, M10, M12, M16	≥ 12		-	-	4,8		
V_{Rd,b II} ($c \geq 120$ mm)	HIT-V	M8, M10	≥ 50	12	-	-	3,6	
				≥ 20	-	-	4,8	
	HIT-V	M12, M16	≥ 50	≥ 12	-	-	-	4,8
					-	-	-	4,8
	HIT-V + HIT-SC	M8, M10, M12, M16	≥ 80	≥ 12	-	-	4,8	
HIT-IC	M8, M10, M12	≥ 80	≥ 12	-	-	4,8		
HIT-IC + HIT-SC	M8, M10, M12	≥ 80	≥ 12	-	-	4,8		
HCS1 - Hollow silica brick KSL, 8DF (ETA data)								
N_{Rd,p} = N_{Rd,b} ($c \geq 50$ mm)	HIT-V + HIT-SC	M8, M10, M12, M16	≥ 80	12	-	-	1,6	1,2
				20	-	-	2,2	1,8
	HIT-V + HIT-SC	M8, M10, M12, M16	≥ 130	12	-	-	2,0	1,6
				20	-	-	3,0	2,4
V_{Rd,b II} ($c \geq 125$ mm)	HIT-V + HIT-SC	M8	≥ 80	12	-	-	2,4	
				20	-	-	3,6	
	HIT-V + HIT-SC	M10		12	-	-	3,6	
				20	-	-	4,8	
	HIT-IC + HIT-SC	M8		12	-	-	4,8	
				20	-	-	4,8	
HIT-V + HIT-SC	M12, M16	≥ 80	12	-	-	4,8		
			20	-	-	4,8		
HSC2 - Hollow silica brick Germany KSL, 3DF (Hilti data)								
N_{Rd,p} = N_{Rd,b} ($c \geq 50$ mm)	HIT-V + HIT-SC	M8, M10, M12, M16	≥ 80	12	-	-	2,0	1,6
V_{Rd,b} ($c \geq 120$ mm)	HIT-V + HIT-SC	M8, M10, M12, M16	≥ 80	12	-	-	2,0	

a) Compressed Air Cleaning only

Design tension and shear resistances – Pull-out failure of the anchor, brick breakout failure and local brick failure at edge distance ($c \geq c^*$) for single anchor applications

Load type	Anchor size	h_{ef} [mm]	f_b [N/mm ²]	w/w and w/d		d/d		
				Ta	Tb	Ta	Tb	
Loads [kN]								
SLWC1 - Solid lightweight concrete brick Vbl, 2DF (ETA data)								
$N_{Rd,p} = N_{Rd,b}$ ($c \geq 115$ mm)	HIT-V M8, M10, M12, M16	≥ 50	4	1,2	0,8	1,2 (1,4 ^a)	1,0	
			6	1,4	1,2	1,6	1,2 (1,4 ^a)	
	HIT-V + HIT-SC HIT-IC HIT-IC + HIT-SC	M8, M10, M12, M16 M8, M10, M12, M16 M8, M10, M12 M8, M10, M12	≥ 80	4	1,8	1,4	2,0	1,6 (1,8 ^a)
				6	2,2	1,8	2,4 (2,6 ^a)	2,0 (2,2 ^a)
				≥ 100	4	2,4	2,0	2,6 (2,8 ^a)
6	3,0	2,4	3,2 (3,4 ^a)		2,6 (2,8 ^a)			
$V_{Rd,b II}$ ($c \geq 115$ mm)	HIT-V M8, M10, M12, M16	≥ 50	4	0,8				
			6	1,0				
	HIT-V + HIT-SC HIT-IC HIT-IC + HIT-SC	M10, M12, M16 M8, M10, M12, M16 M8, M10, M12 M8, M10, M12	≥ 80	4	1,0			
				6	1,2			
SLWC2 - Solid lightweight concrete brick Sweden Leca typ 3 (Hilti data)								
$N_{Rd,p} = N_{Rd,b}$ ($c \geq 115$ mm)	HIT-V + HIT-SC	M8, M10, M12, M16	≥ 80	3	2,2	1,8	2,4 (2,6 ^a)	2,0 (2,2 ^a)
	HIT-IC + HIT-SC	M8, M10, M12						
$V_{Rd,b}$ ($c \geq 115$ mm)	HIT-V + HIT-SC	M8, M10, M12, M16	≥ 80	3	1,6			
	HIT-IC + HIT-SC	M8, M10, M12			1,0			
SLWC3 - Solid lightweight concrete brick Italy "Tufo" volcanic rock (Hilti data)								
$N_{Rd,p} = N_{Rd,b}$ ($c \geq 115$ mm)	HIT-V	M8	≥ 80	4	1,2	1,0	1,4	1,2
	HIT-V	M10			1,6	1,2	1,8	1,4 (1,6 ^a)
	HIT-V	M12			1,8	1,6	2,0	1,8
	HIT-V	M16			2,2	1,8	2,4 (2,6 ^a)	2,0 (2,2 ^a)
$V_{Rd,b}$ ($c \geq 115$ mm)	HIT-V	M8	≥ 80	4	0,8			
	HIT-V	M10, M12, M16			1,8			
HLWC1 - Hollow lightweight concrete brick Hbl, 16DF (ETA data)								
$N_{Rd,p} = N_{Rd,b}$ ($c \geq 125$ mm)	HIT-V + HIT-SC	M8, M10	≥ 80	2	1,4	1,2	1,6	1,2 (1,4 ^a)
	HIT-IC + HIT-SC	M8		6	2,4	2,0	2,6 (2,8 ^a)	2,2 (2,4 ^a)
	HIT-V + HIT-SC HIT-IC + HIT-SC	M12, M16 M10, M12	≥ 80	2	1,6	1,4	1,8	1,4 (1,6 ^a)
				6	2,8	2,4	3,2	2,6 (2,8 ^a)
$V_{Rd,b}$ ($c \geq 250$ mm)	HIT-V + HIT-SC HIT-IC + HIT-SC	M8, M10 M8	≥ 80	2	1,6			
				6	2,6			
	HIT-V + HIT-SC HIT-IC + HIT-SC	M12 M10		2	2,2			
				6	3,8			
	HIT-V + HIT-SC HIT-IC + HIT-SC	M16 M12		2	2,4			
				6	4,0			
HLWC2 - Hollow lightweight concrete brick Germany - Hbl 2, 10DF (Hilti data)								
$N_{Rd,p} = N_{Rd,b}$ ($c \geq 50$ mm)	HIT-V + HIT-SC	M8, M10, M12, M16	≥ 80	2	0,6	0,5	0,6	0,5 (0,6 ^a)
	HIT-IC + HIT-SC	M8, M10, M12						
$V_{Rd,b}$ ($c \geq 250$ mm)	HIT-V + HIT-SC	M8, M10, M12, M16	≥ 80	2	0,6			
	HIT-IC + HIT-SC	M8, M10, M12						







a) Compressed Air Cleaning only

Design tension and shear resistances – Pull-out failure of the anchor, brick breakout failure and local brick failure at edge distance ($c \geq c^*$) for single anchor applications

Load type	Anchor size	h_{ef} [mm]	f_b [N/mm ²]	w/w and w/d		d/d			
				Ta	Tb	Ta	Tb		
Loads [kN]									
 HLWC3 - Hollow lightweight concrete brick Germany - Hbl 4, 8DF (Hilti data)									
$N_{Rd,p} = N_{Rd,b}$ ($c \geq 50$ mm)	HIT-V + HIT-SC	M8, M10, M12, M16	≥ 80	4	0,6	0,6	0,8	0,6	
	HIT-IC + HIT-SC	M8, M10, M12							
$V_{Rd,b}$ ($c \geq 250$ mm)	HIT-V + HIT-SC	M8, M10, M12, M16	≥ 80	4	1,4				
	HIT-IC + HIT-SC	M8, M10, M12							
 SNWC1 - Solid normal weight concrete brick Vbn, 2DF (ETA data)									
$N_{Rd,p} = N_{Rd,b}$ ($c \geq 115$ mm)	HIT-V	M8, M10, M12, M16	$\geq 80^{b)}$	6	1,2	1,0	1,2	1,0	
	HIT-V + HIT-SC	M8, M10, M12, M16							
	HIT-IC	M8, M10, M12							
	HIT-IC + HIT-SC	M8, M10, M12							
$V_{Rd,b}$ ($c \geq 115$ mm)	HIT-V	M8, M10, M12, M16	$\geq 80^{b)}$	6	1,6				
	HIT-V + HIT-SC	M8, M10, M12, M16							
	HIT-IC	M8, M10, M12			16	2,6			
	HIT-IC + HIT-SC	M8, M10, M12							
 SNWC2 - Solid normal weight concrete brick UK Dense concrete b=100 mm (Hilti data)									
$N_{Rd,p} = N_{Rd,b}$ ($c \geq 115$ mm)	HIT-V	M8, M10, M12, M16	50	14	2,2	1,8	2,2	1,8	
	HIT-V + HIT-SC	M8, M10, M12, M16							
$V_{Rd,b}$ ($c \geq 115$ mm)	HIT-V	M8, M10, M12, M16	50	14	4,2				
	HIT-V + HIT-SC	M8, M10, M12, M16							
 SNWC3 - Solid normal weight concrete brick UK Dense concrete b=140 mm (Hilti data)									
$N_{Rd,p} = N_{Rd,b}$ ($c \geq 115$ mm)	HIT-V	M8, M10, M12, M16	≥ 50	14	2,2	1,8	2,2	1,8	
	HIT-V + HIT-SC	M8, M10, M12, M16							
	HIT-IC	M8, M10, M12							
	HIT-IC + HIT-SC	M8, M10, M12							
$V_{Rd,b}$ ($c \geq 115$ mm)	HIT-V	M8, M10, M12, M16	50	14	4,2				
	HIT-V + HIT-SC	M8, M10, M12, M16							
	HIT-V	M8, M10	80	14	4,2				
	HIT-V + HIT-SC	M8, M10							
	HIT-V	M12, M16			4,8				
	HIT-V + HIT-SC	M12, M16							
HIT-IC	M8, M10, M12								
HIT-IC + HIT-SC	M8, M10, M12								
 HNWC1 - Hollow normal weight concrete brick Parpaing creux (ETA data)									
$N_{Rd,p} = N_{Rd,b}$ ($c \geq 50$ mm)	HIT-V + HIT-SC	M8, M10, M12, M16	≥ 50	4	0,36	0,36	0,36	0,36	
	HIT-IC + HIT-SC	M8, M10, M12		10	0,8	0,6	0,8	0,6	
	HIT-V + HIT-SC	M8, M10, M12, M16	≥ 130	4	0,6	0,5	0,6	0,5	
				10	1,0	0,8	1,0	0,8	
$V_{Rd,b}$ ($c \geq 200$ mm)	HIT-V + HIT-SC	M8, M10, M12, M16	≥ 50	4	1,6				
				10	2,6				
	HIT-V + HIT-SC	M8, M10, M12, M16	≥ 80	4	2,0				
				10	3,0				

a) Compressed Air Cleaning only
b) ≥ 50 mm for HIT-V without HIT-SC

Design tension and shear resistances – Pull-out failure of the anchor, brick breakout failure and local brick failure at edge distance ($c \geq c^*$) for single anchor applications

Load type	Anchor size	h_{ef} [mm]	f_b [N/mm ²]	w/w and w/d		d/d	
				Ta	Tb	Ta	Tb
Loads [kN]							
 HNWC2 - Hollow normal weight concrete brick Italy Blocchi Cem (Hilti data)							
$N_{Rd,p} = N_{Rd,b}$ ($c \geq 50$ mm)	HIT-V + HIT-SC M8, M10, M12, M16 HIT-IC + HIT-SC M8, M10, M12	≥ 50	8	1,0	0,8	1,0	0,8
$V_{Rd,b}$ ($c \geq 200$ mm)	HIT-V + HIT-SC M8, M10 HIT-IC + HIT-SC M8	≥ 50	8	4,0			
	HIT-V + HIT-SC M12, M16 HIT-IC + HIT-SC M10, M12			4,4			
 HNWC3 - Hollow normal weight concrete brick Germany Hbn 4, 12DF (Hilti data)							
$N_{Rd,p} = N_{Rd,b}$ ($c \geq 50$ mm)	HIT-V + HIT-SC M8, M10, M12, M16 HIT-IC + HIT-SC M8, M10, M12	≥ 80	4	0,6	0,5	0,6	0,5
			10	1,0	0,8	1,0	0,8
$V_{Rd,b}$ ($c \geq 240$ mm)	HIT-V + HIT-SC M8, M10, M12, M16 HIT-IC + HIT-SC M8, M10, M12	≥ 80	4	2,2			
			10	3,6			
 HNWC4 - Hollow normal weight concrete brick UK (b=215 mm) (Hilti data)							
$N_{Rd,p} = N_{Rd,b}$ ($c \geq 50$ mm)	HIT-V + HIT-SC M8 HIT-V + HIT-SC M10, M12, M16	80	10	0,4	0,4	0,4	0,4
				1,0	0,8	1,0	0,8
$V_{Rd,b}$ ($c \geq 220$ mm)	HIT-V + HIT-SC M8	80	10	1,4			
	HIT-V + HIT-SC M10		2,0				
	HIT-V + HIT-SC M12, M16		2,8				
 HNWC5 - Hollow normal weight concrete brick UK (b=138 mm) (Hilti data)							
$N_{Rd,p} = N_{Rd,b}$ ($c \geq 50$ mm)	HIT-V + HIT-SC M8 HIT-V + HIT-SC M10, M12, M16	80	13	0,6	0,6	0,6	0,6
				1,0	0,8	1,0	0,8
$V_{Rd,b}$ ($c \geq 220$ mm)	HIT-V + HIT-SC M8	80	13	1,4			
	HIT-V + HIT-SC M10		2,0				
	HIT-V + HIT-SC M12, M16		2,8				
 HNWC6 - Hollow normal weight concrete brick UK (b=112 mm) (Hilti data)							
$N_{Rd,p} = N_{Rd,b}$ ($c \geq 50$ mm)	HIT-V + HIT-SC M8 HIT-V + HIT-SC M10, M12, M16	50	7	0,6	0,6	0,6	0,6
				1,0	0,8	1,0	0,8
$V_{Rd,b}$ ($c \geq 100$ mm)	HIT-V + HIT-SC M8	50	7	1,4			
	HIT-V + HIT-SC M10		2,0				
	HIT-V + HIT-SC M12, M16		2,8				
 HNWC7 - Hollow normal weight concrete brick Finland "Standard Concrete Brick" (Hilti data)							
$N_{Rd,p} = N_{Rd,b}$ ($c \geq 50$ mm)	HIT-V + HIT-SC M8, M10 HIT-V + HIT-SC M12, M16	50	6	0,6	0,4	0,6	0,4
				0,8	0,6	0,8	0,6
$V_{Rd,b}$ ($c \geq 100$ mm)	HIT-V + HIT-SC M8	50	6	1,0			
	HIT-V + HIT-SC M10		1,4				
	HIT-V + HIT-SC M12, M16		1,6				
 HNWC8 - Hollow normal weight concrete brick AUS Block system 200 (Hilti data)							
$N_{Rd,p} = N_{Rd,b}$ ($c \geq 50$ mm)	HIT-V + HIT-SC M8, M10, M12, M16 HIT-IC + HIT-SC M8, M10, M12	≥ 50	15	1,0	0,8	1,0	0,8
$V_{Rd,b}$ ($c \geq 200$ mm)	HIT-V + HIT-SC M8, M10	≥ 50	15	2,0			
	HIT-V + HIT-SC M12, M16 HIT-IC + HIT-SC M8, M10, M12			3,2			

a) Compressed Air Cleaning only

Masonry

Chemical anchors

Mechanical anchors

Plastic/Light duty metal anchors

Insulation anchors

Design tension and shear resistance – Pull out / Pushing out of one brick failure modes

Pull out of one brick (tension):

$$N_{Rd,pb} = 2 \cdot l \cdot b \cdot (0,5 \cdot f_{vko} + 0,4 \cdot \sigma_d) / (2,5 \cdot 1000) \quad [\text{kN}]$$

$$N_{Rd,pb} = (2 \cdot l \cdot b \cdot (0,5 \cdot f_{vko} + 0,4 \cdot \sigma_d) + b \cdot h \cdot f_{vko}) / (2,5 \cdot 1000) \quad [\text{kN}]$$

* this equation is applicable if the vertical joints are filled

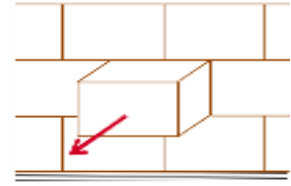

Pushing out of one brick (shear):

$$V_{Rd,pb} = 2 \cdot l \cdot b \cdot (0,5 \cdot f_{vko} + 0,4 \cdot \sigma_d) / (2,5 \cdot 1000) \quad [\text{kN}]$$

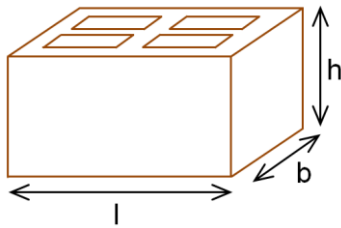
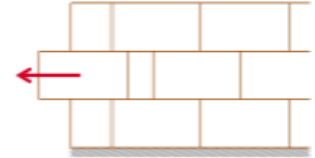

σ_d = design compressive stress perpendicular to the shear (N/mm²)
 f_{vko} = initial shear strength according to EN 1996-1-1, Table 3.4

Brick type	Mortar strength	f_{vko} [N/mm ²]
Clay brick	M2,5 to M9	0,20
	M10 to M20	0,30
All other types	M2,5 to M9	0,15
	M10 to M20	0,20

On-site tests



For other bricks in solid or hollow masonry, not covered by the Hilti HIT-HY 270 ETA or this technical data manual, the characteristic resistance may be determined by on-site tension tests (pull-out tests or proof-load tests), according to ETAG029, Annex B.

For the evaluation of test results, the characteristic resistance may be obtained taking into account the β factor, which considers the different influences of the product.

The β factor for the brick types covered by the Hilti HIT-HY 270 ETA is provided on the following table:

Use categories		w/w and w/d		d/d	
Temperature range		Ta*	Tb*	Ta*	Tb*
Base material	Cleaning				
Solid clay brick EN 771-1	CAC	0,96	0,96	0,96	0,96
	MC	0,84	0,84	0,84	0,84
Solid calcium silicate brick EN 771-2	CAC/MC	-	-	0,96	0,80
Solid light weight concrete brick EN 771-3	CAC	0,82	0,68	0,96	0,80
	MC	0,81	0,67	0,90	0,75
Solid normal weight concrete brick EN 771-3	CAC/MC	0,96	0,80	0,96	0,80
Hollow clay brick EN 771-1	CAC	0,96	0,96	0,96	0,96
	MC	0,84	0,84	0,84	0,84
Hollow calcium silicate brick EN 771-2	CAC/MC	-	-	0,96	0,80
Hollow light weight concrete brick EN 771-3	CAC	0,69	0,57	0,81	0,67
	MC	0,68	0,56	0,76	0,63
Hollow normal weight concrete brick EN 771-3	CAC/MC	0,96	0,80	0,96	0,80

*Ta / Tb, w/w and d/d anchorage parameters, as defined on Table page 9

Applying the β factor from the table above, the characteristic tension resistance N_{Rk} can be obtained. Characteristic shear resistance V_{Rk} can also be directly derived from N_{Rk} . For detailed procedure consult ETAG 029, Annex B.

Materials

Material quality

Part	Material
Threaded rod HIT-V 5.8 (F)	Strength class 5.8, A5 > 8% ductile Electroplated zinc coated $\geq 5 \mu\text{m}$; (F) Hot dip galvanized $\geq 45 \mu\text{m}$
Threaded rod HIT-V 8.8 (F)	Strength class 8.8, A5 > 8% ductile Electroplated zinc coated $\geq 5 \mu\text{m}$; (F) Hot dip galvanized $\geq 45 \mu\text{m}$
Threaded rod HIT-V-R	Stainless steel grade A4 A5 > 8% ductile strength class 70, 1.4401; 1.4404; 1.4578; 1.4571; 1.4439; 1.4362
Threaded rod HIT-V-HCR	High corrosion resistant steel, A5 > 8% ductile 1.4529, 1.4565
Washer	Electroplated zinc coated, hot dip galvanized
	Stainless steel 1.4401; 1.4404; 1.4578; 1.4571; 1.4439; 1.4362
	High corrosion resistant steel 1.4529, 1.4565 EN 10088
Nut	Strength class 8 steel galvanized $\geq 5 \mu\text{m}$, ; hot dipped galvanized $\geq 45 \mu\text{m}$
	Strength class 70, stainless steel grade A4, 1.4401; 1.4404; 1.4578; 1.4571; 1.4439; 1.4362
	Strength class 70, high corrosion resistant steel, 1.4529; 1.4565
Internally threaded sleeve HIT-IC	A5 > 8% ductile ; Electroplated zinc coated $\geq 5 \mu\text{m}$
Sieve sleeve HIT-SC	Frame: Polyfort FPP 20T ; Sieve: PA6.6 N500/200

Base materials:

- Solid brick masonry. The resistances are also valid for larger brick sizes and larger compressive strengths of the masonry unit.
- Hollow brick masonry
- Mortar strength class of the masonry: M2,5 at minimum according to EN 998-2: 2010.
- For other bricks in solid masonry and in hollow or perforated masonry, the characteristic resistance of the anchor may be determined by on-site tests according to ETAG 029, Annex B under consideration of the β -factor according to the table on page 21.

Installation parameters

Applications for hollow and solid bricks with sieve sleeves

For installing HIT-V and HIT-IC with embedments of 50 and 80 mm, a single sieve sleeve is used.

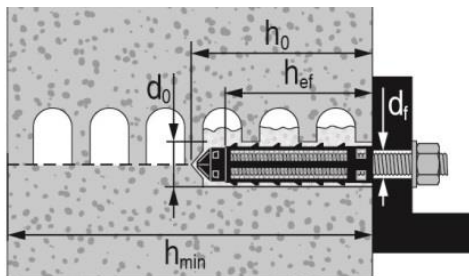

Hollow brick with threaded rod HIT-V or internally threaded sleeve HIT-IC and a single sieve sleeve HIT-SC

Installation parameters of HIT-V with one sieve sleeve HIT-SC in hollow and solid brick

HIT-V		M6	M8		M10		M12		M16	
with HIT-SC		12x85	16x50	16x85	16x50	16x85	18x50	18x85	22x50	22x85
Nominal diameter of drill bit	d_0 [mm]	12	16	16	16	16	18	18	22	22
Drill hole depth	h_0 [mm]	95	60	95	60	95	60	95	60	95
Effective embedment depth	h_{ef} [mm]	80	50	80	50	80	50	80	50	80
Maximum diameter of clearance hole in the fixture	d_f [mm]	7	9	9	12	12	14	14	18	18
Minimum wall thickness	h_{min} [mm]	115	80	115	80	115	80	115	80	115
Brush HIT-RB	- [-]	12	16	16	16	16	18	18	22	22
Number of strokes HDM	- [-]	5	4	6	4	6	4	8	6	10
Nr. of strokes HDE 500-A	- [-]	4	3	5	3	5	3	6	5	8
Max. torque moment for all brick types except "parpaing creux"	T_{max} [Nm]	0	3	3	4	4	6	6	8	8
Maximum torque moment for "parpaing creux"	T_{max} [Nm]	-	2	2	2	2	3	3	6	6

Installation parameters of HIT-IC with HIT-SC in hollow and solid brick

HIT-IC		M8	M10	M12
with HIT-SC		16x85	18x85	22x85
Nominal diameter of drill bit	d_0 [mm]	16	18	22
Drill hole depth	h_0 [mm]	95	95	95
Effective embedment depth	h_{ef} [mm]	80	80	80
Thread engagement length	h_s [mm]	8...75	10...75	12...75
Maximum diameter of clearance hole in the fixture	d_f [mm]	9	12	14
Minimum wall thickness	h_{min} [mm]	115	115	115
Brush HIT-RB	- [-]	16	18	22
Number of strokes HDM	- [-]	6	8	10
Number of strokes HDE-500	- [-]	5	6	8
Maximum torque moment	T_{max} [Nm]	3	4	6

Applications for hollow and solid bricks with sieve sleeves (cont.)

For installing HIT-V and HIT-IC with embedments of 130 and 160 mm, two attached sleeves HIT-SC are used.

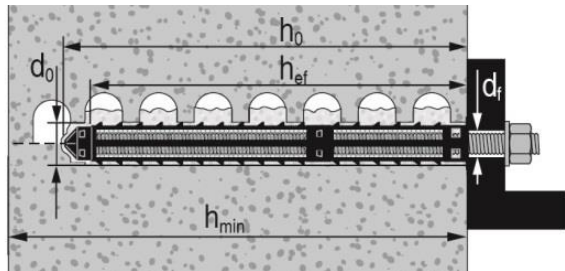

Hollow brick with threaded rod HIT-V and two sieve sleeves HIT-SC for deeper embedment depth

Installation parameters of HIT-V with two attached sleeves HIT-SC in hollow and solid brick

HIT-V		M8		M10		M12		M16	
with HIT-SC		16x50 +	16x85 +	16x50 +	16x85 +	18x50 +	18x85 +	22x50 +	22x85 +
		16x85	16x85	16x85	16x85	18x85	18x85	22x85	22x85
Nominal diameter of drill bit	d_0 [mm]	16	16	16	16	18	18	22	22
Drill hole depth	h_0 [mm]	145	180	145	180	145	180	145	180
Effective embedment depth	h_{ef} [mm]	130	160	130	160	130	160	130	160
Maximum diameter of clearance hole in the fixture	d_{fr} [mm]	9	9	12	12	14	14	18	18
Minimum wall thickness	h_{min} [mm]	195	230	195	230	195	230	195	230
Brush HIT-RB	- [-]	16	16	16	16	18	18	22	22
Number of strokes HDM	- [-]	4+6	6+6	4+6	6+6	4+8	8+8	6+10	10+10
Number of strokes HDE-500	- [-]	3+5	5+5	3+5	5+5	3+6	6+6	5+8	8+8
Maximum torque moment	T_{max} [Nm]	3	3	4	4	6	6	8	8

Applications for hollow and solid bricks with sieve sleeves (cont.)

For through fastenings with HIT-V, two attached sleeves HIT-SC are used.

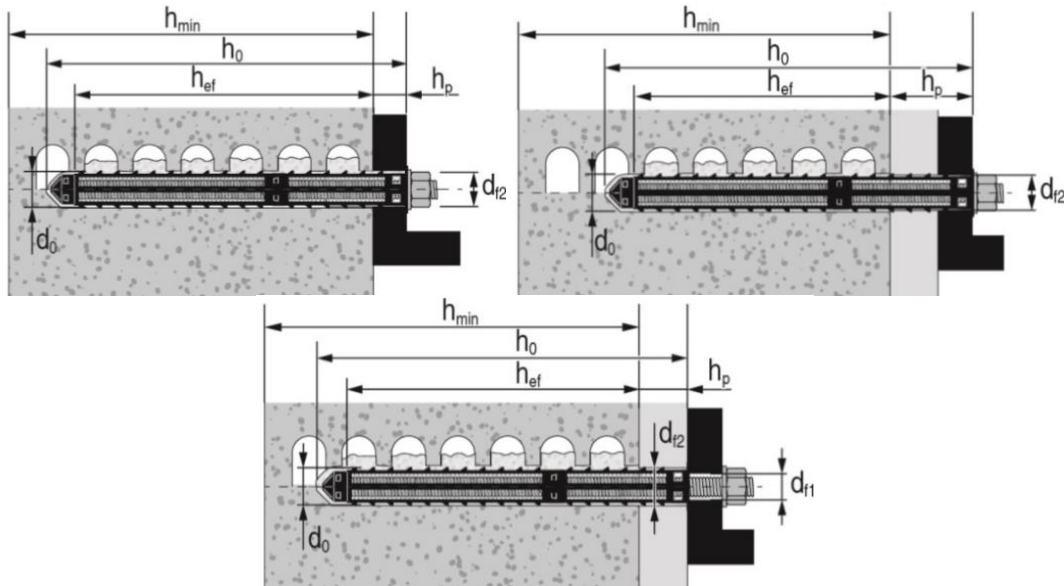

Hollow and solid brick with threaded rod HIT-V with two sieve sleeves HIT-SC for setting through the fixture and/or through the non-loadbearing layer

Installation parameters of HIT-V with two sieve sleeves through the fixture and/or through the non-loadbearing layer in hollow and solid bricks

HIT-V		M8		M10		M12		M16	
with HIT-SC		16x50 + 16x85	16x85 + 16x85	16x50 + 16x85	16x85 + 16x85	18x50 + 18x85	18x85 + 18x85	22x50 + 22x85	22x85 + 22x85
Nominal diameter of drill bit	d_0 [mm]	16	16	16	16	18	18	22	22
Drill hole depth	h_0 [mm]	145	180	145	180	145	180	145	180
Effective embedment depth	$h_{ef,min}$ [mm]	80	80	80	80	80	80	80	80
Max. thickness of non-loadbearing layer and fixture (through setting)	$h_{p,max}$ [mm]	50	80	50	80	50	80	50	80
Max. diameter of clearance hole in the fixture (pre-setting)	d_{r1} [mm]	9	9	12	12	14	14	18	18
Max. diameter of clearance hole in fixture (through setting)	d_{r2} [mm]	17	17	17	17	19	19	23	23
Minimum wall thickness	h_{min} [mm]	$h_{ef}+65$	$h_{ef}+70$	$h_{ef}+65$	$h_{ef}+70$	$h_{ef}+65$	$h_{ef}+70$	$h_{ef}+65$	$h_{ef}+70$
Brush HIT-RB	- [-]	16	16	16	16	18	18	22	22
Number of strokes HDM	- [-]	4+6	6+6	4+6	6+6	4+8	8+8	6+10	10+10
Number of strokes HDE	- [-]	3+5	5+5	3+5	5+5	5+8	8+8	5+8	8+8
Max. torque moment for all brick types except "parpaing creux"	T_{max} [Nm]	3	3	4	4	6	6	8	8
Max. torque moment for "parpaing creux"	T_{max} [Nm]	2	2	2	2	3	3	6	6

Applications for solid bricks without sieve sleeves.

Hilti recommends the anchoring in masonry always with sieve sleeve. Anchors can only be installed without sieve sleeves in solid bricks when it is guaranteed that it has not any hole or void.

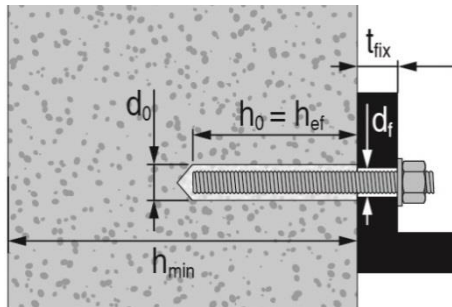

Solid brick with threaded rod HIT-V

Installation parameters of HIT-V in solid bricks

Threaded rods and HIT-V		M8	M10	M12	M16
Nominal diameter of drill bit	d_0 [mm]	10	12	14	18
Drill hole depth = Effective embedment depth	$h_0 = h_{ef}$ [mm]	50...300	50...300	50...300	50...300
Maximum diameter of clearance hole in the fixture	d_f [mm]	9	12	14	18
Minimum wall thickness	h_{min} [mm]	h_0+30	h_0+30	h_0+30	h_0+36
Brush HIT-RB	- [-]	10	12	14	18
Maximum torque moment	T_{max} [Nm]	5	8	10	10

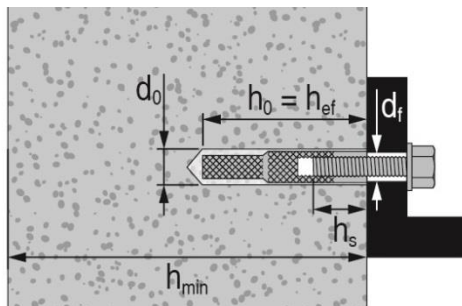

Solid brick with internal threaded sleeve HIT-IC

Installation parameters of HIT-IC in solid bricks

HIT-IC		M8x80	M10x80	M12x80
Nominal diameter of drill bit	d_0 [mm]	14	16	18
Drill hole depth = Effective embedment depth	$h_0 = h_{ef}$ [mm]	80	80	80
Thread engagement length	h_s [mm]	8...75	10...75	12...75
Maximum diameter of clearance hole in the fixture	d_f [mm]	9	12	14
Minimum wall thickness	h_{min} [mm]	115	115	115
Brush HIT-RB	- [-]	14	16	18
Maximum torque moment	T_{max} [Nm]	5	8	10

Installation equipment

Anchor size	M6	M8	M10	M12	M16
Rotary hammer	TE2(A) – TE30(A)				
Other tools	compressed air gun or blow out pump, set of cleaning brushes, dispenser				

Drilling and cleaning parameters

HIT-V ^{a)}	HIT-V + sieve sleeve	HIT-IC ^{a)}	HIT-IC + sieve sleeve	Hammer drill	Brush HIT-RB
				d_0 [mm]	size [mm]
-	-	-	-	8	8
M8	-	-	-	10	10
M10	-	-	-	12	12
M12	-	M8	-	14	14
-	M8	M10	M8	16	16
-	M10	-	-	16	16
M16	M12	M12	M10	18	18
-	M16	-	M12	22	22

a) Installation without the sieve sleeve HIT-SC can be used only in case of solid bricks.

Setting instructions

*For detailed information on installation see instruction for use given with the package of the product.



Safety regulations.

Review the Material Safety Data Sheet (MSDS) before use for proper and safe handling! Wear well-fitting protective goggles and protective gloves when working with Hilti HIT-HY 270.

Drilling

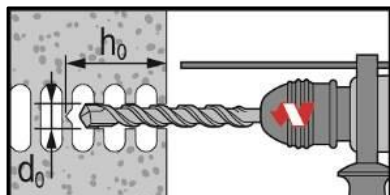

In hollow bricks: rotary mode

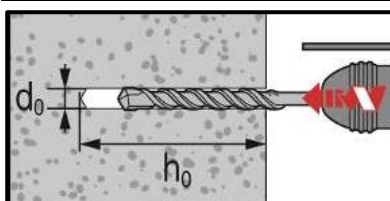

In solid bricks: hammer mode

Cleaning

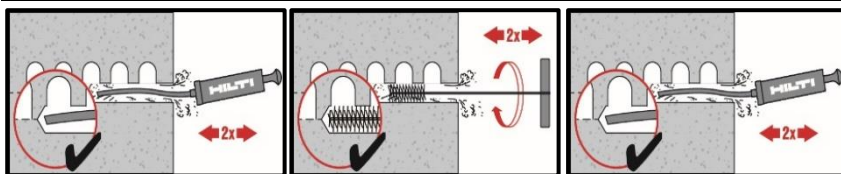

Manual cleaning (MC)

For drill hole diameter $d_0 \leq 18$ mm and drill hole depth $h_0 \leq 100$ mm

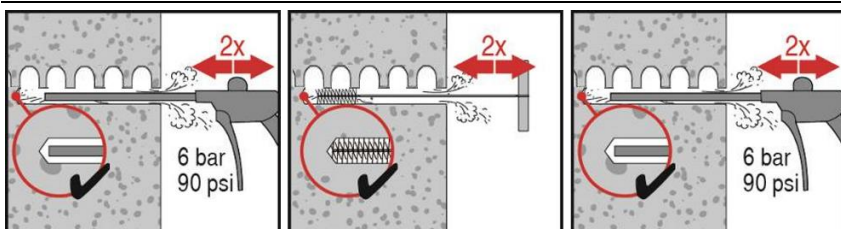

Compressed air cleaning (CAC)

For drill hole depth $h_0 \leq 300$ mm

Injection preparation for hollow and solid bricks with sieve sleeve

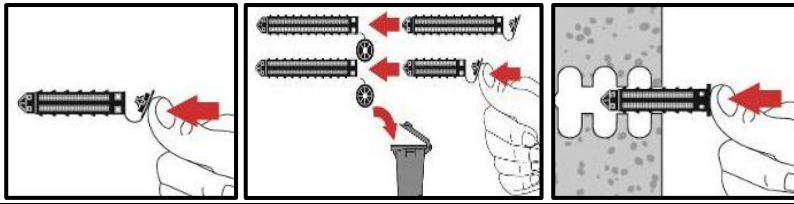

Close lid and insert sieve sleeve manually.

All applications

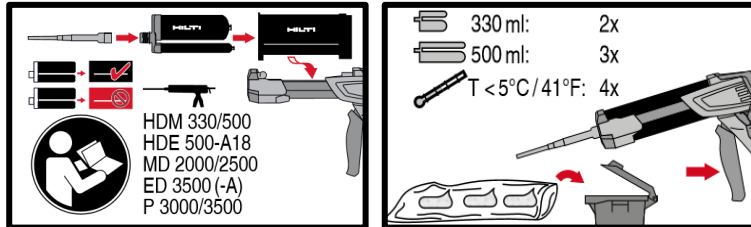

Injection system preparation.

Inject the adhesive without forming air voids

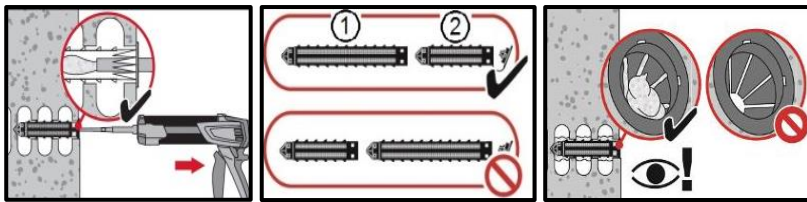

Injection method 1 for Installation with sieve sleeve HIT-SC. Use extension for installation with two sieve sleeves.

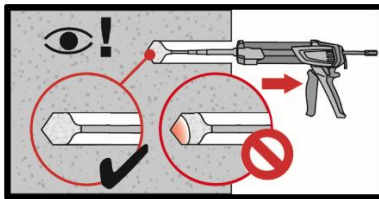

Injection method 2 for installation in solid bricks without sieve sleeve

Setting de element

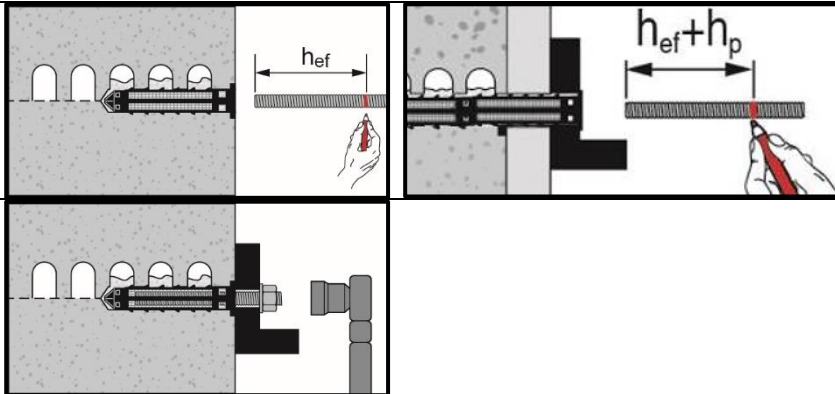

Marking and setting element, to the required embedment depth, observing working time t_{work} .

Loading the anchor: After required curing time t_{cure} the anchor can be loaded. The applied installation torque shall not exceed the values T_{max} .



Masonry

Chemical anchors

Mechanical anchors

Plastic/Light duty metal anchors

Insulation anchors

HDA Undercut anchor

Ultimate-performance undercut anchor for dynamic loads

Anchor version



HDA-P
HDA-PR
HDA-PF
Anchor for pre-setting (M10-M20)



HDA-T
HDA-TR
HDA-TF
Anchor for through-fastening (M10-M20)

Benefits

- Safe and high performance structural seismic design with ETA C1 and C2
- Mechanical interlock (undercut)
- Low expansion force (thus small edge distance / spacing)
- Self undercutting (without special undercutting tool)
- Performance of a headed stud
- Complete system (anchor, stop drill bit, setting tool, drill hammer)
- Setting mark on anchor for control (easy and safe)
- Completely removable

Base material



Concrete (non-cracked)



Concrete (cracked)

Load conditions



Static/
quasi-static



Seismic
ETA-C1, C2

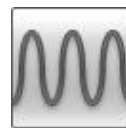

Fatigue



Shock



Fire
resistance

Installation conditions



Hammer
drilled holes

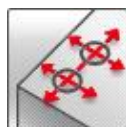

Small edge
distance
and spacing



Performance
of a headed
stud

Other information



European
Technical
Assessment



CE
conformity



PROFIS
design
Software



Nuclear power
plant approval

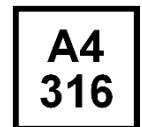

Corrosion
resistance

Approvals / certificates

Description	Authority / Laboratory	No. / date of issue
European Technical Assessment ^{a)}	CSTB, Paris	ETA-99/0009 / 2015-01-06
ICC-ES report incl. seismic ^{b)}	ICC evaluation service	ESR 1546 / 2014-02-01
Shockproof fastenings in civil defence installations	Federal Office for Civil Protection, Bern	BZS D 09-601/ 2009-10-21
Nuclear power plants	DIBt, Berlin	Z-21.1-1987 / 2014-07-22
Fatigue loading	DIBt, Berlin	Z-21.1-1693 / 2013-07-29
Fire assessment report	Warringtonfire	WF 327804/A 2016-05-3

a) All data for HDA-P(R) and HDA-T(R) given in this section according ETA-99/0009, issue 2015-01-06.

Sherdardized versions HDA-PF and HDA-TF anchors are not covered by the approvals.

b) For more details on Technical Data according to ICC please consult the relevant HNA FTM.

Static and quasi-static resistance (for a single anchor)

All data in this section applies to:

- Correct setting (See setting instruction)
- No edge distance and spacing influence
- Steel failure
- Minimum base material thickness
- Concrete C 20/25, $f_{ck,cube} = 25 \text{ N/mm}^2$

Effective anchorage depth for static

Anchor size	M10	M12	M16	M20
Eff. Anchorage depth h_{ef} [mm]	100	125	190	250

Characteristic resistance

Anchor size		M10	M12	M16	M20 ^{a)}											
Non-cracked concrete																
Tension N_{Rk}	HDA-P(F), HDA-T(F) ^{b)} [kN]	46	67	126	192											
	HDA-PR, HDA-TR	46	67	126	-											
Cracked concrete																
Tension N_{Rk}	HDA-P(F), HDA-T(F) ^{b)} [kN]	25	35	75	95											
	HDA-PR, HDA-TR	25	35	75	-											
Non-cracked and cracked concrete																
Shear V_{Rk}	HDA-T(F) ^{b)}	$t_{fix,min}$ [mm]	10≤	15≤	10≤	15≤	20≤	15≤	20≤	25≤	30≤	35≤	20≤	25≤	40≤	55≤
		$t_{fix,max}$ [mm]	<15	≤20	<15	<20	≤50	<20	<25	<30	<35	≤60	<25	<40	<55	≤100
		V_{Rk} [kN]	65 ^{c)}	70	80	80	100	140 ^{c)}	140	155	170	190	205	205	235	250
	HDA-TR	$t_{fix,min}$ [mm]	10≤	15≤	10≤	15≤	20≤	30≤	15≤	20≤	25≤	35≤				
		$t_{fix,max}$ [mm]	<15	≤20	<15	<20	<30	≤50	<20	<25	<35	≤60				
		V_{Rk} [kN]	71 ^{c)}	71	87	87	94	109	152	152	158	170				
	HDA-P(F) ^{b)} [kN]		22		30		62		92							
	HDA-PR		23		34		63									

- a) HDA M20: only galvanized 5 μ m version is available.
b) HDA-PF and HDA-TF: anchors are not covered by ETA-99/0009.
c) With use of centering washer (t=5mm) only.

Design resistance

Anchor size		M10	M12	M16	M20 ^{a)}											
Non-cracked concrete																
Tension N_{Rd}	HDA-P(F), HDA-T(F) ^{b)} [kN]	30,7	44,7	84,0	128,0											
	HDA-PR, HDA-TR	28,8	41,9	78,8	-											
Cracked concrete																
Tension N_{Rd}	HDA-P(F), HDA-T(F) ^{b)} [kN]	16,7	23,3	50,0	63,3											
	HDA-PR, HDA-TR	16,7	23,3	50,0	-											
Non-cracked and cracked concrete																
Shear V_{Rd}	HDA-T(F) ^{b)}	$t_{fix,min}$ [mm]	10≤	15≤	10≤	15≤	20≤	15≤	20≤	25≤	30≤	35≤	20≤	25≤	40≤	55≤
		$t_{fix,max}$ [mm]	<15	≤20	<15	<20	≤50	<20	<25	<30	<35	≤60	<25	<40	<55	≤100
		V_{Rk} [kN]	43,3 ^{c)}	46,7	53,3 ^{c)}	53,3	66,7	93,3 ^{c)}	93,3	103,3	113,3	126,7	136,7 ^{c)}	136,7	156,7	166,7
	HDA-TR	$t_{fix,min}$ [mm]	10≤	15≤	10≤	15≤	20≤	30≤	15≤	20≤	25≤	35≤				
		$t_{fix,max}$ [mm]	<15	≤20	<15	<20	<30	≤50	<20	<25	<35	≤60				
		V_{Rk} [kN]	53,4 ^{c)}	53,4	65,4 ^{c)}	65,4	70,7	82,0	114,3 ^{c)}	114,3	118,8	127,8				
	HDA-P(F) ^{b)} [kN]		17,6		24,0		49,6		73,6							
	HDA-PR		17,3		25,6		47,4									

- a) HDA M20: only galvanized 5 μ m version is available.
b) HDA-PF and HDA-TF: anchors are not covered by ETA-99/0009.
c) With use of centering washer (t=5mm) only.

Recommended loads ^{d)}

Anchor size		M10	M12	M16				M20 ^{a)}								
Non-cracked concrete																
Tension N_{Rk}	HDA-P(F), HDA-T(F) ^{b)}	21,9	31,9	60,0				91,4								
	HDA-PR, HDA-TR	20,5	29,9	56,3				-								
Cracked concrete																
Tension N_{Rec}	HDA-P(F), HDA-T(F) ^{b)}	11,9	16,7	35,7				45,2								
	HDA-PR, HDA-TR	11,9	16,7	35,7				-								
Non-cracked and cracked concrete																
Shear V_{Rec}	HDA-T(F) ^{b)}	$t_{fix,min}$ [mm]	10≤	15≤	10≤	15≤	20≤	15≤	20≤	25≤	30≤	35≤	20≤	25≤	40≤	55≤
		$t_{fix,max}$ [mm]	<15	≤20	<15	<20	≤50	<20	<25	<30	<35	≤60	<25	<40	<55	≤100
	V_{Rk} [kN]	31 ^{c)}	31	38 ^{c)}	38	38	67 ^{c)}	67	74	81	90	98 ^{c)}	98	112	119	
	HDA-TR	$t_{fix,min}$ [mm]	10≤	15≤	10≤	15≤	20≤	30≤	15≤	20≤	25≤	35≤	-			
		$t_{fix,max}$ [mm]	<15	≤20	<15	<20	<30	≤50	<20	<25	<35	≤60	-			
		V_{Rk} [kN]	38 ^{c)}	38	47 ^{c)}	47	50	59	82 ^{c)}	82	85	91	-			
	HDA-P(F) ^{b)}		12,6		17,1				35,4				52,6			
	HDA-PR		12,3		18,2				33,8				-			

- a) HDA M20: only galvanized 5µm version is available.
b) HDA-PF and HDA-TF: anchors are not covered by ETA-99/0009
c) With use of centering washer (t=5mm) only
d) With overall partial safety factor for action $\gamma_F = 1,4$. The partial safety factors for action depend on the type of loading.

Seismic resistance
All data in this section applies to:

- Correct setting (See setting instruction with a drilling hammer)
- No edge distance and spacing influence
- *Steel* failure
- Minimum base material thickness
- Concrete C 20/25, $f_{ck,cube} = 25 \text{ N/mm}^2$
- $\alpha_{gap} = 1,0$ (using Hilti seismic filling set)

Effective anchorage depth for seismic C2 and C1

Anchor size	M10	M12	M16	M20
Eff. Anchorage depth h_{ef} [mm]	100	125	190	250

Characteristic resistance in case of seismic performance category C2

Anchor size		M10	M12	M16				M20 ^{a)}								
Tension $N_{Rk,seis}$	HDA-P, HDA-T	25	35	75				95								
	HDA-PR, HDA-TR	25	35	75				-								
Shear $V_{Rk,seis}$	HDA-T	$t_{fix,min}$ [mm]	10≤	15≤	10≤	15≤	20≤	15≤	20≤	25≤	30≤	35≤	20≤	25≤	40≤	55≤
		$t_{fix,max}$ [mm]	<15	≤20	<15	<20	≤50	<20	<25	<30	<35	≤60	<25	<40	<55	≤100
	V_{Rk} [kN]	39	42	56	56	70	84	84	93	102	112	144	144	165	175	
	HDA-TR	$t_{fix,min}$ [mm]	10≤	15≤	10≤	15≤	20≤	30≤	15≤	20≤	25≤	35≤	-			
		$t_{fix,max}$ [mm]	<15	≤20	<15	<20	<30	≤50	<20	<25	<35	≤60	-			
		V_{Rk} [kN]	21,5	21,5	30,5	30,5	33,0	38,0	45,5	45,5	47,5	51	-			
	HDA-P		20		24				56				83			
	HDA-PR		10,5		13,5				28,5				-			

- a) HDA M20: only galvanized 5µm version is available

Design resistance in case of seismic performance category C2

Anchor size		M10	M12				M16				M20 ^{a)}					
Tension $N_{Rd,seis}$	HDA-P, HDA-T [kN]	16,7	23,3				50				63,3					
	HDA-PR, HDA-TR [kN]	16,7	23,3				50				-					
Shear $V_{Rd,seis}$	HDA-T	$t_{fix,min}$ [mm]	10≤	15≤	10≤	15≤	20≤	15≤	20≤	25≤	30≤	35≤	20≤	25≤	40≤	55≤
		$t_{fix,max}$ [mm]	<15	≤20	<15	<20	≤50	<20	<25	<30	<35	≤60	<25	<40	<55	≤100
		V_{Rk} [kN]	26	28	37,3	37,3	46,7	56	56	62	68	74,7	96	96	110	116,7
	HDA-TR	$t_{fix,min}$ [mm]	10≤	15≤	10≤	15≤	20≤	30≤	15≤	20≤	25≤	35≤	-			
		$t_{fix,max}$ [mm]	<15	≤20	<15	<20	<30	≤50	<20	<25	<35	≤60	-			
		V_{Rk} [kN]	16,2	16,2	22,9	22,9	24,8	28,6	34,2	34,2	35,7	38,3	-			
	HDA-P [kN]	16	19,2				44,8				66,4					
	HDA-PR [kN]	7,9	10,2				21,4				-					

a) HDA M20: only galvanized 5µm version is available

Characteristic resistance in case of seismic performance category C1

Anchor size		M10	M12				M16				M20 ^{a)}					
Tension $N_{Rk,seis}$	HDA-P, HDA-T [kN]	41,5	58				108,7				164					
	HDA-PR, HDA-TR [kN]	41,5	58				108,7				-					
Shear $V_{Rk,seis}$	HDA-T	$t_{fix,min}$ [mm]	10≤	15≤	10≤	15≤	20≤	15≤	20≤	25≤	30≤	35≤	20≤	25≤	40≤	55≤
		$t_{fix,max}$ [mm]	<15	≤20	<15	<20	≤50	<20	<25	<30	<35	≤60	<25	<40	<55	≤100
		V_{Rk} [kN]	65	70	80	80	100	140	140	155	170	190	205	205	235	250
	HDA-TR	$t_{fix,min}$ [mm]	10≤	15≤	10≤	15≤	20≤	30≤	15≤	20≤	25≤	35≤	-			
		$t_{fix,max}$ [mm]	<15	≤20	<15	<20	<30	≤50	<20	<25	<35	≤60	-			
		V_{Rk} [kN]	35,5	35,5	43,5	43,5	47	54,5	76	76	79	85	-			
	HDA-P [kN]	20	22				30				62					
	HDA-PR [kN]	10,5	11,5				17				31,5					

a) HDA M20: only galvanized 5µm version is available

Design resistance in case of seismic performance category C1

Anchor size		M10	M12				M16				M20 ^{a)}					
Tension $N_{Rd,seis}$	HDA-P, HDA-T [kN]	27,7	38,7				72,5				109,4					
	HDA-PR, HDA-TR [kN]	27,7	38,7				72,5				-					
Shear $V_{Rd,seis}$	HDA-T	$t_{fix,min}$ [mm]	10≤	15≤	10≤	15≤	20≤	15≤	20≤	25≤	30≤	35≤	20≤	25≤	40≤	55≤
		$t_{fix,max}$ [mm]	<15	≤20	<15	<20	≤50	<20	<25	<30	<35	≤60	<25	<40	<55	≤100
		V_{Rk} [kN]	43,3	46,7	53,3	53,3	66,7	93,3	93,3	103,3	113,3	126,7	136,7	136,7	156,7	166,7
	HDA-TR	$t_{fix,min}$ [mm]	10≤	15≤	10≤	15≤	20≤	30≤	15≤	20≤	25≤	35≤	-			
		$t_{fix,max}$ [mm]	<15	≤20	<15	<20	<30	≤50	<20	<25	<35	≤60	-			
		V_{Rk} [kN]	26,7	26,7	32,7	32,7	35,3	41	57,1	57,1	59,4	63,9	-			
	HDA-P [kN]	17,6	24				49,6				73,6					
	HDA-PR [kN]	8,6	12,8				23,7				-					

a) HDA M20: only galvanized 5µm version is available

Materials

Mechanical properties of HDA

Anchor size	HDA-P(F), HDA-T(F)				HDA-PR, HDA-TR		
	M10	M12	M16	M20 ^{a)}	M10	M12	M16
Anchor bolt							
Nominal tensile strength f_{uk}	800	800	800	800	800	800	800
Yield strength f_{yk}	640	640	640	640	600	600	600
Stressed cross-section A_s	58,0	84,3	157	245	58,0	84,3	157
Moment of resistance W_{el}	62,3	109,2	277,5	540,9	62,3	109,2	277,5
Characteristic bending resistance without sleeve $M_{Rk,s}^{b)}$	60	105	266	519	60	105	266
Anchor sleeve							
Nominal tensile strength f_{uk}	850	850	700	550	850	850	700
Yield strength f_{yk}	600	600	600	450	600	600	600

a) HDA M20: only a galvanized 5 μ m version is available

b) The recommended bending moment of the HDA anchor bolt may be calculated from $M_{rec} = M_{Rd,s} / \gamma_F = M_{Rk,s} / (\gamma_{MS} \cdot \gamma_F) = (1,2 \cdot W_{el} \cdot f_{uk}) / (\gamma_{MS} \cdot \gamma_F)$, where the partial safety factor for bolts of strength 8.8 is $\gamma_{MS} = 1,25$, for A4-80 equal to 1,33 and the partial safety factor for action may be taken as $\gamma_F = 1,4$. In case of HDA-T/TR/TF the bending capacity of the sleeve is neglected, only the capacity of the bolt is taken into account.

Material quality

Part	Material
HDA-P / HDA-T	
Sleeve:	Machined steel with brazed tungsten carbide tips, galvanized to min. 5 μ m
Bolt M10 - M16:	Cold formed steel, strength 8.8, galvanized to min. 5 μ m
Bolt M20:	Cone machined, rod strength 8.8, galvanized to min. 5 μ m
Washer M10-M16:	Spring washer, galvanized or coated
Washer M20:	Washer, galvanized
Centering washer	Machined steel
HDA-PR / HDA-TR	
Sleeve:	Machined stainless steel with brazed tungsten carbide tips
Bolt M10 - M16:	Cone/rod: machined stainless steel
Washer	Spring washer stainless steel
Centering washer	Machined steel
HDA-PF / HDA-TF	
Sleeve	Machined steel with brazed tungsten carbide tips, sherardized
Bolt M10-M16:	Cold formed steel, strength 8.8, sherardized

Anchor dimensions

Anchor size			HDA-P / HDA-PR / HDA-T / HDA-TR / HDA-PF / HDA-TF							
			M10		M12		M16		M20	
			x100/20	x125/30	x125/50	x190/40	x190/60	x250/50	x250/100	
Length code letter			I	L	N	R	S	V	X	
Total length of bolt	l_B	[mm]	150	190	210	275	295	360	410	
Diameter of bolt	d_B	[mm]	10	12		16		20		
Total length of sleeve										
HDA-P	l_s	[mm]	100	125	125	190	190	250	250	
HDA-T	l_s	[mm]	120	155	175	230	250	300	350	
Max. diameter of sleeve	d_s	[mm]	19	21		29		35		
Washer diameter	d_w	[mm]	27,5	33,5		45,5		50		
Width across flats	S_w	[mm]	17	19		24		30		

HDA-P / HDA-PR

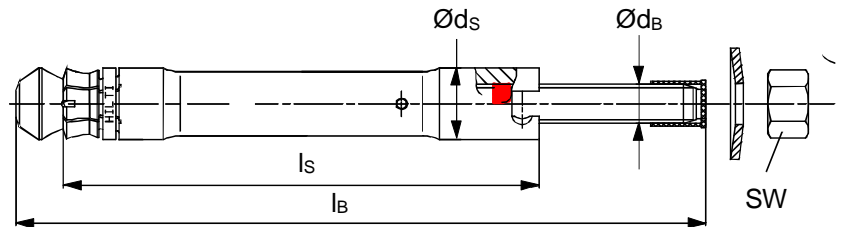

HDA-T / HDA-TR

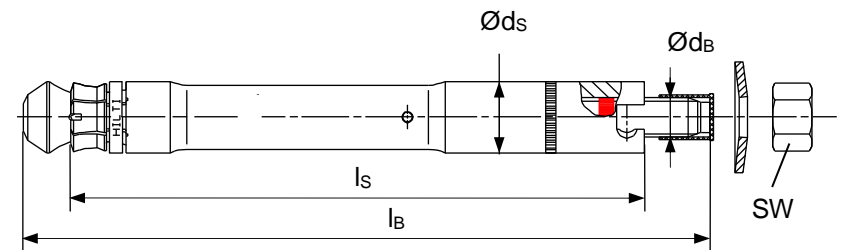

Setting information

Setting details

Anchor size			HDA-P / HDA-PR / HDA-T / HDA-TR							
			M10		M12		M16		M20	
			x100/20	x125/30	x125/50	x190/40	x190/60	x250/50	x250/100	
Length code letter			I	L	N	R	S	V	X	
Nominal drill bit diameter	d_0	[mm]	20	22		30		37		
Cutting diameter of drill bit	$d_{cut,min}$	[mm]	20,10	22,10		30,10		37,15		
	$d_{cut,max}$	[mm]	20,55	22,55		30,55		37,70		
Depth of drill hole	$h_1 \geq$	[mm]	107	133		203		266		
Anchorage depth	h_{ef}	[mm]	100	125		190		250		
Sleeve recess	$h_{s,min}$	[mm]	2	2		2		2		
	$h_{s,max}$	[mm]	6	7		8		8		
Torque moment	T_{inst}	[Nm]	50	80		120		300		
For HDA-P/-PR/-PF										
Clearance hole	d_f	[mm]	12	14		18		22		
Minimum base material thickness	h_{min}	[mm]	180	200		270		350		
Fixture thickness	$t_{fix,min}$	[mm]	0	0		0		0		
	$t_{fix,max}$	[mm]	20	30	50	40	60	50	100	

For HDA-T/-TR/-TF								
Clearance hole	d_f	[mm]	21	23		32		40
Minimum base material thickness	h_{min}	[mm]	200- t_{fix}	230- t_{fix}	250- t_{fix}	310- t_{fix}	330- t_{fix}	400- t_{fix} / 450- t_{fix}
Min. fixture thickness								
Tension load only!	$t_{fix,min}$	[mm]	10	10		15		20 / 50
Shear load without use of centering washer	$t_{fix,min}$	[mm]	15	15		20		25 / 50
Shear load - with use of centering washer	$t_{fix,min}^{b)}$	[mm]	10	10		15		20 / -
Max. fixture thickness	$t_{fix,max}$	[mm]	20	30	50	40	60	50 / 100

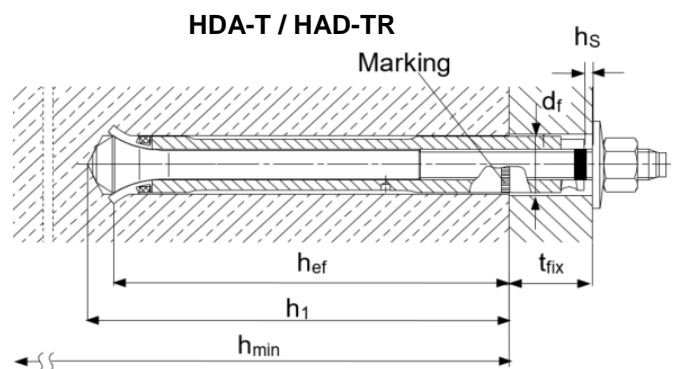
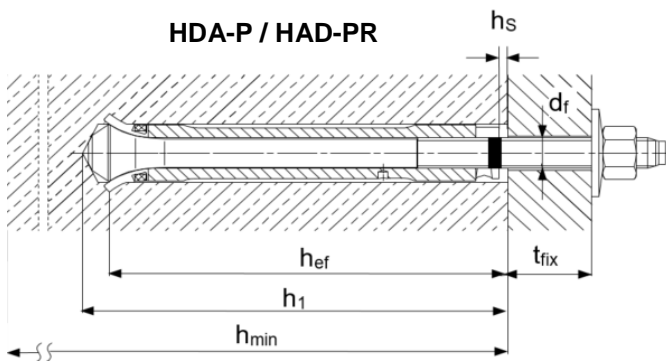

Setting parameters

Anchor size		HDA-P / HDA-PR / HDA-T / HDA-TR							
		M10		M12		M16		M20	
		x100/20	x125/30	x125/50	x190/40	x190/60	x250/50	x250/100	
Minimum spacing	s_{min}	[mm]	100	125		190		250	
Minimum edge distance	c_{min}	[mm]	80	100		150		200	
Critical spacing for splitting failure	$s_{cr,sp}$	[mm]	300	375		570		750	
Critical edge distance for splitting failure	$c_{cr,sp}$	[mm]	150	190		285		375	
Critical spacing for concrete cone failure	$s_{cr,N}$	[mm]	300	375		570		750	
Critical edge distance for concrete cone failure	$c_{cr,N}$	[mm]	150	190		285		375	

For spacing (edge distance) smaller than critical spacing (critical edge distance) the design loads have to be reduced.

Critical spacing and critical edge distance for splitting failure apply only for non-cracked concrete. For cracked concrete only the critical spacing and critical edge distance for concrete cone failure are decisive.

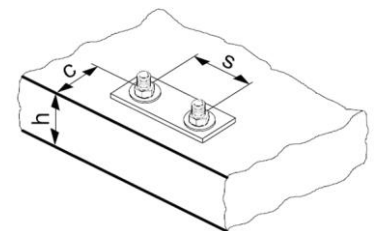

Stop drill bit HDA

The stop drill is required for drilling in order to achieve the correct hole depth.

The setting system (tool and setting tool) is required for transferring the specific energy for the undercutting process.

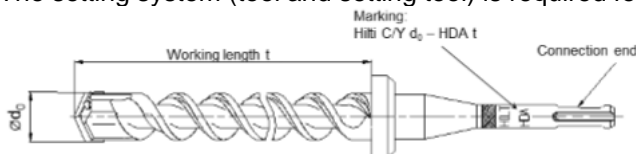

Required stop drill bits for HDA and HDA-R

Anchor	Stop drill bit with TE-C (SDS plus) connection end	Stop drill bit with TE-Y (SDS max) connection end	Nominal working length t [mm]	Drill bit diameter d ₀ [mm]
HDA-P/ PF/ PR M10x100/20	TE-C-HDA-B 20x100	TE-Y-HDA-B 20x100	107	20
HDA-T/ TF/ TR M10x100/20	TE-C-HDA-B 20x120	TE-Y-HDA-B 20x120	127	20
HDA-P/ PF/ PR M12x125/30 HDA-P/ PF/ PR M12x125/50	TE-C HDA-B 22x125	TE-Y HDA-B 22x125	133	22
HDA-T/ TF/ TR M12x125/30	TE-C HDA-B 22x155	TE-Y HDA-B 22x155	163	22
HDA-T/ TF/ TR M12x125/50	TE-C HDA-B 22x175	TE-Y HDA-B 22x175	183	22
HDA-P/ PF/ PR M16 x190/40 HDA-P/ PF/ PR M16 x190/60		TE-Y HDA-B 30x190	203	30
HDA-T/ TF/ TR M16x190/40		TE-Y HDA-B 30x230	243	30
HDA-T/ TF/ TR M16x190/60		TE-Y HDA-B 30x250	263	30
HDA-P M20 x250/50 HDA-P M20 x250/100		TE-Y HDA-B 37x250	266	37
HDA-T M20x250/50		TE-Y HDA-B 37x300	316	37
HDA-T M20x250/100		TE-Y HDA-B 37x350	366	37

Anchor	TE 24 a) TE 25 a)	TE 30-A36	TE 35	TE 40 TE 40 AVR	TE 56 TE 56-ATC	TE 60 TE 60-ATC	TE 70 TE 70-ATC	TE 75	TE 76 TE 76-ATC	TE 80-ATC TE 80-ATC AVR	Setting tool
HDA-P/T M10x100/20	■	■		■	■	■					TE-C-HDA-ST 20 M10
											TE-Y-HDA-ST 20 M10
HDA-P/T M12x125/30 HDA-P/T M12x125/50	■	■		■	■	■					TE-C-HDA-ST 22 M12
											TE-Y-HDA-ST 22 M12
HDA-P/T M16x190/40 HDA-P/T M16x190/60							■	■	■	■	TE-Y-HDA-ST 30 M16
							■		■	■	TE-Y-HDA-ST 37 M20

a) 1st gear

Anchor	TE 24 a) TE 25 a)	TE 30-A36	TE 35	TE 40 TE 40 AVR	TE 56 TE 56-ATC	TE 60 TE 60-ATC	TE 70 TE 70-ATC	TE 75	TE 76 TE 76-ATC	TE 80-ATC TE 80-ATC AVR	Setting tool
HDA-PR/TR M10x100/20	■	■	■	■		■					TE-C-HDA-ST 20 M10
					■	■					TE-Y-HDA-ST 20 M10
HDA-PR/TR M12x125/30 HDA-PR/TR M12x125/50	■	■	■	■		■					TE-C-HDA-ST 22 M12
					■	■					TE-Y-HDA-ST 22 M12
HDA-PR/TR M16x190/40 HDA-PR/TR M16x190/60							■	■	■	■	TE-Y-HDA-ST 30 M16

a) 1st gear

Anchor	TE 24 a) TE 25 a)	TE 30-A36	TE 35	TE 40 TE 40 AVR	TE 56 TE 56-ATC	TE 60 TE 60-ATC	TE 70 TE 70-ATC	TE 75	TE 76 TE 76-ATC	TE 80-ATC TE 80-ATC AVR	Setting tool
HDA-PF/TF M10x100/20		■	■	■		■					TE-C-HDA-ST 20 M10
HDA-PF/TF M12x125/30 HDA-PF/TF M12x125/50		■	■	■		■					TE-C-HDA-ST 22 M12
HDA-PF/TF M16x190/40 HDA-PF/TF M16x190/60							■	■	■	■	TE-Y-HDA-ST 30 M16

 a) 1st gear

Setting instructions

*For detailed information on installation see instruction for use given with the package of the product.

HDA-P / HDA-PR (prepositioning)

- 1. Drilling**
- 2. Cleaning**
- 3. Inserting the anchor by hand**
- 4. Applying hammer drill**
- 5. Applying hammer drill**
- 6. Checking**
- 7. Attaching the fixture**
- 8. Attaching the belonging washer**

HDA-T / HDA-TR / HAD-TF (post-positioning)

1. Drilling

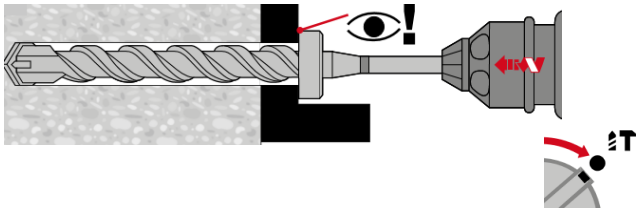

2. Cleaning

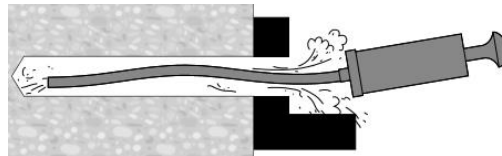

3. Inserting the anchor by hand

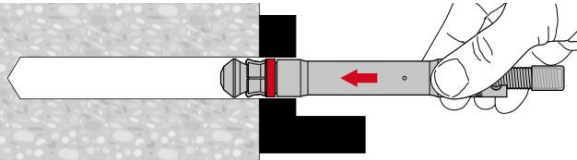

4. Applying hammerdrill

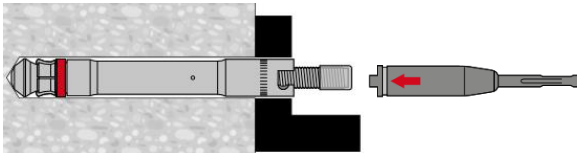

5. Checking

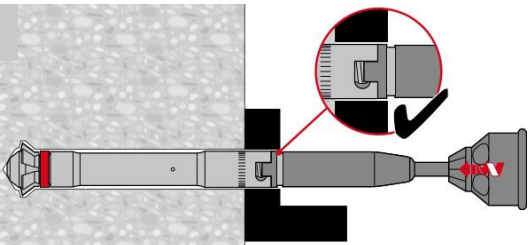

6. Checking

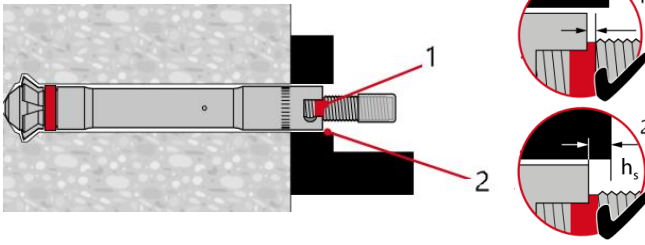

7. Attaching the belonging washer

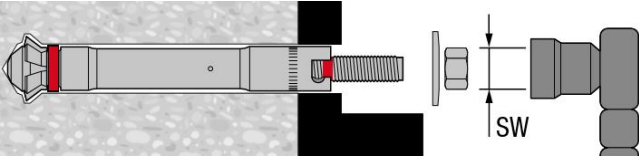

HMU-PF Undercut anchor

Everyday standard undercut anchor for cracked concrete

Chemical anchors

Undercut

Mechanical anchors

Plastic/Light duty metal anchors

Insulation anchors

Anchor version



HMU-PF
(M12-M16)

Benefits

- Reliable mechanical interlock due to consistent high quality self-undercut
- ETA approval for cracked and non-cracked concrete
- Seismic approval ETA C1
- Comes standard with a hot-dip galvanized protective coating against corrosion
- Cost efficient heavy duty anchoring solution for high volume fastenings
- Easy verification of correct setting due to red setting mark
- Optimized and matching system components enable efficient and reliable installation

Base material



Concrete
(non-cracked)



Concrete
(cracked)

Load conditions

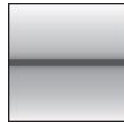

Static/
quasi-static



Seismic
ETA-C1



Fire
resistance

Installation conditions



Hammer
drilled holes

Other information



European
Technical
Assessment



CE
conformity



PROFIS
design
Software

Approvals / certificates

Description	Authority / Laboratory	No. / date of issue
European Technical Assessment ^{a)}	CSTB, Marne-la-Vallée	ETA-14/0069 / 2015-12-24
Shockproof fastenings in civil defence installations	Federal Office for Civil Protection, Bern	BZS D 14-602/2014-10-31

a) All data given in this section according to ETA-14/0069, issue 2015-12-24.

Static resistance

All data in this section applies to:

- Correct setting (See setting instruction)
- No edge distance and spacing influence
- *Steel* failure
- Minimum base material thickness
- Concrete C 20/25, $f_{ck,cube} = 25 \text{ N/mm}^2$

Effective anchorage depth for static

Anchor size		M12	M16	M16
Effective anchorage depth range	h_{ef} [mm]	80	100	125

Characteristic resistance

Anchor size			M12x80	M16x100	M16x125
Non-cracked concrete					
Tension N_{Rk}	HMU-PF	[kN]	36,1	50,5	70,6
Shear V_{Rk}	HMU-PF		33,7	62,8	62,8
Cracked concrete					
Tension N_{Rk}	HMU-PF	[kN]	20	36	50,3
Shear V_{Rk}	HMU-PF		33,7	62,8	62,8

Design resistance

Anchor size			M12x80	M16x100	M16x125
Non-cracked concrete					
Tension N_{Rd}	HMU-PF	[kN]	24,1	33,7	47,1
Shear V_{Rd}	HMU-PF		27,0	50,2	50,2
Cracked concrete					
Tension N_{Rd}	HMU-PF	[kN]	13,3	24,0	33,5
Shear V_{Rd}	HMU-PF		27,0	48,0	50,2

Recommended loads ^{a)}

Anchor size			M12x80	M16x100	M16x125
Non-cracked concrete					
Tension N_{Rec}	HMU-PF	[kN]	17,2	24	33,6
Shear V_{Rec}	HMU-PF		19,3	35,9	19,3
Cracked concrete					
Tension N_{Rec}	HMU-PF	[kN]	9,5	17,1	24,0
Shear V_{Rec}	HMU-PF		19,3	34,3	35,9

a) With overall partial safety factor for action $\gamma = 1,4$. The partial safety factors for action depend on the type of loading and shall be taken from national regulations.

Seismic resistance (for a single anchor)

All data in this section applies to:

- Correct setting (See setting instruction)
- No edge distance and spacing influence
- *Steel* failure
- Minimum base material thickness
- Concrete C 20/25, $f_{ck,cube} = 25 \text{ N/mm}^2$
- $\alpha_{gap} = 1,0$ (using Hilti seismic filling set)

Effective anchorage depth for seismic C1

Anchor size	M12	M16	M16
Effective anchorage depth range h_{ef} [mm]	80	100	125

Characteristic resistance in case of seismic performance category C1

Anchor size	M12x80	M16x100	M16x125
Tension $N_{Rk,seis}$ HMU-PF [kN]	17,3	30,6	42,8
Shear $V_{Rk,seis}$ HMU-PF [kN]	33,7	61,2	62,8

Design resistance in case of seismic category C1

Anchor size	M12x80	M16x100	M16x125
Tension $N_{Rd,seis}$ HMU-PF [kN]	11,5	20,4	28,5
Shear $V_{Rd,seis}$ HMU-PF [kN]	27,0	40,8	50,2

Fire resistance

Fire resistance data according to ETA-14/0069

All data in this section applies to:

- Correct setting (See setting instruction)
- No edge distance and spacing influence
- *Steel* failure
- Minimum base material thickness
- Concrete C 20/25, $f_{ck,cube} = 25 \text{ N/mm}^2$

Recommended tension and shear resistance in cracked and non-cracked concrete

Anchor size	M12X80	M16X100	M16X125
HMU-PF	R30 $F_{Rk,fi}$ [kN]	1,7	3,1
	R120 $F_{Rk,fi}$ [kN]	0,8	1,6

For more information about different failure modes and fire resistance times please see the full ETA-14/0069 report.

Materials

Mechanical properties

Anchor size			M12x80	M16x100	M16x125
Nominal tensile strength	f_{uk}	[N/mm ²]	800	800	800
Yield strength	f_{yk}	[N/mm ²]	640	640	640
Stressed cross-section, thread	A_s	[mm ²]	84,3	157	157
Moment of resistance	W	[mm ³]	109	278	278
Char. bending resistance	$M^0_{Rk,s}$	[Nm]	105	266	266

Material quality

Part	Material
Threaded bolt with cone	Carbon steel strength 8.8, hot dip galvanized to min. 50 μ m
Sleeve	Carbon steel, hot dip galvanized min. 50 μ m
Hexagon nut	Steel grade 8, hot dip galvanized min. 50 μ m
Washer	According to DIN 125-1, 140 HV, hot dip galvanized min. 50 μ m

Letter code for anchor length

Anchor size	HMU-PF M12	M12x80/20	M12x80/35	M12x80/65
Letter code		H	I	K
Anchor size	HMU-PF M16	M16x100/30	M16x100/60	M16x125/60
Letter code		K	M	O

Anchor dimension

Anchor size		M12x80	M16x100	M16x125
Total length of bolt L_B	min	133	167	222
	max	176	197	239
Diameter of sleeve	d_s	17,5	21,6	21,6
Length of sleeve	l_s	80,6	100	125

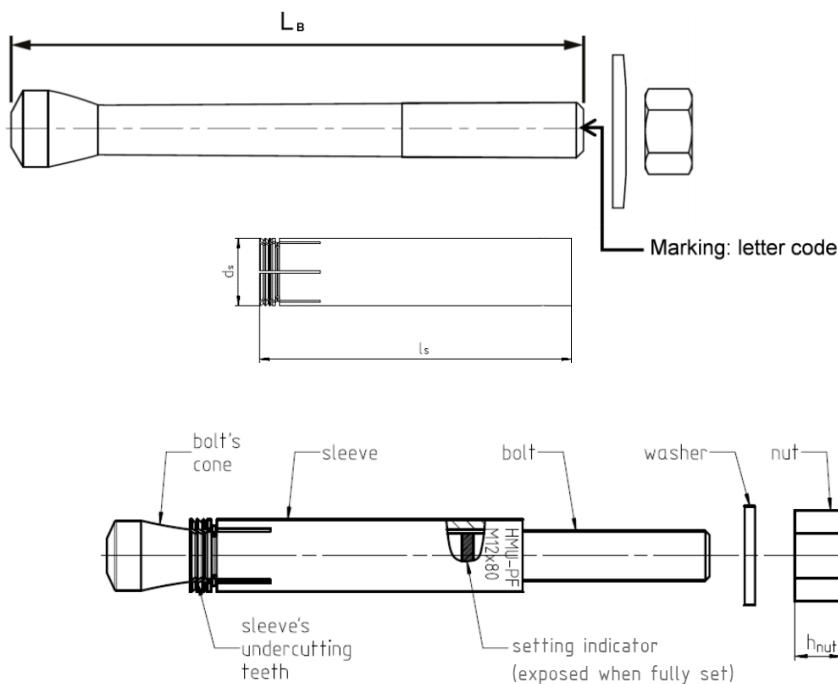

Setting information

Setting details of HMU-PF

Anchor size			M12x80	M16x100	M16x125
Effective anchorage depth	h_{ef}	[mm]	80	100	125
Nominal Diameter of drill bit	d_0	[mm]	18	23	
Cutting diameter of drill bit ¹⁾	$d_{cut} \leq$	[mm]	18,5	23,0	
Depth of drill hole	$h_1 =$	[mm]	92	115	140
Diameter of clearance hole in the fixture	$d_f \leq$	[mm]	14	18	
Thickness of fixture	t_{fix}	min.	2	0 ²⁾	0 ²⁾
		max	65	60	75
Torque moment	T_{inst}	[Nm]	45	120	
Width across nut flats	SW	[mm]	19	24	

1) Use special stop drill bit TE-C-HMU-B only.

2) When thickness of attachment is less than 3mm, big washer acc. to DIN1052 standard needs to be used.

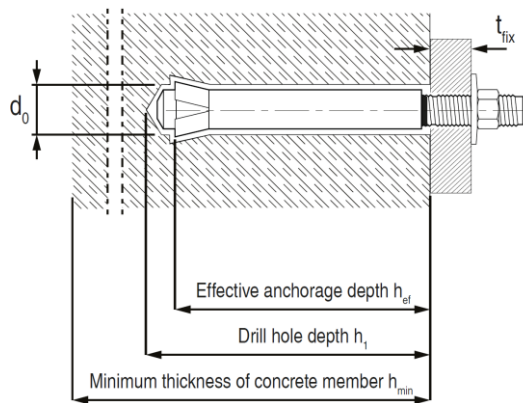

Installation equipment

Anchor size	M12x80	M16x100	M16x125
Rotary hammer	TE 40 / TE 30-A36		
Stop drill bit	TE-C-HMU-B M12x80	TE-C-HMU-B M16x100 TE-Y-HMU-B M16x100	TE-C-HMU-B M16x125 TE-Y-HMU-B M16x125
Setting tool	TE-C-HMU-ST-M12 / TE-Y-HMU-ST-M16		
Insert connections	TE-C (SDS Plus)	TE-C (SDS Plus) TE-Y (SDS Max)	
Other tools	Blow-out bulb		

Setting parameters

Anchor size			M12	M16	M16
Effective anchorage depth	h_{ef}	[mm]	80	100	125
Minimum base material thickness	$h_{min} \geq$	[mm]	160	200	250
Minimum spacing	$s_{min} \geq$	[mm]	90	100	100
Minimum edge distance	$c_{min} \geq$	[mm]	90	100	100
Critical spacing for splitting failure	$s_{cr,sp}$	[mm]	300	300	375
Critical edge distance for splitting failure	$c_{cr,sp}$	[mm]	150	160	200
Critical spacing for concrete cone failure	$s_{cr,N}$	[mm]	240	300	375
Critical edge distance for concrete cone failure	$c_{cr,N}$	[mm]	120	150	188

In case of smaller edge distance and spacing than $c_{cr,sp}$, $s_{cr,sp}$, $c_{cr,N}$ and $s_{cr,N}$ the load values shall be reduced according ETAG 001, Annex C.

Critical spacing and critical edge distance for splitting failure apply only for non-cracked concrete.

For cracked concrete only the critical spacing and critical edge distance for concrete cone failure are decisive.

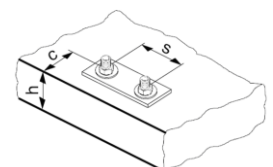

Setting instruction

*For detailed information on installation see instruction for use given with the package of the product.

Setting instruction for HMU-PF	
<p>1. Drilling</p>	<p>2. Cleaning</p>
<p>3. Inserting the anchor by hand</p>	<p>4. Applying hammer drill</p>
<p>5. Applying hammer drill</p>	<p>6. Checking</p>
<p>7. Attaching the fixture</p>	<p>8. Attaching the belonging washer</p>

HSC Undercut anchors

Ultimate-performance undercut anchor for shallow embedment depth

Chemical anchors

Undercut

Mechanical anchors

Plastic/Light duty metal anchors

Insulation anchors

Anchor version



HSC-A
HSC-AR
(M8-M12)



HSC-I
HSC-IR
(M6-M12)

Benefits

- The perfect solution for small edge and space distance
- Suitable for thin concrete blocks due to low embedment depth
- Seismic design with ETA C2 approval
- Suitable for cracked concrete
- Self-cutting undercut anchor
- Available as bolt version for through applications
- Stainless steel available for external applications

Base material



Concrete (non-cracked)

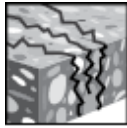

Concrete (cracked)

Load conditions

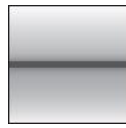

Static/
quasi-static



Shock



Fire
resistance



Seismic
ETA-C2

Installation conditions

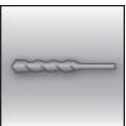

Hammer
drilled holes

Other information



European
Technical
Assessment



CE
conformity



PROFIS
design
Software



Corrosion
resistance

Approvals / certificates

Description	Authority / Laboratory	No. / date of issue
European Technical Assessment ^{a)}	CSTB, Marne-la-Vallée	ETA-02/0027 / 2018-07-04
Fire test report ^{a)}	CSTB, Marne-la-Vallée	ETA-02/0027 / 2018-07-04
Shockproof fastenings in civil defence installations	Federal Office for Civil Protection, Bern	BZS D 06-601 / 2006-07-10

a) All data given in this section according to ETA-02/0027 issue 2018-07-04.

Static resistance

All data in this section applies to:

- Correct setting (See setting instruction)
- No edge distance and spacing influence
- *Steel* failure
- Minimum base material thickness
- Concrete C20/25, $f_{ck,cube} = 25 \text{ N/mm}^2$

HSC-A (R)

Effective anchorage depth of HSC-A (R)

Anchor size		M8	M8	M10	M12
Effective anchorage depth range	h_{ef} [mm]	40	50	40	60

Characteristic resistance of HSC-A (R)

Anchor size			M8 x 40	M8 x 50	M10 x 40	M12 x 60
Non-cracked concrete						
Tension N_{Rk}	HSC-A, HSC-AR	[kN]	12,8	17,8	12,8	23,4
Shear V_{Rk}	HSC-A	[kN]	14,6	14,6	23,2	33,7
	HSC-AR		12,8	12,8	20,3	29,5
Cracked concrete						
Tension N_{Rk}	HSC-A, HSC-AR	[kN]	9,1	12,7	9,1	16,7
Shear V_{Rk}	HSC-A	[kN]	14,6	14,6	18,2	33,5
	HSC-AR		12,8	12,8	18,2	29,5

Design resistance of HSC-A (R)

Anchor size			M8 x 40	M8 x 50	M10 x 40	M12 x 60
Non-cracked concrete						
Tension N_{Rd}	HSC-A, HSC-AR	[kN]	8,5	11,9	8,5	15,6
Shear V_{Rd}	HSC-A	[kN]	11,7	11,7	17,0	27,0
	HSC-AR		8,2	8,2	13,0	18,9
Cracked concrete						
Tension N_{Rd}	HSC-A, HSC-AR	[kN]	6,1	8,5	6,1	11,2
Shear V_{Rd}	HSC-A	[kN]	11,7	11,7	12,1	22,3
	HSC-AR		8,2	8,2	12,1	18,9

Recommended loads ^{a)} of HSC-A (R)

Anchor size			M8 x 40	M8 x 50	M10 x 40	M12 x 60
Non-cracked concrete						
Tension N_{Rec}	HSC-A, HSC-AR	[kN]	6,1	8,5	6,1	11,2
Shear V_{Rec}	HSC-A	[kN]	8,3	8,3	12,1	19,3
	HSC-AR		5,9	5,9	9,3	13,5
Cracked concrete						
Tension N_{Rec}	HSC-A, HSC-AR	[kN]	4,3	6,1	4,3	8,0
Shear V_{Rec}	HSC-A	[kN]	8,3	8,3	8,7	15,9
	HSC-AR		5,9	5,9	8,7	13,5

a) With overall partial safety factor for action $\gamma = 1,4$. The partial safety factors for action depend on the type of loading and shall be taken from national regulations.

HSC-I (R)

Effective anchorage depth of HSC-I (R)

Anchor size	M6	M8	M10	M10	M12
Eff. anchorage depth range h_{ef} [mm]	40	40	50	60	60

Characteristic resistance of HSC-I (R)

Anchor size		M6 x 40	M8 x 40	M10 x 50	M10 x 60	M12 x 60
Non-cracked concrete						
Tension N_{Rk}	HSC-I, HSC-IR [kN]	12,8	12,8	17,8	23,4	23,4
Shear V_{Rk}	HSC-I [kN]	8,0	12,2	15,2	15,2	18,2
	HSC-IR [kN]	7,0	10,7	13,3	13,3	16,0
Cracked concrete						
Tension N_{Rk}	HSC-I, HSC-IR [kN]	9,1	9,1	12,7	12,7	16,7
Shear V_{Rk}	HSC-I [kN]	8,0	12,2	15,2	15,2	18,2
	HSC-IR [kN]	7,0	10,7	13,3	13,3	16,0

Design resistance of HSC-I (R)

Anchor size		M6 x 40	M8 x 40	M10 x 50	M10 x 60	M12 x 60
Non-cracked concrete						
Tension N_{Rd}	HSC-I [kN]	8,5	8,5	11,9	15,6	15,6
	HSC-IR [kN]	7,5	8,5	11,9	14,2	15,6
Shear V_{Rd}	HSC-I [kN]	6,4	9,8	12,2	12,2	14,6
	HSC-IR [kN]	4,5	6,9	8,5	8,5	10,3
Cracked concrete						
Tension N_{Rd}	HSC-I, HSC-IR [kN]	6,1	6,1	8,5	11,2	11,2
Shear V_{Rd}	HSC-I [kN]	6,4	9,8	12,2	12,2	14,6
	HSC-IR [kN]	4,5	6,9	8,5	8,5	10,3

Recommended loads ^{a)} of HSC-I (R)

Anchor size		M6 x 40	M8 x 40	M10 x 50	M10 x 60	M12 x 60
Non-cracked concrete						
Tension N_{Rec}	HSC-I [kN]	6,1	6,1	8,5	11,2	11,2
	HSC-IR [kN]	5,4	6,1	8,5	10,1	11,2
Shear V_{Rec}	HSC-I [kN]	4,6	7,0	8,7	8,7	10,4
	HSC-IR [kN]	3,2	4,9	6,1	6,1	7,3
Cracked concrete						
Tension N_{Rec}	HSC-I, HSC-IR [kN]	4,3	4,3	6,1	8,0	8,0
Shear V_{Rec}	HSC-I [kN]	4,6	7,0	8,7	8,7	10,4
	HSC-IR [kN]	3,2	4,9	6,1	6,1	7,3

a) With overall partial safety factor for action $\gamma = 1,4$. The partial safety factors for action depend on the type of loading and shall be taken from national regulations.

Seismic loading (for a single anchor)

All data in this section applies to:

- Correct setting (See setting instruction)
- No edge distance and spacing influence
- *Steel* failure
- Cracked concrete
- Minimum base material thickness
- Concrete C 20/25, $f_{ck,cube} = 25 \text{ N/mm}^2$
- $\alpha_{gap} = 1,0$ (using Hilti seismic filling set)

Characteristic resistance for HSC-A in case of seismic performance C2

Anchor size		M8 x 40	M8 x 50	M10 x 40
Tension $N_{Rk, seis}$	HSC-A [kN]	2,4	2,4	4,5
Shear $V_{Rk, seis}$	HSC-A [kN]	12,4	12,4	15,5

Design resistance for HSC-A in case of seismic performance C2

Anchor size		M8 x 40	M8 x 50	M10 x 40
Tension $N_{Rd, seis}$	HSC-A [kN]	1,6	1,6	3,0
Shear $V_{Rd, seis}$	HSC-A [kN]	9,9	9,9	10,3

Recommended resistance for HSC-A in case of seismic performance C2

Anchor size		M8 x 40	M8 x 50	M10 x 40
Tension $N_{Rd, seis}$	HSC-A [kN]	1,1	1,1	2,1
Shear $V_{Rd, seis}$	HSC-A [kN]	7,1	7,1	7,4

Fire resistance

All data in this section applies to:

- Correct setting (See setting instruction)
- No edge distance and spacing influence
- *Steel* failure
- Minimum base material thickness
- Concrete C 20/25, $f_{ck,cube} = 25 \text{ N/mm}^2$

HSC-A (R)

Effective anchorage depth of HSC-A (R)

Anchor size	M8	M8	M10	M12
Eff. anchorage depth range h_{ef} [mm]	40	50	40	60

Characteristic/design¹ resistance in uncracked concrete and cracked concrete

Anchor size		M8 x 40	M8 x 50	M10 x 40	M12 x 60
Fire Exposure R30					
Tension $N_{Rk,fi}$	HSC-A [kN]	0,4	0,4	0,9	1,7
	HSC-AR	0,7	0,7	1,5	2,5
Shear $V_{Rk,fi}$	HSC-A [kN]	0,4	0,4	0,9	1,7
	HSC-AR	0,7	0,7	1,5	2,5
Fire Exposure R120					
Tension $N_{Rk,fi}$	HSC-A [kN]	0,2	0,2	0,5	0,8
	HSC-AR	0,4	0,4	0,8	1,3
Shear $V_{Rk,fi}$	HSC-A [kN]	0,2	0,2	0,5	0,8
	HSC-AR	0,4	0,4	0,8	1,3

1) The safety factor is $\gamma=1.0$ for all load cases

HSC-I (R)

Effective anchorage depth of HSC-I (R)

Anchor size	M6	M8	M10	M10	M12
Eff. anchorage depth range h_{ef} [mm]	40	40	50	60	60

Characteristic/design¹ resistance in uncracked concrete and cracked concrete

Anchor size		M6 x 40	M8 x 40	M10 x 50	M10 x 60	M12 x 60
Fire Exposure R30						
Tension $N_{Rk,fi}$	HSC-I [kN]	0,2	0,4	0,9	0,4	1,7
	HSC-IR	0,2	0,7	1,5	0,7	2,5
Shear $V_{Rk,fi}$	HSC-I [kN]	0,2	0,4	0,9	0,4	1,7
	HSC-IR	0,2	0,7	1,5	0,7	2,5
Fire Exposure R120						
Tension $N_{Rk,fi}$	HSC-I [kN]	0,1	0,2	0,5	0,2	0,8
	HSC-IR	0,1	0,4	0,8	0,4	1,3
Shear $V_{Rk,fi}$	HSC-I [kN]	0,1	0,2	0,5	0,2	0,8
	HSC-IR	0,1	0,4	0,8	0,4	1,3

1) The safety factor is $\gamma=1.0$ for all load cases

Materials

Mechanical properties for HSC-A (R)

Anchor size			M8 x 40	M8 x 50	M10 x 40	M12 x 60
Nominal tensile strength	f_{uk}	HSC-A	800	800	800	800
		HSC-AR	700	700	700	700
Yield strength	f_{yk}	HSC-A	640	640	640	640
		HSC-AR	450	450	450	450
Stressed cross-section for bolt version	$A_{s,A}$	HSC-A	36,6	36,6	58,0	84,3
		HSC-AR				
Moment of resistance	W	HSC-A	31,2	31,2	62,3	109,2
		HSC-AR				
Design bending resistance Without sleeve	$M_{Rd,s}$	HSC-A	24	24	48	84
		HSC-AR	16,7	16,7	33,3	59,0

Mechanical properties for HSC-I (R)

Anchor size			M6 x 40	M8 x 40	M10 x 50	M10 x 60	M12 x 60
Nominal tensile strength	f_{uk}	HSC-I	800	800	800	800	800
		HSC-IR	700	700	700	700	700
Yield strength	f_{yk}	HSC-I	640	640	640	640	640
		HSC-IR	355	355	350	350	340
Stressed cross-section for internal thread version	$A_{s,I}$	HSC-I	22,0	28,3	34,6	34,6	40,8
		HSC-IR					
Stressed cross-section for external thread version	$A_{s,A}$	HSC-I	20,1	36,6	58,0	58,0	84,3
		HSC-IR					
Moment of resistance	W	HSC-I	12,7	31,2	62,3	62,3	109,2
		HSC-IR					
Design bending resistance without sleeve	$M_{Rd,s}$	HSC-I	9,6	24	48	48	84
		HSC-IR	7,1	16,7	33,3	33,3	59,0

Material quality

Part	Material	
Metal parts made of zinc coated steel		
HSC-A HSC-I	Cone bolt with internal thread	Carbon steel strength 8.8, galvanized to min. 5 μ m
	Cone bolt with internal thread	
	Expansion sleeve	Galvanized to min. 5 μ m
	Washer	
	Hexagon nut	
HSC-AR / HSC-IR Stainless steel		
HSC-AR HSC-IR	Cone bolt with internal thread	A4-70, Stainless steel 1.4401, 1.4571 EN 10088-1:2014
	Cone bolt with internal thread	
	Expansion sleeve	Stainless steel 1.4401, 1.4571 EN 10088-1:2014
	Washer	
	Hexagon nut	

Anchor dimension of HSC-A (R)

Anchor size		M8 x 40	M8 x 50	M10 x 40	M12 x 60
Diameter of cone bolt	b [mm]	13,5	13,5	15,5	17,5
Length of expansion sleeve	l _s [mm]	40,8	50,8	40,8	60,8
Diameter of expansion sleeve	d [mm]	13,5	13,5	15,5	17,5
Diameter of washer	e [mm]	16	16	20	24

Anchor dimension of HSC-I (R)

Anchor size		M6 x 40	M8 x 40	M10 x 50	M10 x 60	M12 x 60
Length of cone bolt	l _b [mm]	43,8	43,8	54,8	64,8	64,8
Diameter of cone bolt	b [mm]	13,5	13,5	15,5	13,5	17,5
Length of expansion sleeve	l _s [mm]	40,8	40,8	50,8	50,8	60,8
Diameter of expansion sleeve	d [mm]	13,5	15,5	17,5	17,5	19,5

Setting information

Setting details of HSC-A (R)

Anchor size		M8 x 40	M8 x 50	M10 x 40	M12 x 60
Effective anchorage depth	h _{ef} [mm]	40	50	40	60
Nominal Diameter of drill bit	d ₀ [mm]	14	14	16	18
Cutting diameter of drill bit ¹⁾	d _{cut} [mm]	14,5	14,5	16,5	18,5
Maximum fastening thickness	t _{fix} [mm]	15	15	20	20
Depth of drill hole	h ₁ [mm]	46	56	46,5	68
Diameter of clearance hole in the fixture	d _f ≤ [mm]	9	9	12	14
Torque moment	T _{inst} [Nm]	10	10	20	30
Width across nut flats	SW [mm]	13	13	17	19

Setting details of HSC-I (R)

Anchor size		M6 x 40	M8 x 40	M10 x 50	M10 x 60	M12 x 60
Effective anchorage depth	h _{ef} [mm]	40	40	50	60	60
Nominal Diameter of drill bit	d ₀ [mm]	14	16	18	18	20
Cutting diameter of drill bit ¹⁾	d _{cut} ≤ [mm]	14,5	16,5	18,5	18,5	20,5
Depth of drill hole	h ₁ = [mm]	46	46,5	56	68	68,5
Diameter of clearance hole in the fixture	d _f ≤ [mm]	7	9	12	12	14
Torque moment	T _{inst} [Nm]	10	10	20	30	30
Width across nut flats	SW [mm]	10	13	17	17	19
Screwing depth	min s mm	6	8	10	10	12
	max s mm	16	22	28	28	30

Installation equipment for HSC-A (R)

Anchor size		M8 x 40	M8 x 50	M10 x 40	M12 x 60
Rotary hammer for setting		TE 7-C; TE 7-A; TE 16; TE 16-C; TE 16-M; TE 25; TE 30; TE 35		TE 7-C; TE 7-A; TE 25; TE 35	TE 16; TE 16-C; TE 16-M; TE 25; TE 30; TE 35; TE 40; TE 40-AVR
Stepped drill bit	TE-C-HSC-B	14x40	14x50	16x40	18x60
Setting tool	TE-C-HSC-MW	14	14	16	18

Installation equipment for HSC-A (R)

Anchor size		M8 x 40	M8 x 50	M10 x 40	M12 x 60
Rotary hammer for setting		TE 7-C; TE 7-A; TE 16; TE 16-C; TE 16-M; TE 25; TE 30; TE 35		TE 7-C; TE 7-A; TE 25; TE 35	TE 16; TE 16-C; TE 16-M; TE 25; TE 30; TE 35; TE 40; TE 40-AVR
Stepped drill bit	TE-C-HSC-B	14x40	14x50	16x40	18x60
Setting tool	TE-C-HSC-MW	14	14	16	18

Installation equipment for HSC-I (R)

Anchor size		M6 x 40	M8 x 40	M10 x 50	M10 x 60	M12 x 60
Rotary hammer for setting		TE 7-C; TE 7-A; TE 16; TE 16-C; TE 16-M; TE 25; TE 30; TE 35				TE 16; TE 16-C; TE 16-M; TE 25; TE 30; TE 35; TE 40; TE 40-AVR
Stepped drill bit	TE-C-HSC-B	14x40	16x40	18x50	18x60	20x60
Setting tool	TE-C-HSC-MW	14	16	18	18	20
Insert tool	TE-C-HSC-EW	14	16	18	18	20

Setting parameters for HSC-A (R)

Anchor size		M8 x 40	M8 x 50	M10 x 40	M12 x 60
Effective anchorage depth	h_{ef} [mm]	40	40	50	60
Minimum base material thickness	$h_{min} \geq$ [mm]	100	100	100	130
Minimum spacing	$s_{min} \geq$ [mm]	40	40	50	60
Minimum edge distance	$c_{min} \geq$ [mm]	40	40	50	60
Critical spacing for splitting failure	$s_{cr,sp}$ [mm]	130	120	170	180
Critical edge distance for splitting failure	$c_{cr,sp}$ [mm]	65	60	85	90
Critical spacing for concrete cone failure	$s_{cr,N}$ [mm]	120	120	150	180
Critical edge distance for concrete cone failure	$c_{cr,N}$ [mm]	60	60	75	90

Setting parameters for HSC-I (R)

Anchor size		M6 x 40	M8 x 40	M10 x 50	M10 x 60	M12 x 60
Effective anchorage depth	h_{ef} [mm]	40	40	50	60	60
Minimum base material thickness	$h_{min} \geq$ [mm]	100	100	100	100	130
Minimum spacing	$s_{min} \geq$ [mm]	40	40	40	50	60
Minimum edge distance	$c_{min} \geq$ [mm]	40	40	50	60	60
Critical spacing for splitting failure	$s_{cr,sp}$ [mm]	130	120	170	180	180
Critical edge distance for splitting failure	$c_{cr,sp}$ [mm]	65	60	85	90	90
Critical spacing for concrete cone failure	$s_{cr,N}$ [mm]	120	120	150	180	180
Critical edge distance for concrete cone failure	$c_{cr,N}$ [mm]	60	60	75	90	90

In case of smaller edge distance and spacing than $c_{cr,sp}$, $s_{cr,sp}$, $c_{cr,N}$ and $s_{cr,N}$ the load values shall be reduced according ETAG 001, Annex C

Critical spacing and critical edge distance for splitting failure apply only for non-cracked concrete.

For cracked concrete only the critical spacing and critical edge distance for concrete cone failure are decisive.

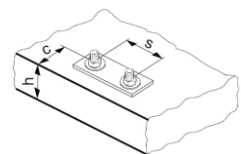

Setting instruction

*For detailed information on installation see instruction for use given with the package of the product.

Setting instruction for HSC-A (R)

1. Drilling

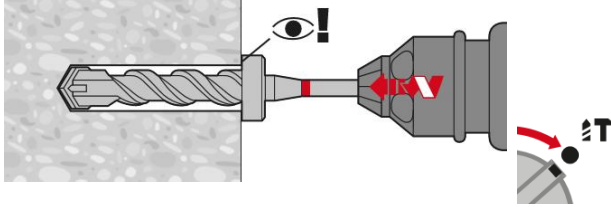

2. Cleaning

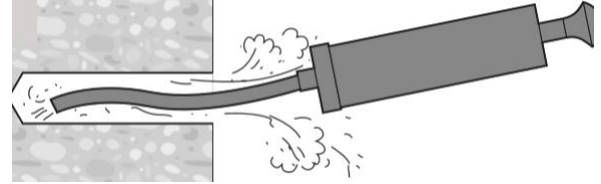

3. Inserting the anchor by hand

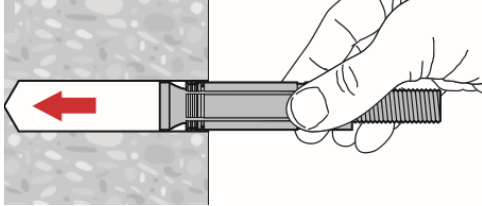

4. Applying hammer drill

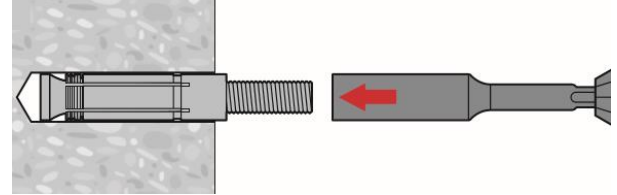

5. Applying hammer drill

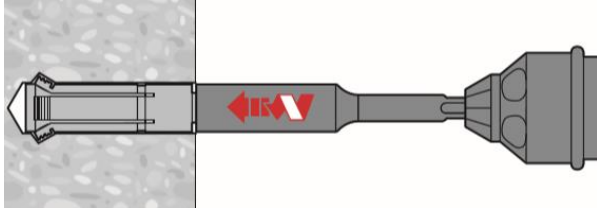

6. Checking

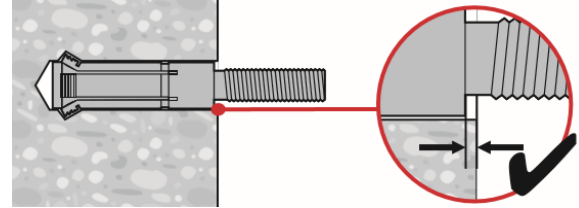

7. Attaching the fixture

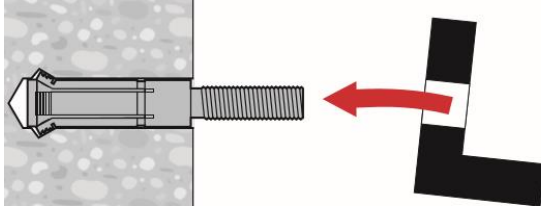

8. Attaching the belonging washer

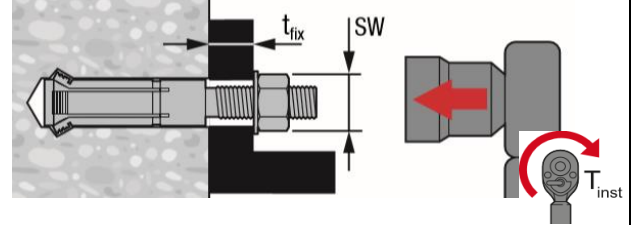

Setting instruction for HSC-I (R)

1. Drilling

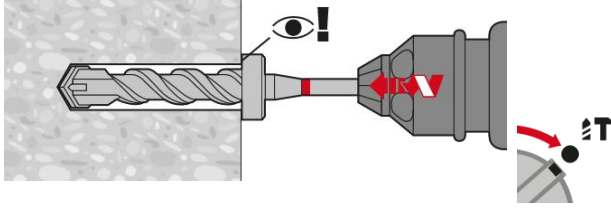

2. Cleaning

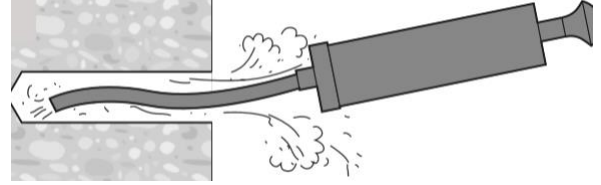

3. Inserting the anchor by hand

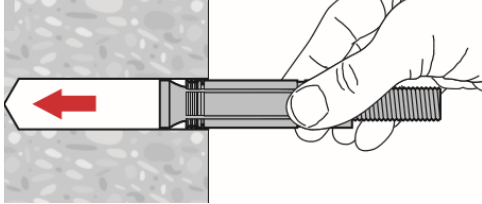

4. Inserting the tool HSC-EW14

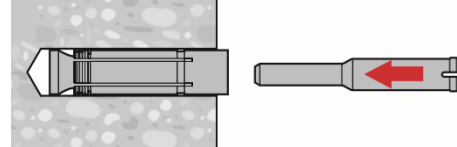

5. Applying hammer drill

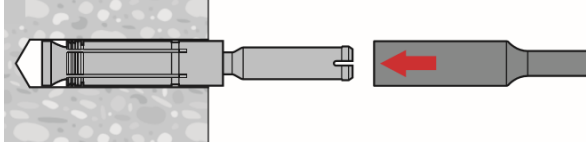

6. Applying hammer drill



7. Applying hammer drill

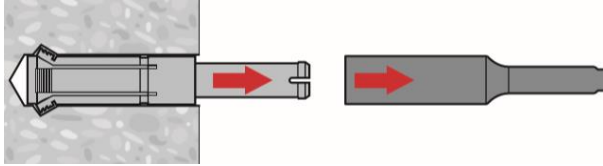

8. Checking

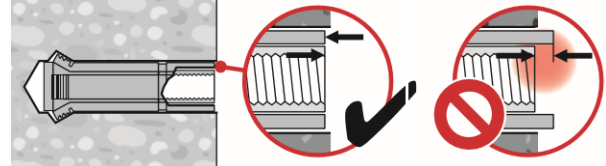

9. Attaching the fixture



10. Attaching the belonging washer

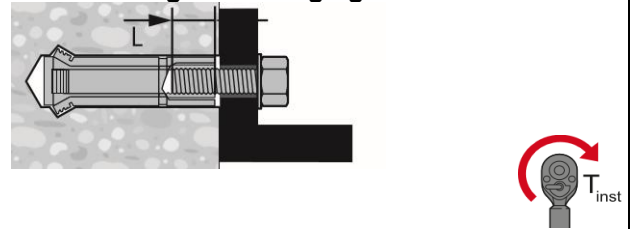

11.

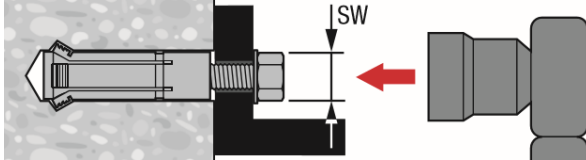

HSL-3 / HSL-3-R expansion anchor

Ultimate-performance heavy-duty expansion anchor

Anchor versions

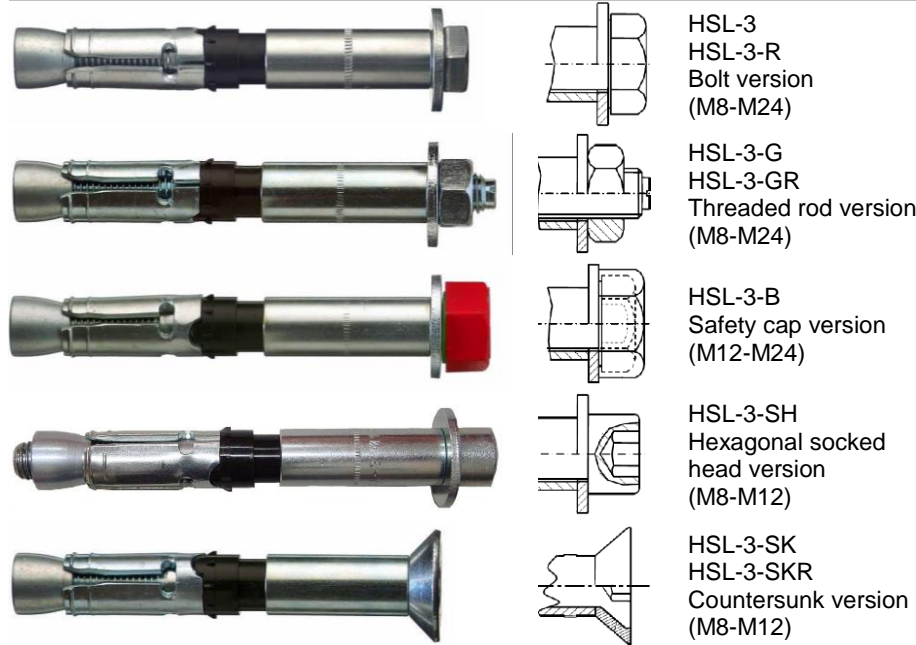

Benefits

- Suitable for cracked concrete C20/25 to C50/60
- Suitable for all dynamic loads: seismic C1 and C2 ^{a)}, shock and fatigue
- Can be installed with hammer or diamond drilling for same performance
- Top shear performance due to high strength expansion and shear sleeves
- Automatic torque control with HSL-3-B
- Length can be customized to a specific project need
- Easily removable for temporary fastening or retrofit

a) Condition valid only for HSL-3 carbon steel version

Base material

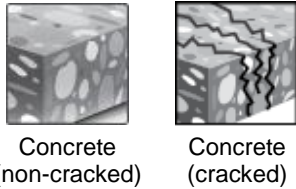

Concrete (non-cracked) Concrete (cracked)

Load conditions

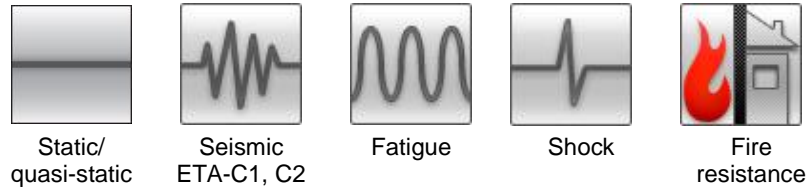

Static/quasi-static Seismic ETA-C1, C2 Fatigue Shock Fire resistance

Installation conditions

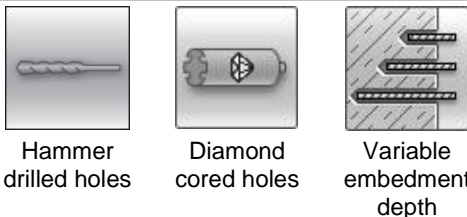

Hammer drilled holes Diamond cored holes Variable embedment depth

Other information

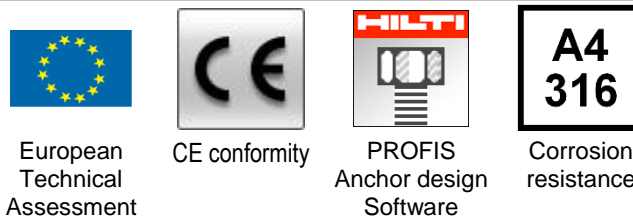

European Technical Assessment CE conformity PROFIS Anchor design Software Corrosion resistance

Approvals/certificates

Description	Authority / Laboratory	No. / Date of issue
European technical Assessment ^{a)}	CSTB, Marne-la-Vallée	ETA-02/0042 / 2017-11-22
Fire test report	CSTB, Marne-la-Vallée	ETA-02/0042 / 2017-11-22
ICC-ES report incl. seismic ^{b)c)}	ICC evaluation service	ESR 1545 / 2017-01
Shock approval ^{c)}	Civil Protection of Switzerland	BZS D 08-601
Fire performance ^{c)}	Exova Warringtonfire	WF 327804/A / 2013-07-10
ACI 349-01 nuclear suitability ^{c)}	Wollmershauser consulting	WC 11-02 / 2011-09

a) All data given in this section according to ETA-02/0042, issue 2017-07-20.
 b) For more details on Technical Data according to ICC please consult the relevant HNA FTM.
 c) Certificate valid only for HSL-3 / HSL-3-G / HSL-3-B / HSL-3-SK / HSL-3-SH

Static and quasi-static resistance (for a single anchor)

All data in this section applies to:

- Correct setting (See setting instruction)
- No edge distance and spacing influence
- *Steel* failure
- Minimum base material thickness
- Concrete C 20/25, $f_{ck,cube}=25$ N/mm²
- Values for HSL-3-R, HSL-3-SKR and HSL-3-GR only applicable for hammer drilling.

Effective anchorage depth ^{a)}

Anchor size		M8			M10			M12		
Eff. Anchorage depth	h_{ef} [mm]	$h_{ef,1}^{b)}$	$h_{ef,2}$	$h_{ef,3}$	$h_{ef,1}^{b)}$	$h_{ef,2}$	$h_{ef,3}$	$h_{ef,1}^{b)}$	$h_{ef,2}$	$h_{ef,3}$
		60	80	100	70	90	110	80	105	130
Anchor size		M16			M20			M24		
Eff. Anchorage depth	h_{ef} [mm]	$h_{ef,1}$	$h_{ef,2}$	$h_{ef,3}$	$h_{ef,1}$	$h_{ef,2}$	$h_{ef,3}$	$h_{ef,1}$	$h_{ef,2}$	$h_{ef,3}$
		100	125	150	125	155	185	150	180	210

a) HSL-3-SH, HSL-3-SK and HSL-3-SKR only available in sizes M8-M12

b) HSL-3-SH, HSL-3-SK and HSL-3-SKR can only be set in position 1.

Characteristic resistance

Anchor size		M8			M10			M12			
Non-cracked concrete											
Tension N_{Rk}	HSL-3 / HSL-3-B HSL-3-G HSL-3-SH / HSL-3-SK ^{a)}	[kN]	23,5	29,3	29,3	29,6	43,1	46,6	36,1	54,3	67,4
	HSL-3-R / HSL-3-SKR ^{a)} HSL-3-GR	[kN]	20,0	20,0	20,0	29,6	40,6	40,6	36,1	54,3	59,0
Shear V_{Rk}	HSL-3 / HSL-3-B	[kN]	31,1	31,1	31,1	59,2	60,5	60,5	72,3	89,6	89,6
	HSL-3-G	[kN]	26,1	26,1	26,1	41,8	41,8	41,8	59,3	59,3	59,3
	HSL-3-SH / HSL-3-SK ^{a)}	[kN]	31,1	-	-	59,2	-	-	72,3	-	-
	HSL-3-R, HSL-3-SKR ^{a)}	[kN]	44,4	44,4	44,4	59,2	62,7	62,7	72,3	81,4	81,4
	HSL-3-GR	[kN]	40,3	40,3	40,3	58,9	58,9	58,9	72,3	78,7	78,7
Cracked concrete											
Tension N_{Rk}	HSL-3 / HSL-3-B HSL-3-G HSL-3-SH / HSL-3-SK ^{a)}	[kN]	12,0	12,0	12,0	16,0	16,0	16,0	25,8	24,0	24,0
	HSL-3-R / HSL-3-SKR ^{a)} HSL-3-GR	[kN]	12,0	12,0	12,0	16,0	16,0	16,0	25,8	24,0	24,0
Shear V_{Rk}	HSL-3 / HSL-3-B	[kN]	30,1	31,1	31,1	42,2	60,5	60,5	51,5	77,5	89,6
	HSL-3-G	[kN]	26,1	26,1	26,1	41,8	41,8	41,8	51,5	59,3	59,3
	HSL-3-SH / HSL-3-SK ^{a)}	[kN]	30,1	-	-	42,2	-	-	51,5	-	-
	HSL-3-R, HSL-3-SKR ^{a)}	[kN]	33,5	44,4	44,4	42,2	61,5	62,7	51,5	77,5	81,4
	HSL-3-GR	[kN]	33,5	40,3	40,3	42,2	58,9	58,9	51,5	77,5	78,7
Anchor size		M16			M20			M24			
Non-cracked concrete											
Tension N_{Rk}	HSL-3 / HSL-3-B HSL-3-G	[kN]	50,5	65,0	65,0	70,6	95,0	95,0	92,8	100,0	100,0
	HSL-3-R HSL-3-GR	[kN]	50,5	65,0	65,0	70,6	95,0	95,0	-	-	-
Shear V_{Rk}	HSL-3 / HSL-3-B	[kN]	101,0	141,2	158,5	141,2	186,0	186,0	185,5	204,5	204,5
	HSL-3-G	[kN]	101,0	120,6	120,6	141,2	155,3	155,3	185,5	204,5	204,5
	HSL-3-R	[kN]	101,0	128,2	128,2	141,2	145,2	145,2	-	-	-
	HSL-3-GR	[kN]	101,0	129,5	129,5	141,2	151,9	151,9	-	-	-

Anchor size		M16			M20			M24			
Cracked concrete											
Tension N_{Rk}	HSL-3 / HSL-3-B HSL-3-G	[kN]	36,0	36,0	36,0	50,3	50,0	50,0	66,1	65,0	65,0
	HSL-3-R HSL-3-GR		36,0	36,0	36,0	50,3	50,0	50,0	-	-	-
Shear V_{Rk}	HSL-3 / HSL-3-B	[kN]	72,0	100,6	132,3	100,6	138,9	181,2	132,3	173,9	204,5
	HSL-3-G		72,0	100,6	120,6	100,6	138,9	155,3	132,3	173,9	204,5
	HSL-3-R		72,0	100,6	128,2	100,6	138,9	145,2	-	-	-
	HSL-3-GR		72,0	100,6	129,5	100,6	138,9	151,9	-	-	-

a) HSL-3-SH, HSL-3-SK and HSL-3-SKR can only be set in position 1.

Effective anchorage depth ^{a)}

Anchor size		M8			M10			M12		
Eff. Anchorage depth h_{ef}	[mm]	$h_{ef,1}^{b)}$	$h_{ef,2}$	$h_{ef,3}$	$h_{ef,1}^{b)}$	$h_{ef,2}$	$h_{ef,3}$	$h_{ef,1}^{b)}$	$h_{ef,2}$	$h_{ef,3}$
		60	80	100	70	90	110	80	105	130
Anchor size		M16			M20			M24		
Eff. Anchorage depth h_{ef}	[mm]	$h_{ef,1}$	$h_{ef,2}$	$h_{ef,3}$	$h_{ef,1}$	$h_{ef,2}$	$h_{ef,3}$	$h_{ef,1}$	$h_{ef,2}$	$h_{ef,3}$
		100	125	150	125	155	185	150	180	210

a) HSL-3-SH, HSL-3-SK and HSL-3-SKR only available in sizes M8-M12

b) HSL-3-SH, HSL-3-SK and HSL-3-SKR can only be set in position 1.

Design resistance

Anchor size		M8			M10			M12			
Non-cracked concrete											
Tension N_{Rd}	HSL-3 / HSL-3-B HSL-3-G HSL-3-SH / HSL-3-SK ^{a)}	[kN]	13,0	19,5	19,5	19,7	28,7	31,1	24,1	36,2	44,9
	HSL-3-R / HSL-3-SKR ^{a)} HSL-3-GR		13,3	13,3	13,3	19,7	21,7	21,7	24,1	31,6	31,6
Shear V_{Rd}	HSL-3 / HSL-3-B	[kN]	24,9	24,9	24,9	39,4	48,4	48,4	48,2	71,7	71,7
	HSL-3-G		20,9	20,9	20,9	33,4	33,4	33,4	47,4	47,4	47,4
	HSL-3-SH / HSL-3-SK ^{a)}		24,9	-	-	39,4	-	-	48,2	-	-
	HSL-3-R, HSL-3-SKR ^{a)}		31,3	35,5	35,5	39,4	40,2	40,2	48,2	52,2	52,2
	HSL-3-GR		31,3	32,2	32,2	39,4	47,1	48,2	63,0	63,0	67,3
Cracked concrete											
Tension N_{Rd}	HSL-3 / HSL-3-B HSL-3-G HSL-3-SH / HSL-3-SK ^{a)}	[kN]	6,7	6,7	6,7	10,7	10,7	10,7	17,2	16,0	16,0
	HSL-3-R / HSL-3-SKR ^{a)} HSL-3-GR		8,0	8,0	8,0	10,7	10,7	10,7	17,2	16,0	16,0
Shear V_{Rd}	HSL-3 / HSL-3-B	[kN]	20,1	24,9	24,9	28,1	41,0	48,4	34,3	51,6	71,1
	HSL-3-G		20,1	20,9	20,9	28,1	33,4	33,4	34,3	47,4	47,4
	HSL-3-SH / HSL-3-SK ^{a)}		20,1	-	-	28,1	-	-	34,3	-	-
	HSL-3-R, HSL-3-SKR ^{a)}		22,3	34,3	35,5	28,2	40,2	40,2	34,4	51,6	52,2
	HSL-3-GR		22,3	32,2	32,2	28,1	41,0	47,1	34,3	51,6	63,0

Anchor size		M16			M20			M24			
Non-cracked concrete											
Tension N_{Rd}	HSL-3 / HSL-3-B HSL-3-G	[kN]	33,7	43,3	43,3	47,1	63,3	63,3	61,8	66,7	66,7
	HSL-3-R HSL-3-GR		33,7	43,3	43,3	47,1	63,3	63,3	-	-	-
Shear V_{Rd}	HSL-3 / HSL-3-B	[kN]	67,3	94,1	123,7	94,1	129,9	148,8	123,7	162,6	163,6
	HSL-3-G		67,3	94,1	96,5	94,1	124,2	124,2	123,7	162,6	163,6
	HSL-3-R		67,3	82,2	82,2	93,1	93,1	93,1	-	-	-
	HSL-3-GR		67,3	94,1	103,6	94,1	121,5	121,5	-	-	-
Cracked concrete											
Tension N_{Rd}	HSL-3 / HSL-3-B HSL-3-G	[kN]	24,0	24,0	24,0	33,5	33,3	33,3	44,1	43,3	43,3
	HSL-3-R HSL-3-GR		24,0	24,0	24,0	33,5	33,3	33,3	-	-	-
Shear V_{Rd}	HSL-3 / HSL-3-B	[kN]	48,0	67,1	88,2	67,1	92,6	120,8	88,2	115,9	146,1
	HSL-3-G		48,0	67,1	88,2	67,1	92,6	120,8	88,2	115,9	146,1
	HSL-3-R		48,0	67,1	82,2	67,1	92,6	93,1	-	-	-
	HSL-3-GR		48,0	67,1	88,2	67,1	92,6	120,8	-	-	-

a) HSL-3-SH, HSL-3-SK and HSL-3-SKR only available in sizes M8-M12

Effective anchorage depth ^{a)}

Anchor size		M8			M10			M12		
Eff. Anchorage depth	h_{ef} [mm]	$h_{ef,1}^{b)}$	$h_{ef,2}$	$h_{ef,3}$	$h_{ef,1}^{b)}$	$h_{ef,2}$	$h_{ef,3}$	$h_{ef,1}^{b)}$	$h_{ef,2}$	$h_{ef,3}$
		60	80	100	70	90	110	80	105	130
Anchor size		M16			M20			M24		
Eff. Anchorage depth	h_{ef} [mm]	$h_{ef,1}$	$h_{ef,2}$	$h_{ef,3}$	$h_{ef,1}$	$h_{ef,2}$	$h_{ef,3}$	$h_{ef,1}$	$h_{ef,2}$	$h_{ef,3}$
		100	125	150	125	155	185	150	180	210

a) HSL-3-SH, HSL-3-SK and HSL-3-SKR only available in sizes M8-M12

b) HSL-3-SH, HSL-3-SK and HSL-3-SKR can only be set in position 1.

Recommended loads ^{b)}

Anchor size		M8			M10			M12			
Non-cracked concrete											
Tension N_{Rec}	HSL-3 / HSL-3-B HSL-3-G	[kN]	9,3	14,0	14,0	14,1	20,5	22,2	17,2	25,9	32,1
	HSL-3-SH / HSL-3-SK ^{a)} HSL-3-R / HSL-3-SKR ^{a)} HSL-3-GR		9,5	9,5	9,5	14,1	15,5	15,5	17,2	22,5	22,5
48,1	HSL-3 / HSL-3-B	[kN]	17,8	17,8	17,8	28,2	34,6	34,6	34,4	51,2	51,2
	HSL-3-G		14,9	14,9	14,9	23,9	23,9	23,9	33,9	33,9	33,9
	HSL-3-SH / HSL-3-SK ^{a)}		17,8	-	-	28,2	-	-	34,4	-	-
	HSL-3-R, HSL-3-SKR ^{a)}		22,4	25,4	25,4	28,2	28,7	28,7	34,4	37,3	37,3
	HSL-3-GR		22,4	23,0	23,0	28,2	33,7	33,7	34,4	45,0	45,0
Cracked concrete											
Tension N_{Rec}	HSL-3 / HSL-3-B HSL-3-G	[kN]	4,8	4,8	4,8	7,6	7,6	7,6	12,3	11,4	11,4
	HSL-3-SH / HSL-3-SK ^{a)} HSL-3-R / HSL-3-SKR ^{a)} HSL-3-GR		5,7	5,7	5,7	7,6	7,6	7,6	12,3	11,4	11,4
Shear V_{Rec}	HSL-3 / HSL-3-B	[kN]	14,3	17,8	17,8	20,1	29,3	34,6	24,5	36,9	50,8
	HSL-3-G		14,3	14,9	14,9	20,1	23,9	23,9	24,5	33,9	33,9
	HSL-3-SH / HSL-3-SK ^{a)}		14,3	-	-	20,1	-	-	24,5	-	-
	HSL-3-R, HSL-3-SKR ^{a)}		15,9	24,5	25,4	20,1	28,7	28,7	24,5	36,9	37,3
	HSL-3-GR		15,9	23,0	23,0	20,1	29,3	33,7	24,5	36,9	45,0

Anchor size		M16			M20			M24			
Non-cracked concrete											
Tension N_{Rec}	HSL-3 / HSL-3-B HSL-3-G	[kN]	24,0	31,0	31,0	33,6	45,2	45,2	44,2	47,6	47,6
	HSL-3-R HSL-3-GR		24,0	31,0	31,0	33,6	45,2	45,2	-	-	-
Shear V_{Rec}	HSL-3 / HSL-3-B	[kN]	48,1	67,2	88,4	67,2	92,8	106,3	88,4	116,1	116,9
	HSL-3-G		48,1	67,2	68,9	67,2	88,7	88,7	88,4	116,1	116,9
	HSL-3-R		48,1	58,7	58,7	66,5	66,5	66,5	-	-	-
	HSL-3-GR		48,1	67,2	74,0	67,2	86,8	86,8	-	-	-
Cracked concrete											
Tension N_{Rec}	HSL-3 / HSL-3-B HSL-3-G	[kN]	17,1	17,1	17,1	24,0	23,8	23,8	31,5	31,0	31,0
	HSL-3-R HSL-3-GR		17,1	17,1	17,1	24,0	23,8	23,8	-	-	-
Shear V_{Rec}	HSL-3 / HSL-3-B	[kN]	34,3	47,9	63,0	47,9	66,2	86,3	63,0	82,8	104,3
	HSL-3-G		34,3	47,9	63,0	47,9	66,2	86,3	63,0	82,8	104,3
	HSL-3-R		34,3	47,9	58,7	47,9	66,2	66,5	-	-	-
	HSL-3-GR		34,3	47,9	63,0	47,9	66,2	86,3	-	-	-

a) HSL-3-SH, HSL-3-SK and HSL-3-SKR only available in sizes M8-M12.

b) With overall partial safety factor for action $\gamma = 1,4$. The partial safety factors for action depend on thy type of loading and shall be taken from national regulations.

Seismic resistance (for a single anchor)

All data in this section applies to:

- Correct setting (See setting instruction)
- No edge distance and spacing influence
- Steel failure
- Minimum base material thickness
- Concrete C 20/25, $f_{ck,cube}=25 \text{ N/mm}^2$
- $\alpha_{gap} = 0,5$
- Values for HSL-3-R, HSL-3-SKR and HSL-3-GR only applicable for hammer drilling

Effective anchorage depth for seismic C2^{a)}

Anchor size	M10			M12			M16			M20		
	$h_{ef,1}$	$h_{ef,2}$	$h_{ef,3}$	$h_{ef,1}$	$h_{ef,2}$	$h_{ef,3}$	$h_{ef,1}$	$h_{ef,2}$	$h_{ef,3}$	$h_{ef,1}$	$h_{ef,2}$	$h_{ef,3}$
Eff. Anchorage depth h_{ef} [mm]	70	90	110	80	105	130	100	125	150	125	155	185

a) HSL-3-SH and HSL-3-SK can only be set in position 1 and only available in sizes M8-M12.

Characteristic resistance in case of seismic category C2

Anchor size		M10			M12			M16			M20			
Tension $N_{Rk,seis}$	HSL-3 / HSL-3-B HSL-3-G	[kN]	12,2	12,2	12,2	21,9	25,8	25,8	30,6	34,2	34,2	40,1	40,1	40,1
	HSL-3-SH / HSL-3-SK		12,2	-	-	21,9	-	-	-	-	-	-	-	-
Shear $V_{Rk,seis}$	HSL-3 / HSL-3-B	[kN]	9,4	9,4	9,4	13,2	13,2	13,2	25,4	25,4	25,4	39,1	39,1	39,1
	HSL-3-G		9,0	9,0	9,0	11,3	11,3	11,3	22,3	22,3	22,3	25,1	25,1	25,1
	HSL-3-SH / HSL-3-SK		9,4	-	-	13,2	-	-	-	-	-	-	-	-

Design resistance in case of seismic category C2

Anchor size		M10			M12			M16			M20			
Tension $N_{Rd,seis}$	HSL-3 / HSL-3-B HSL-3-G	[kN]	8,1	8,1	8,1	14,6	17,2	17,2	20,4	22,8	22,8	26,7	26,7	26,7
	HSL-3-SH / HSL-3-SK		8,1	-	-	14,6	-	-	-	-	-	-	-	-
Shear $V_{Rd,seis}$	HSL-3 / HSL-3-B	[kN]	7,5	7,5	7,5	10,5	10,5	10,5	20,3	20,3	20,3	31,2	31,2	31,2
	HSL-3-G		7,2	7,2	7,2	9,0	9,0	9,0	17,8	17,8	17,8	20,1	20,1	20,1
	HSL-3-SH / HSL-3-SK		7,5	-	-	10,5	-	-	-	-	-	-	-	-

Effective anchorage depth for seismic C1 ^{a)}

Anchor size			M8			M10			M12		
Eff. Anchorage depth	h_{ef}	[mm]	$h_{ef,1}^{b)}$	$h_{ef,2}$	$h_{ef,3}$	$h_{ef,1}^{b)}$	$h_{ef,2}$	$h_{ef,3}$	$h_{ef,1}^{b)}$	$h_{ef,2}$	$h_{ef,3}$
			60	80	100	70	90	110	80	105	130
Anchor size			M16			M20			M24		
Eff. Anchorage depth	h_{ef}	[mm]	$h_{ef,1}$	$h_{ef,2}$	$h_{ef,3}$	$h_{ef,1}$	$h_{ef,2}$	$h_{ef,3}$	$h_{ef,1}$	$h_{ef,2}$	$h_{ef,3}$
			100	125	150	125	155	185	150	180	210

a) HSL-3-SH, HSL-3-SK and HSL-3-SKR only available in sizes M8-M12

b) HSL-3-SH, HSL-3-SK and HSL-3-SKR can only be set in position 1.

Characteristic resistance in case of seismic category C1

Anchor size			M8			M10			M12		
Tension $N_{Rk,seis}$	HSL-3 / HSL-3-B HSL-3-G	[kN]	12,0	12,0	12,0	16,0	16,0	16,0	21,9	24,0	24,0
	HSL-3-SH / HSL-3-SK		12,0	-	-	16,0	-	-	21,9	-	-
	HSL-3-R / HSL-3-SKR		12,0	12,0	12,0	16,0	16,0	16,0	21,9	24,0	24,0
Shear $V_{Rk,seis}$	HSL-3 / HSL-3-B	[kN]	8,9	8,9	8,9	22,1	22,1	22,1	29,1	29,1	29,1
	HSL-3-G		7,5	7,5	7,5	15,3	15,3	15,3	19,3	19,3	19,3
	HSL-3-SH / HSL-3-SK ^{a)}		8,9	-	-	22,1	-	-	29,1	-	-
	HSL-3-R / HSL-3-SKR		5,2	5,2	5,2	12,9	12,9	12,9	14,0	14,0	14,0
Anchor size			M16			M20			M24		
Tension $N_{Rk,seis}$	HSL-3 / HSL-3-B HSL-3-G	[kN]	30,6	36,0	36,0	42,8	50,0	50,0	56,2	65,0	65,0
	HSL-3-R / HSL-3-SKR		30,6	36,0	36,0	42,8	50,0	50,0	56,2	65,0	65,0
	HSL-3 / HSL-3-B		57,1	57,1	57,1	54,9	54,9	54,9	81,8	81,8	81,8
Shear $V_{Rk,seis}$	HSL-3-G	[kN]	43,4	43,4	43,4	45,8	45,8	45,8	-	-	-
	HSL-3-R / HSL-3-SKR		29,6	29,6	29,6	29,6	29,6	29,6	-	-	-

Design resistance in case of seismic category C1

Anchor size			M8			M10			M12		
Tension $N_{Rd,seis}$	HSL-3 / HSL-3-B HSL-3-G	[kN]	6,7	6,7	6,7	10,7	10,7	10,7	14,6	16,0	16,0
	HSL-3-SH / HSL-3-SK		6,7	-	-	10,7	-	-	14,6	-	-
	HSL-3-R / HSL-3-SKR		8,0	8,0	8,0	10,7	10,7	10,7	14,6	16,0	16,0
Shear $V_{Rd,seis}$	HSL-3 / HSL-3-B	[kN]	7,1	7,1	7,1	17,7	17,7	17,7	23,3	23,3	23,3
	HSL-3-G		6,0	6,0	6,0	12,2	12,2	12,2	15,4	15,4	15,4
	HSL-3-SH / HSL-3-SK		7,1	-	-	17,7	-	-	23,3	-	-
	HSL-3-R / HSL-3-SKR		4,2	4,2	4,2	8,3	8,3	8,3	9,0	9,0	9,0
Anchor size			M16			M20			M24		
Tension $N_{Rd,seis}$	HSL-3 / HSL-3-B HSL-3-G	[kN]	20,4	24,0	24,0	28,5	33,3	33,3	37,5	43,3	43,3
	HSL-3-R / HSL-3-SKR		20,4	24,0	24,0	28,5	33,3	33,3	-	-	-
	HSL-3 / HSL-3-B		40,8	45,6	45,6	43,9	43,9	43,9	65,4	65,4	65,4
Shear $V_{Rk,seis}$	HSL-3-G	[kN]	34,7	34,7	34,7	36,6	36,6	36,6	-	-	-
	HSL-3-R / HSL-3-SKR		19,0	19,0	19,0	19,0	19,0	19,0	-	-	-

Materials

Mechanical properties

Anchor size		M8	M10	M12	M16	M20	M24
HSL-3, HSL-3-G, HSL-3-B, HSL-3-SH, HSL-3-SK							
Nominal tensile strength f_{uk}	[N/mm ²]	800	800	800	800	830	830
Yield strength f_{yk}	[N/mm ²]	640	640	640	640	640	640
Stressed cross-section A_s	[mm ²]	36,6	58,0	84,3	157	245	353
Moment of resistance W	[mm ³]	31,3	62,5	109,4	277,1	540,6	935,4
Design bending resistance without sleeve $M_{Rd,s}$	[Nm]	24,0	48,0	84,0	212,8	415,2	718,4
HSL-3-R, HSL-3-GR, HSL-3-SKR							
Nominal tensile strength f_{uk}	[N/mm ²]	700	700	700	700	700	-
Yield strength f_{yk}	HSL-3-R	560	450	450	450	450	-
	HSL-3-SKR						
	HSL-3-GR	560	560	560	560	560	-
Stressed cross-section A_s	[mm ²]	36,6	58,0	84,3	157	245	-
Moment of resistance W	[mm ³]	31,3	62,5	109,4	277,1	540,6	-
Design bending resistance without sleeve $M_{Rd,s}$	[Nm]	16,8	33,5	58,8	149,4	291,3	-

Material quality

Part	Material
Carbon Steel	
HSL-3 Cone	Carbon steel, galvanized to $\geq 5 \mu\text{m}$
HSL-3-G Expansion sleeve	Carbon steel, galvanized to $\geq 5 \mu\text{m}$
HSL-3-B Collapsible element	POM Plastic element
HSL-3-SH Distance sleeve	Carbon steel, galvanized to $\geq 5 \mu\text{m}$
HSL-3 Washer	Carbon steel, galvanized to $\geq 5 \mu\text{m}$
HSL-3 Hexagonal bolt	Carbon steel, galvanized to $\geq 5 \mu\text{m}$, rupture elongation $\geq 12\%$
HSL-3-G Hexagonal nut	Carbon steel, galvanized to $\geq 5 \mu\text{m}$
HSL-3-G Threaded rod	Carbon steel, galvanized to $\geq 5 \mu\text{m}$, rupture elongation $\geq 12\%$
HSL-3-B Hexagonal bolt with safety cap	Carbon steel, galvanized to $\geq 5 \mu\text{m}$, rupture elongation $\geq 12\%$
HSL-3-SH Hexagonal socket head screw	Carbon steel, galvanized to $\geq 5 \mu\text{m}$, rupture elongation $\geq 12\%$
HSL-3-SK Countersunk bolt	Carbon steel, galvanized to $\geq 5 \mu\text{m}$, rupture elongation $\geq 12\%$
HSL-3-SK Cup washer	Carbon steel, galvanized to $\geq 5 \mu\text{m}$
Stainless Steel	
HSL-3-R Cone	Stainless steel A4, coated
HSL-3-R Expansion sleeve	Stainless steel A4
HSL-3-GR Collapsible element	Plastic element
HSL-3-SKR Distance sleeve	Stainless steel A4
HSL-3-R Washer	Stainless steel A4, coated
HSL-3-R Hexagonal bolt	Stainless steel A4, coated, rupture elongation $\geq 12\%$
HSL-3-GR Hexagonal nut	Stainless steel A4, coated
HSL-3-GR Threaded rod	Stainless steel A4, coated, rupture elongation $\geq 12\%$
HSL-3-SKR Countersunk bolt	Stainless steel A4, coated, rupture elongation $\geq 12\%$
HSL-3-SKR Cup washer	Stainless steel A4, coated

Anchor dimensions of HSL-3, HSL-3-G, HSL-3-B, HSL-3-B, HSL-3-SH, HSL-3-SK

Anchor version	Thread size	t _{fix} [mm]		d _s [mm]	l ₁ [mm]	l ₂ [mm]	l ₃ [mm]	l ₄ [mm]		p [mm]
		min	max					min	max	
HSL-3	M8	5	200	11,9	12	32	15,2	19	214	2
HSL-3-G	M10	5	200	14,8	14	36	17,2	23	218	3
HSL-3	M12	5	200	17,6	17	40	20	28	223	3
HSL-3-G	M16	10	200	23,6	20	54,4	24,4	34,5	224,5	4
HSL-3-B	M20	10	200	27,6	20	57	31,5	51	241	4
HSL-3	M24	10	200	31,6	22	65	39	57	247	4
HSL-3-SH	M8	5		11,9	12	32	15,2	19		2
	M10	20		14,8	14	36	17,2	38		3
	M12	25		17,6	17	40	20	48		3
HSL-3-SK	M8	10	20	11,9	12	32	15,2	18,2	28,2	2
	M10	20		14,8	14	36	17,2	32,2		3
	M12	25		17,6	17	40	20	40		3

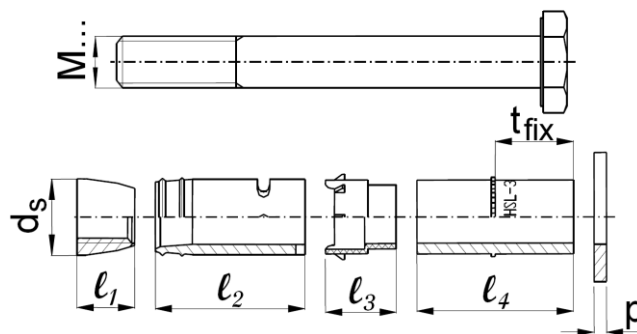

Setting information

Setting positions a)

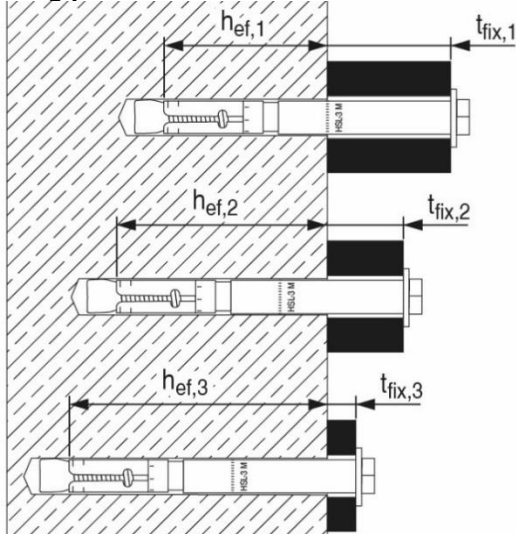

Setting position

①

Setting position

②

Setting position

③

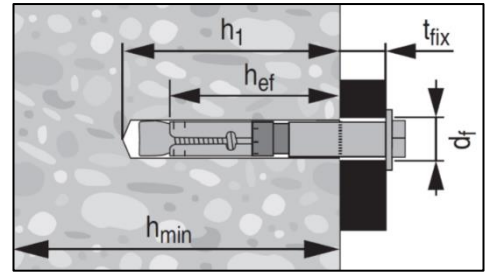

a) HSL-3-SH, HSL-3-SK and HSL-3-SKR can only be set in position 1.

Setting details for HSL-3 / HSL-3-R

Anchor version		M8			M10			M12		
Nominal diameter of drill bit	d_0 [mm]	12			15			18		
Max. cutting diameter of drill bit	d_{cut} [mm]	12,5			15,5			18,5		
Max. diameter of clearance hole in the fixture	d_f [mm]	14			17			20		
Setting position	i	①	②	③	①	②	③	①	②	③
Fixture thickness	$t_{fix,1}$ [mm]	5-200			5-200			5-200		
Effective fixture thickness	$t_{fix,i}$	$t_{fix,1}^{1)} - \Delta i$								
Reduction of fixture thickness	Δi [mm]	0	20	40	0	20	40	0	25	50
Effective anchorage depth	$h_{ef,i}$ [mm]	60	80	100	70	90	110	80	105	130
Min. depth of drill hole	$h_{1,i}$ [mm]	80	100	120	90	110	130	105	130	155
Min. thickness of concrete member	$h_{min,i}$ [mm]	120	170	195	140	195	215	160	225	250
Width across flats	SW [mm]	13			17			19		
Installation torque (HSL-3-R)	T_{inst} [Nm]	25			50 (35)			80		
Anchor version		M16			M20			M24 a)		
Nominal diameter of drill bit	d_0 [mm]	24			28			32		
Max. cutting diameter of drill bit	d_{cut} [mm]	24,55			28,55			32,7		
Max. diameter of clearance hole in the fixture	d_f [mm]	26			31			35		
Setting position	i	①	②	③	①	②	③	①	②	③
Fixture thickness	t_{fix1} [mm]	10-200			10-200			10-200		
Effective fixture thickness	$t_{fix,i}$	$t_{fix,1}^{1)} - \Delta i$								
Reduction of fixture thickness	Δi [mm]	0	25	50	0	30	60	0	30	60
Effective anchorage depth	$h_{ef,i}$ [mm]	100	125	150	125	155	185	150	180	210
Min. depth of drill hole	$h_{1,i}$ [mm]	125	150	175	155	185	215	180	210	240
Min. thickness of concrete member	$h_{min,i}$ [mm]	200	275	300	250	380	410	300	405	435
Width across flats	SW [mm]	24			30			36		
Installation torque	T_{inst} [Nm]	120			200			250		

a) Anchor version M24 only available for HSL-3 carbon steel version.

Setting details for HSL-3-G / HSL-3-GR

Anchor version					M8			M10			M12		
Nominal diameter of drill bit	d ₀	[mm]	12			15			18				
Max. cutting diameter of drill bit	d _{cut}	[mm]	12,5			15,5			18,5				
Max. diameter of clearance hole in the fixture	d _f	[mm]	14			17			20				
Setting position	i		①	②	③	①	②	③	①	②	③		
Fixture thickness	t _{fix,1}	[mm]	5-200			5-200			5-200				
Effective fixture thickness	t _{fix,i}		t _{fix,1} ¹⁾ - Δi										
Reduction of fixture thickness	Δi	[mm]	0	20	40	0	20	40	0	25	50		
Effective anchorage depth	h _{ef,i}	[mm]	60	80	100	70	90	110	80	105	130		
Min. depth of drill hole	h _{1,i}	[mm]	80	100	120	90	110	130	105	130	155		
Min. thickness of concrete member	h _{min,i}	[mm]	120	170	190 ^{a)} / 195	140	195	215	160	225	250		
Width across flats	SW	[mm]	13			17			19				
Installation torque	T _{inst}	[Nm]	20 (30)			35 (50)			60 (80)				
Anchor version		M16			M20			M24 ^{a)}					
Nominal diameter of drill bit	d ₀	[mm]	24			28			32				
Max. cutting diameter of drill bit	d _{cut}	[mm]	24,55			28,55			32,7				
Max. diameter of clearance hole in the fixture	d _f	[mm]	26			31			35				
Setting position	i		①	②	③	①	②	③	①	②	③		
Fixture thickness	t _{fix1}	[mm]	10-200			10-200			10-200				
Effective fixture thickness	t _{fix,i}		t _{fix,1} ¹⁾ - Δi										
Reduction of fixture thickness	Δi	[mm]	0	25	50	0	30	60	0	30	60		
Effective anchorage depth	h _{ef,i}	[mm]	100	125	150	125	155	185	150	180	210		
Min. depth of drill hole	h _{1,i}	[mm]	125	150	175	155	185	215	180	210	240		
Min. thickness of concrete member	h _{min,i}	[mm]	200	275	300	250	380	410	300	405	435		
Width across flats	SW	[mm]	24			30			36				
Installation torque	T _{inst}	[Nm]	80 (120)			160 (200)			180				

a) Anchor version M24 only available for HSL-3-G carbon steel version.

Setting details for HSL-3-B

Anchor version					M12			M16			M20			M24		
Nominal diameter of drill bit	d ₀	[mm]	18			24			28			32				
Max. cutting diameter of drill bit	d _{cut}	[mm]	18,5			24,55			28,55			32,7				
Max. diameter of clearance hole in the fixture	d _f	[mm]	20			26			31			35				
Setting position	i		①	②	③	①	②	③	①	②	③	①	②	③		
Fixture thickness	t _{fix,1}	[mm]	5 - 200			10 - 200			10 - 200			10 - 200				
Effective fixture thickness	t _{fix,i}		t _{fix,1} ¹⁾ - Δi													
Reduction of fixture thickness	Δi	[mm]	0	25	50	0	25	50	0	30	60	0	30	60		
Effective anchorage depth	h _{ef,i}	[mm]	80	105	130	100	125	150	125	155	185	150	180	210		
Min. depth of drill hole	h _{1,i}	[mm]	105	130	155	125	150	175	155	185	215	180	210	240		
Min. thickness of concrete member	h _{min,i}	[mm]	160	225	250	200	275	300	250	380	410	300	405	435		
Width across flats	SW	[mm]	24			30			36			41				
Installation torque	T _{inst}	[Nm]	The torque moment is controlled by the safety cap													

Setting details for HSL-3-SH^{a)}

Anchor version		M8	M10	M12
Nominal diameter of drill bit	d_0 [mm]	12	15	18
Max. cutting diameter of drill bit	d_{cut} [mm]	12,5	15,5	18,5
Max. diameter of clearance hole in the fixture	d_f [mm]	14	17	20
Fixture thickness	t_{fix} [mm]	5	20	25
Effective anchorage depth	h_{ef} [mm]	60	70	80
Min. depth of drill hole	h_1 [mm]	85	95	110
Min. thickness of concrete member	h_{min} [mm]	120	140	160
Width across flats	SW [mm]	6	8	10
Installation torque	T_{inst} [Nm]	25	35	60

a) HSL-3-SH, HSL-3-SK and HSL-3-SKR can only be set in position 1.

Setting details for HSL-3-SK / HSL-3-SKR ^{a)}

Anchor version		M8	M10	M12
Nominal diameter of drill bit	d_0 [mm]	12	15	18
Max. cutting diameter of drill bit	d_{cut} [mm]	12,5	15,5	18,5
Max. diameter of clearance hole in the fixture	d_f [mm]	14	17	20
Top diameter of countersunk head in the fixture	d_h [mm]	22,5	25,5	32,9
Bottom diameter of countersunk head in the fixture	d_h [mm]	11,4	14,4	17,4
Height of the countersunk head in the fixture	h_{cs} [mm]	5,8	6,0	8,0
Fixture thickness	t_{fix} [mm]	10 – 20	20	25
Effective anchorage depth	h_{ef} [mm]	60	70	80
Min. depth of drill hole	h_1 [mm]	80	90	105
Min. thickness of concrete member	h_{min} [mm]	120	140	160
Width across flats	SW [mm]	5	6	8
Installation torque	T_{inst} [Nm]	25 (18)	50	80

a) HSL-3-SH, HSL-3-SK and HSL-3-SKR can only be set in position 1.

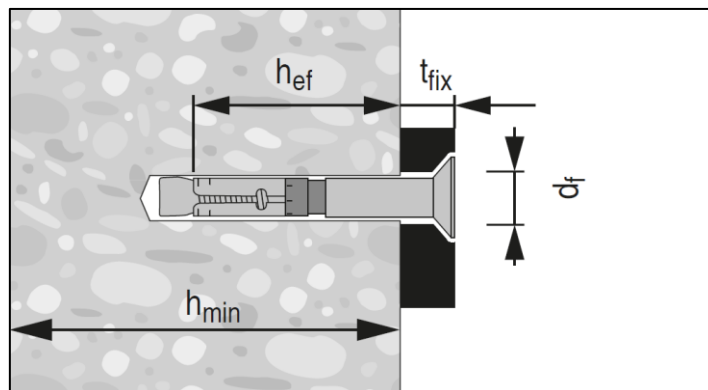

Installation equipment

Anchor size	M8	M10	M12	M16	M20	M24
Rotary hammer	TE 2 – TE 30			TE 40 – TE 80		
Diamond coring ¹⁾	DD 30-W + SPX-T				DD 30-W + SPX-T DD 120 + DD-BI	
Other tools	blow out pump, hammer, torque wrench ²⁾					

1) Diamond coring not available for HSL-3-R, HSL-3-GR and HSL-3-SKR anchors.

2) HSL-3-B only requires a regular wrench as it automatically ensures correct torque is applied.

Setting parameters for HSL-3, HSL-3-G, HSL-3-B, HSL-3-SH, HSL-3-SK

Anchor size		M8			M10			M12		
Setting position	i	①	②	③	①	②	③	①	②	③
Minimum base material thickness	h_{min} [mm]	120	170	190	140	195	215	160	225	250
Minimum spacing	s_{min} [mm]	60			70			80		
	for $c \geq$ [mm]	100			100			160		
Minimum edge distance	c_{min} [mm]	60			70			80		
	for $s \geq$ [mm]	100			160			240		
Anchor size		M16			M20			M24		
Setting position	i	①	②	③	①	②	③	①	②	③
Minimum base material thickness	h_{min} [mm]	200	275	300	250	380	410	300	405	435
Minimum spacing	s_{min} [mm]	100			125			150		
	for $c \geq$ [mm]	240			300			300		
Minimum edge distance	c_{min} [mm]	100			150			150		
	for $s \geq$ [mm]	240			300			300		

Setting parameters for HSL-3-R, HSL-3-GR, HSL-3-SKR

Anchor size		M8			M10			M12			M14			M20		
Setting position	i	①	②	③	①	②	③	①	②	③	①	②	③	①	②	③
Minimum base material thickness	h_{min} [mm]	120	170	195	140	195	215	160	225	250	200	275	300	250	380	410
Non-cracked concrete																
Minimum spacing	s_{min} [mm]	70			70			80			100			125		
	for $c \geq$ [mm]	100			100			160			240			300		
Minimum edge distance	c_{min} [mm]	70			80			80			100			150		
	for $s \geq$ [mm]	140			160			240			240			300		
Cracked concrete																
Minimum spacing	s_{min} [mm]	70			70			80			100			125		
	for $c \geq$ [mm]	100			100			170			240			300		
Minimum edge distance	c_{min} [mm]	70			120			80			100			150		
	for $s \geq$ [mm]	140			160			240			240			300		

Setting instructions

*For detailed information on installation of each specific HSL-3 versions see instruction for use given with the package of the product.

Setting instruction	
Hammer drilling	
1. Drilling 	2. Cleaning
3. Installation 	4. Applying tightening torque
Diamond drilling for HSL-3, HSL-3-B, HSL-3-G, HSL-3-SK, HSL-3-SH	
1. Drilling 	2. Cleaning
3. Installation 	4. Applying tightening torque

HSL-3-B Safety cap

Hammer drilling

1. Drilling

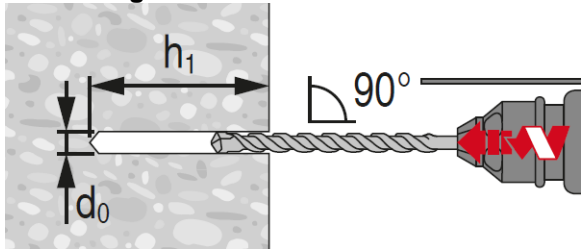

2. Cleaning

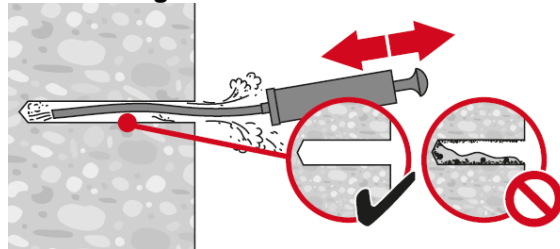

3. Installation

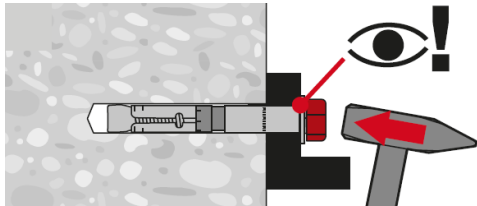

4. Applying torque

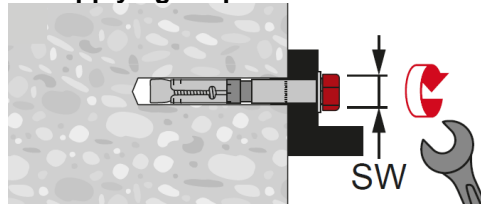

5. Throw safety cap away

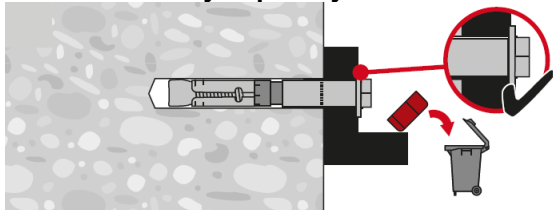

Diamond drilling

1. Drilling

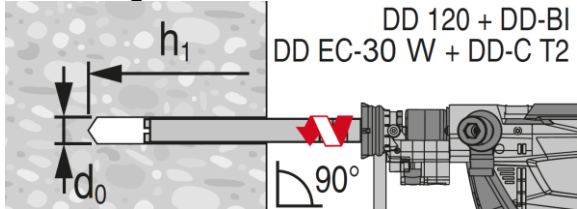

2. Cleaning

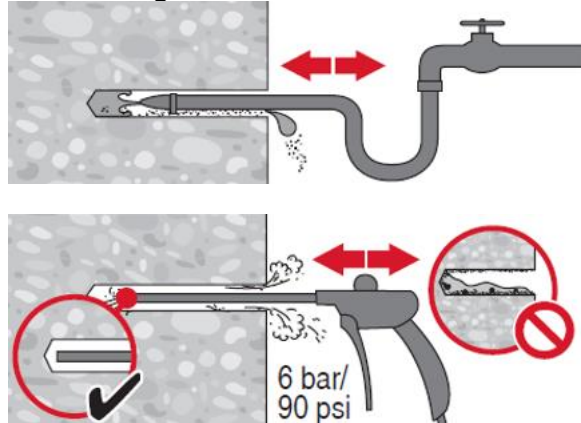

3. Installation

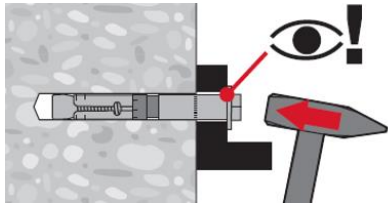

4. Applying tightening torque

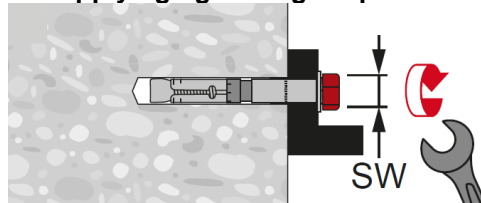

5. Throw the safety cap away

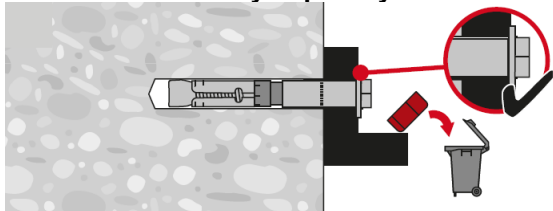

HST3 Expansion anchor

Ultimate-performance expansion anchor for cracked concrete and seismic

Chemical anchors

Mechanical anchors Expansion

Plastic/Light duty metal anchors

Insulation anchors

Anchor version



HST3
HST3-R
(M8-M24)



HST3-BW
HST3-R-BW
(M8-M24)

Benefits

- Highest resistance for reduced member thickness, short spacing and edge distances
- Increased undercut percentage in combination with optimized coating
- Suitable for non-cracked and cracked concrete C 12/15 to C 80/95
- Highly reliable and safe anchor for structural seismic design with ETA C1/C2 approval
- Flexibility with two embedment depths included in the ETA
- Minimum edge and spacing distances reduced by up to 25% compared to HST
- Design tension resistance increased by up to 66% compared to HST
- Product and length identification mark facilitates quality control and inspection

Base material



Concrete (non-cracked)



Concrete (cracked)

Load conditions

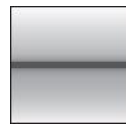

Static/
quasi-static



Seismic
ETA-C1/C2



Fire
resistance

Installation conditions

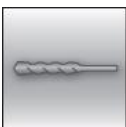

Hammer
drilled holes



Diamond
drilled holes

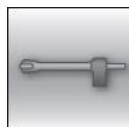

Hollow drill-
bit drilling

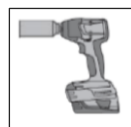

Impact wrench
with adaptative
torque module

Other information



European
Technical
Assessment



CE
conformity



PROFIS
Anchor design
Software



FM
approved

Approvals / certificates

Description	Authority / Laboratory	No. / date of issue
European technical assessment ^{a)}	DIBt, Berlin	ETA-98/0001 / 2018-02-09
Fire test report	DIBt, Berlin	ETA-98/0001 / 2018-02-09
Shock approval	FOCP, Zurich	BZS D 08-602 / 2016-08-17

^{a)} All data given in this section according to ETA-98/0001, issue 2017-20-07.

Static and quasi-static loading (for a single anchor)

All data in this section applies to:

- Correct setting (See setting instruction)
- No edge distance and spacing influence
- **Steel** failure
- Minimum base material thickness
- Concrete C 20/25, $f_{ck,cube} = 25 \text{ N/mm}^2$

Effective anchorage depth for static

Anchor size			M8	M10		M12		M16		M20	M24
Eff. Anchorage depth	h_{ef}	[mm]	47	40	60	50	70	65	85	101	125

Mean ultimate resistance

Anchor size			M8	M10		M12		M16		M20	M24
Non-cracked concrete											
Tension $N_{Ru,m}$	HST3/HST3-BW	[kN]	15,9	17,0	29,2	23,7	33,2	35,1	52,5	68,1	79,7
	HST3-R/HST3-R-BW		15,9	17,0	29,2	23,7	33,2	35,1	52,5	68,1	79,7
Shear $V_{Ru,m}$	HST3/HST3-BW	[kN]	14,5	23,0	24,8	35,7	37,2	57,2	58,1	88,1	98,7
	HST3-R/HST3-R-BW		16,5	26,9	26,6	32,7	38,5	51,0	66,8	102,1	120,8
Cracked concrete											
Tension $N_{Ru,m}$	HST3/HST3-BW	[kN]	10,6	12,1	19,9	16,9	26,6	25,0	37,5	48,5	53,1
	HST3-R/HST3-R-BW		11,3	12,1	19,9	16,9	26,6	25,0	37,5	48,5	53,1
Shear $V_{Ru,m}$	HST3/HST3-BW	[kN]	14,5	23,0	24,8	35,7	37,2	57,2	58,1	88,1	98,7
	HST3-R/HST3-R-BW		16,5	26,9	26,6	32,7	38,5	51,0	66,8	102,1	120,8

Characteristic resistance

Anchor size			M8	M10		M12		M16		M20	M24
Non-cracked concrete											
Tension N_{Rk}	HST3/HST3-BW	[kN]	12,0	12,8	22,0	17,9	25,0	26,5	39,6	51,3	60,0
	HST3-R/HST3-R-BW		12,0	12,8	22,0	17,9	25,0	26,5	39,6	51,3	60,0
Shear V_{Rk}	HST3/HST3-BW	[kN]	13,8	21,9	23,6	34,0	35,4	54,5	55,3	83,9	94,0
	HST3-R/HST3-R-BW		15,7	25,6	25,3	31,1	36,7	48,6	63,6	97,2	115,0
Cracked concrete											
Tension N_{Rk}	HST3/HST3-BW	[kN]	8,0	9,1	15,0	12,7	20,0	18,9	28,2	36,5	40,0
	HST3-R/HST3-R-BW		8,5	9,1	15,0	12,7	20,0	18,9	28,2	36,5	40,0
Shear V_{Rk}	HST3/HST3-BW	[kN]	13,8	21,9	23,6	34,0	35,4	54,5	55,3	83,9	94,0
	HST3-R/HST3-R-BW		15,7	24,3	25,3	31,1	36,7	48,6	63,6	97,2	115,0

Design resistance

Anchor size		M8	M10	M12	M16	M20	M24				
Non-cracked concrete											
Tension N_{Rd}	HST3/HST3-BW	[kN]	8,0	8,5	14,7	11,9	16,7	17,6	26,4	34,2	40,0
	HST3-R/HST3-R-BW	[kN]	8,0	8,5	14,7	11,9	16,7	17,6	26,4	34,2	40,0
Shear V_{Rd}	HST3/HST3-BW	[kN]	11,0	17,5	18,9	27,2	28,3	43,6	44,2	67,1	62,7
	HST3-R/HST3-R-BW	[kN]	12,6	20,5	20,2	24,9	29,4	38,9	50,9	77,8	88,5
Cracked concrete											
Tension N_{Rd}	HST3/HST3-BW	[kN]	5,3	6,1	10,0	8,5	13,3	12,6	18,8	24,4	26,7
	HST3-R/HST3-R-BW	[kN]	5,7	6,1	10,0	8,5	13,3	12,6	18,8	24,4	26,7
Shear V_{Rd}	HST3/HST3-BW	[kN]	11,0	16,2	18,9	23,6	28,3	42,9	44,2	67,1	62,7
	HST3-R/HST3-R-BW	[kN]	12,6	16,2	20,2	23,6	29,4	38,9	50,9	77,8	83,9

Recommended loads^{a)}

Anchor size		M8	M10	M12	M16	M20	M24				
Non-cracked concrete											
Tension N_{Rec}	HST3/HST3-BW	[kN]	5,7	6,1	10,5	8,5	11,9	12,6	18,8	24,4	28,6
	HST3-R/HST3-R-BW	[kN]	5,7	6,1	10,5	8,5	11,9	12,6	18,8	24,4	28,6
Shear V_{Rec}	HST3/HST3-BW	[kN]	7,9	12,5	13,5	19,4	20,2	31,1	31,6	47,9	44,8
	HST3-R/HST3-R-BW	[kN]	9,0	14,6	14,5	17,8	21,0	27,8	36,3	55,5	63,2
Cracked concrete											
Tension N_{Rec}	HST3/HST3-BW	[kN]	3,8	4,3	7,1	6,1	9,5	9,0	13,4	17,4	19,0
	HST3-R/HST3-R-BW	[kN]	4,0	4,3	7,1	6,1	9,5	9,0	13,4	17,4	19,0
Shear V_{Rec}	HST3/HST3-BW	[kN]	7,9	11,6	13,5	16,8	20,2	30,6	31,6	47,9	44,8
	HST3-R/HST3-R-BW	[kN]	9,0	11,6	14,5	16,8	21,0	27,8	36,3	55,5	59,9

a) With overall partial safety factor for action $\gamma = 1,4$. The partial safety factors for action depend on the type of loading and shall be taken from national regulations,

Seismic loading (for a single anchor)

All data in this section applies to:

- Correct setting (See setting instruction)
- No edge distance and spacing influence
- *Steel* failure
- Minimum base material thickness
- Concrete C 20/25, $f_{ck,cube} = 25 \text{ N/mm}^2$
- $\alpha_{gap} = 1,0$ (using Hilti seismic filling set)

Effective anchorage depth for seismic C2 and C1

Anchor size	M8	M10	M12	M16	M20	M24
Eff, Anchorage depth h_{ef} [mm]	47	60	70	85	101	-

Characteristic resistance in case of seismic performance C2

Anchor size	M8	M10	M12	M16	M20	M24		
Tension $N_{Rk,seis}$	HST3 / HST3-BW	[kN]	3,0	10,4	17,9	24,0	31,1	-
	HST3-R / HST3-R-BW	[kN]	3,4	10,4	17,9	24,0	31,1	-
Shear $V_{Rk,seis}$	HST3 / HST3-BW	[kN]	9,9	19,0	28,6	48,5	84,3	-
	HST3-R / HST3-R-BW	[kN]	9,9	17,2	27,6	42,5	67,4	-

Design resistance in case of seismic performance C2

Anchor size		M8	M10	M12	M16	M20	M24
Tension $N_{Rd,seis}$	HST3 / HST3-BW [kN]	2,0	6,9	11,9	16,0	20,7	-
	HST3-R / HST3-R-BW	2,3	6,9	11,9	16,0	20,7	-
Shear $V_{Rd,seis}$	HST3 / HST3-BW [kN]	7,9	15,2	22,9	38,8	66,3	-
	HST3-R / HST3-R-BW	7,9	13,8	22,1	34,0	53,9	-

Characteristic resistance in case of seismic performance C1

Anchor size		M8	M10	M12	M16	M20	M24
Tension $N_{Rk,seis}$	HST3 / HST3-BW [kN]	7,5	12,0	17,9	24,0	31,1	-
	HST3-R / HST3-R-BW	7,5	12,0	17,9	24,0	31,1	-
Shear $V_{Rk,seis}$	HST3 / HST3-BW [kN]	16,6	25,8	39,0	60,9	99,4	-
	HST3-R / HST3-R-BW	19,5	28,4	44,3	70,2	99,4	-

Design resistance in case of seismic performance C1

Anchor size		M8	M10	M12	M16	M20	M24
Tension $N_{Rd,seis}$	HST3 / HST3-BW [kN]	5,0	8,0	11,9	16,0	20,7	-
	HST3-R / HST3-R-BW	5,0	8,0	11,9	16,0	20,7	-
Shear $V_{Rd,seis}$	HST3 / HST3-BW [kN]	13,3	20,6	31,2	48,7	66,3	-
	HST3-R / HST3-R-BW	15,6	22,7	33,2	54,5	66,3	-

Fire resistance

All data in this section applies to:

- Correct setting (See setting instruction)
- No edge distance and spacing influence
- Steel failure
- Minimum base material thickness
- Concrete C 20/25, $f_{ck,cube} = 25 \text{ N/mm}^2$
- Hilti technical data for concrete strength class C55/67 to C80/95: for a structural element that fullfills the requirements according to DIN EN 1992-1-2 the fire resistance of C20/25 could be assumed.
- partial safety factor for resistance under fire exposure $\gamma_{M,fi}=1,0$ (in absence of other national regulations)

Effective anchorage depth for static

Anchor size		M8	M10	M12	M16	M20	M24			
Eff. Anchorage depth	h_{ef} [mm]	47	40	60	50	70	65	85	101	125

Characteristic resistance

Anchor size		M8	M10	M12	M16	M20	M24			
Fire Exposure R30										
Tension $N_{Rk,fi}$	HST3/HST3-BW [kN]	0,9	1,5	2,4	2,3	5,0	4,4	7,1	9,1	12,6
	HST3-R/HST3-R-BW	1,9	1,8	3,0	3,2	5,0	4,7	7,1	9,1	12,6
Shear $V_{Rk,fi}$	HST3/HST3-BW [kN]	0,9	1,5	2,4	2,3	5,2	4,4	9,7	15,2	21,9
	HST3-R/HST3-R-BW	4,9	4,7	11,8	8,9	17,1	16,9	31,9	37,0	62,8
Fire Exposure R120										
Tension $N_{Rk,fi}$	HST3/HST3-BW [kN]	0,6	0,8	0,9	0,8	1,3	1,5	2,4	3,8	5,4
	HST3-R/HST3-R-BW	1,5	1,5	2,4	2,5	4,0	3,8	5,6	7,3	10,1
Shear $V_{Rk,fi}$	HST3/HST3-BW [kN]	0,6	0,8	0,9	0,8	1,5	1,5	2,4	3,8	5,4
	HST3-R/HST3-R-BW	1,7	2,0	3,3	3,3	4,8	6,2	9,0	14,1	20,3

Design resistance

Anchor size		M8	M10	M12	M16	M20	M24			
Fire Exposure R30										
Tension $N_{Rd,fi}$	HST3/HST3-BW	0,9	1,5	2,4	2,3	5,0	4,4	7,1	9,1	12,6
	HST3-R/HST3-R-BW	1,9	1,8	3,0	3,2	5,0	4,7	7,1	9,1	12,6
Shear $V_{Rd,fi}$	HST3/HST3-BW	0,9	1,5	2,4	2,3	5,2	4,4	9,7	15,2	21,9
	HST3-R/HST3-R-BW	4,9	4,7	11,8	8,9	17,1	16,9	31,9	37,0	62,8
Fire Exposure R120										
Tension $N_{Rd,fi}$	HST3/HST3-BW	0,6	0,8	0,9	0,8	1,3	1,5	2,4	3,8	5,4
	HST3-R/HST3-R-BW	1,5	1,5	2,4	2,5	4,0	3,8	5,6	7,3	10,1
Shear $V_{Rd,fi}$	HST3/HST3-BW	0,6	0,8	0,9	0,8	1,5	1,5	2,4	3,8	5,4
	HST3-R/HST3-R-BW	1,7	2,0	3,3	3,3	4,8	6,2	9,0	14,1	20,3

Materials

Mechanical properties

Anchor size		M8	M10	M12	M16	M20	M24
Nominal tensile strength $f_{uk,thread}$	HST3/HST3-BW	800	800	800	720	700	530
	HST3-R/HST3-R-BW	720	710	710	650	650	650
Yield strength $f_{yk,thread}$	HST3/HST3-BW	640	640	640	576	560	450
	HST3-R/HST3-R-BW	576	568	568	520	520	500
Stressed cross-section A_s	[mm ²]	36,6	58,0	84,3	157	245	353
Moment of resistance W	[mm ³]	31,2	62,3	109	277	541	935
Char. bending resistance $M^{0}_{Rk,s}$	HST3/HST3-BW	30	60	105	240	457	595
	HST3-R/HST3-R-BW	27	53	93	216	425	730

Material quality

Part	Material	
Expansion sleeve	HST3/HST3-BW	M10, M16: Galvanized or Stainless steel M8, M12, M20, M24: Stainless steel
	HST3-R/HST3-R-BW	Stainless steel A4
Bolt	HST3/HST3-BW	Carbon steel, galvanized, coated (transparent)
	HST3-R/HST3-R-BW	Stainless steel A4, cone coated (transparent)
Washer	HST3/HST3-BW	Galvanized
	HST3-R/HST3-R-BW	Stainless steel A4
Hexagon nut	HST3/HST3-BW	Strength class 8
	HST3-R/HST3-R-BW	Stainless steel A4, coated

Anchor dimensions of HST3, HST3-BW, HST3-R, HST3-R-BW

Anchor size		M8	M10	M12	M16	M20	M24
Maximum length of anchor	$l_{max} \leq$ [mm]	260	280	350	475	450	500
Shaft diameter at the cone	d_R [mm]	5,60	6,94	8,22	11,00	14,62	17,4
Length of expansion sleeve	l_s [mm]	13,6	16,0	20,0	25,0	28,3	36,0
Diameter of washer	$d_w \geq$ [mm]	15,57	19,48	23,48	29,48	36,38	43,38

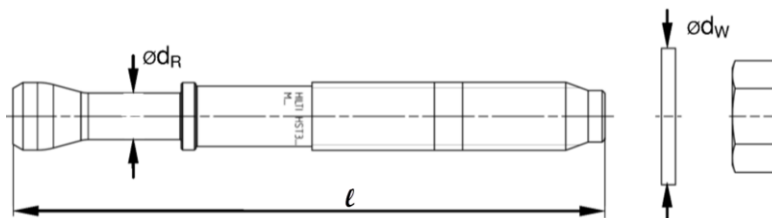

Setting information

Setting details

Anchor size		M8	M10	M12	M16	M20	M24
Nominal diameter of drill bit	d_o [mm]	8	10	12	16	20	24
Cutting diameter of drill bit	$d_{cut} \leq$ [mm]	8,45	10,45	12,5	16,5	20,55	24,55
Effective embedment depth	$h_{ef,1}$ [mm]	-	40	50	65	-	-
	$h_{ef,2}$ [mm]	47	60	70	85	101	125
Drill hole depth ¹⁾	$h_{1,1} \geq$ [mm]	-	53	68	86	-	-
	$h_{1,2} \geq$	59	73	88	106	124	151
Thread engagement length	$h_{nom,1}$ [mm]	-	48	60	78	-	-
	$h_{nom,2}$ [mm]	54	68	80	98	116	143
Maximum diameter of clearance hole in the fixture	d_f [mm]	9	12	14	18	22	26
Torque moment	T_{inst} [Nm]	20	45	60	110	180	300
Maximum thickness of fixture	$t_{fix,max}$ [mm]	195	220	270	370	310	330
Width across	SW [mm]	13	17	19	24	30	36

1) In case of diamond drilling +5 mm for M8 to M10 and +2 mm for M12 to M24.

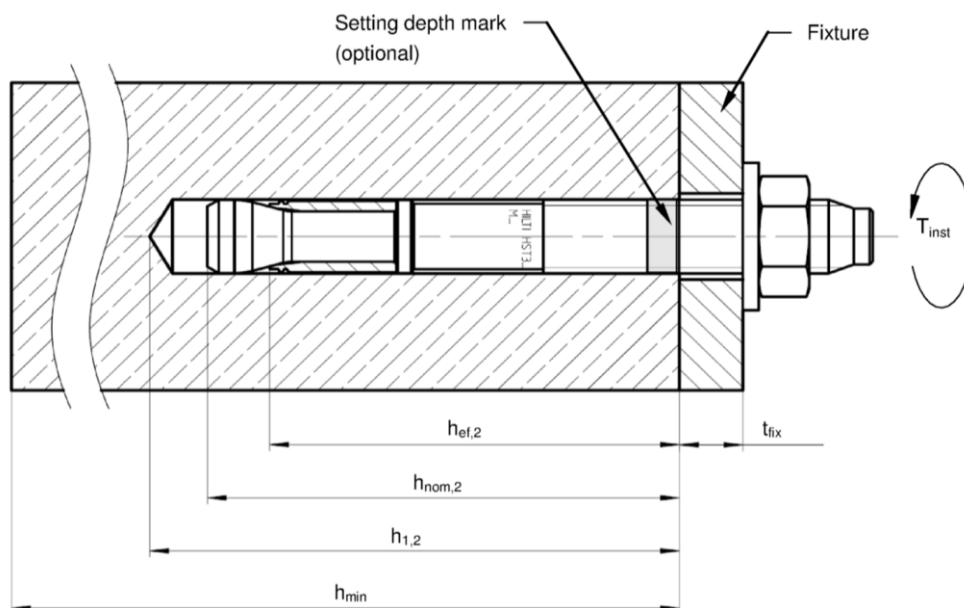

Installation equipment

Anchor size	M8	M10	M12	M16	M20	M24
Rotary hammer	TE2(-A) – TE30(-A)				TE40 – TE80	
Diamond coring tool	DD-30W, DD-EC1					
Setting tool	Hilti S7W 6AT 22A – SI-AT-A22			-		
Hollow drill bit	-		TE-CD, TE-YD			
Other tools	hammer, torque wrench, blow out pump					

Setting parameters of HST3 / HST3-R for M8 and M10

Anchor Size			M8			M10		
Concrete class			C20/25 to C50/60 ^{a)} C55/67 to C80/95 ^{b)}	C12/15 ^{b)} C16/20 ^{b)}	C12/15 to C16/20 ^{a)}	C20/25 to C50/60 ^{a)} C55/67 to C80/95 ^{b)}	C12/15 ^{b)} C16/20 ^{b)}	
Effective anchorage depth	h_{ef}	[mm]	47		47	40	60	60
Minimum base material thickness	h_{min}	[mm]	80	100	100	80	100	120
Minimum spacing in <i>non-cracked</i> concrete	s_{min}	[mm]	35	35	35	50	40	40
	for $c \geq$	[mm]	55	50	65	95	100	60
Minimum spacing in <i>cracked</i> concrete	s_{min}	[mm]	35	35	35	40	40	40
	for $c \geq$	[mm]	50	50	55	90	100	55
Minimum edge distance in <i>non-cracked</i> concrete	c_{min}	[mm]	40	40	50	50	60	50
	for $s \geq$	[mm]	50	50	80	190	90	90
Minimum edge distance in <i>cracked</i> concrete	c_{min}	[mm]	40	40	40	45	60	45
	for $s \geq$	[mm]	50	50	75	180	90	80
Critical spacing for splitting failure and concrete cone failure	$s_{cr,sp}$	[mm]	141		188	168	180	
	$s_{cr,N}$	[mm]	141		141	120	180	
Critical edge distance for splitting failure and concrete cone failure	$c_{cr,sp}$	[mm]	71		94	84	90	
	$c_{cr,N}$	[mm]	71		71	60	90	

Setting parameters of HST3 / HST3-R for M12 and M16

Anchor Size			M12			M16			
Concrete class			C20/25 to C50/60 ^{a)}	C20/25 to C50/60 ^{a)} C55/67 to C80/95 ^{b)}	C12/15 ^{b)} C16/20 ^{b)}	C20/25 to C50/20 ^{a)}	C20/25 to C50/60 ^{a)} C55/67 to C80/95 ^{b)}	C12/15 ^{b)} C16/20 ^{b)}	
Effective anchorage	h_{ef}	[mm]	50	70		70	65	85	
Minimum base material	h_{min}	[mm]	100	120	140	140	120	140	
Minimum spacing in <i>non-cracked</i> concrete	s_{min}	[mm]	55	50	60	110	75	80	
	for c	[mm]	110	100	70	140	140	130	
Minimum spacing in <i>cracked</i> concrete	s_{min}	[mm]	50	50	50	80	65	80	
	for $c \geq$	[mm]	105	90	70	120	130	130	
Minimum edge distance in <i>non-cracked</i> concrete	c_{min}	[mm]	60	60	55	90	65	65	
	for $s \geq$	[mm]	210	120	110	190	240	180	
Minimum edge distance in <i>cracked</i> concrete	c_{min}	[mm]	55	60	55	80	65	65	
	for $s \geq$	[mm]	210	120	110	170	240	180	
Critical spacing for splitting failure and concrete cone failure	$s_{cr,sp}$	[mm]	180	210		280	208	255	
	$s_{cr,N}$	[mm]	150	210		210	195	255	
Critical edge distance for splitting failure and concrete cone failure	$c_{cr,sp}$	[mm]	90	105		140	104	128	
	$c_{cr,N}$	[mm]	75	105		105	98	128	

Setting parameters of HST3(-BW) / HST3-R(-BW) for M20 and M24

Anchor Size		M20			M24		
Concrete class		C20/25 to C50/60 ^{a)} C55/67 to C80/95 ^{b)}		C12/15 ^{b)} C16/20 ^{b)}	C20/25 to C50/60 ^{a)} C55/67 to C80/95 ^{b)}	C12/15 ^{b)} C16/20 ^{b)}	
Effective anchorage	h_{ef} [mm]	101		101	125	125	
Minimum base material	h_{min} [mm]	160	200	200	250	250	
Minimum spacing in <i>non-cracked</i> concrete	HST3	s_{min} [mm]	120	90	90	125	180
	HST3-BW	for $c \geq$ [mm]	180	130	165	255	375
Minimum spacing in <i>cracked</i> concrete	HST3-R	s_{min} [mm]	120	90	90	125	180
	HST3-R-BW	for $c \geq$ [mm]	180	130	165	205	375
Min. edge distance in <i>non-cracked</i> concrete	HST3	c_{min} [mm]	120	80	90	170	260
	HST3-BW	for $s \geq$ [mm]	180	180	140	295	400
Min. edge distance in <i>cracked</i> concrete	HST3-R	c_{min} [mm]	120	80	120	150	260
	HST3-R-BW	for $s \geq$ [mm]	180	180	270	235	400
Critical spacing for splitting failure and concrete cone failure	HST3	$s_{cr,sp}$ [mm]	384		404	375	500
	HST3-BW	$s_{cr,N}$ [mm]	303		303	375	375
Critical spacing for splitting failure and concrete cone failure	HST3-R	$s_{cr,sp}$ [mm]	192		202	188	250
	HST3-R-BW	$s_{cr,N}$ [mm]	152		152	188	188

a) Data covered by ETA-98/0001 issue 2017-20-07.

b) Data covered by Hilti Technical Data

For spacing (edge distance) smaller than critical spacing (critical edge distance) the design loads have to be reduced.

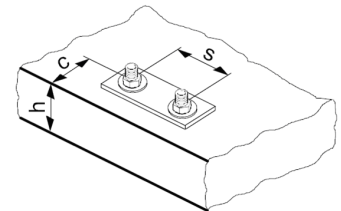

Setting instructions

*For detailed information on installation see instruction for use given with the package of the product

Setting instruction for HST3, HST3-BW, HST3-R, HST3-R-BW

Hammer drilling (M8, M10, M12, M16, M20, M24)

1. Drill the hole

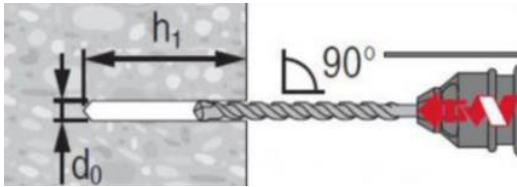

2. Clean the hole

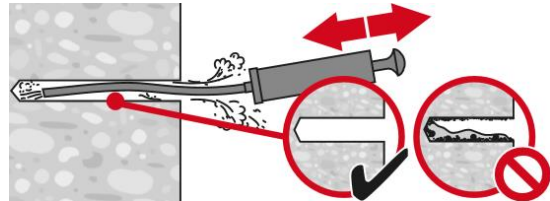

3a. Insert the anchor with hammer

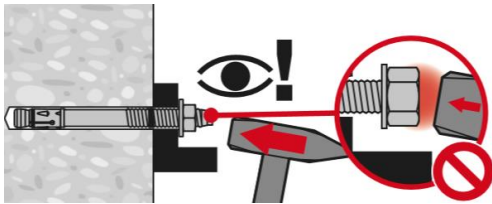

3a. Insert the anchor with setting tool HS-SC

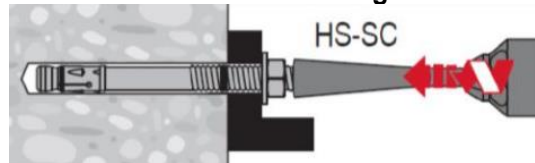

4. Check

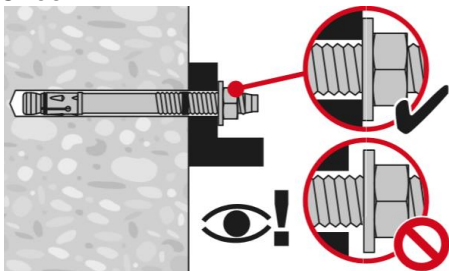

5a. Torque with calibrated torque wrench (M8-M24)

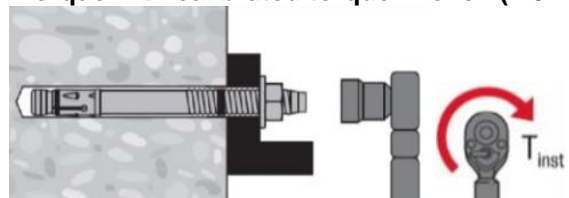

5b. Torque with impact wrench with Adaptive torque module (M8-M12)

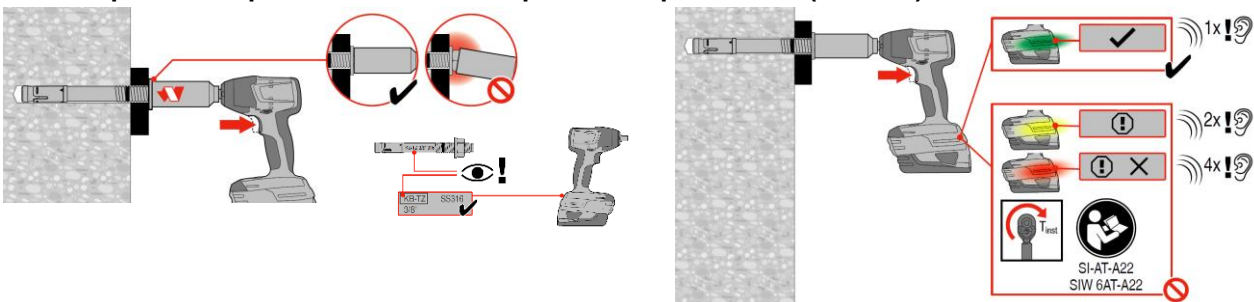

Hollow Drill Bit (M16, M20, M24), no cleaning required

1. Drill the hole with the Hollow drill bit

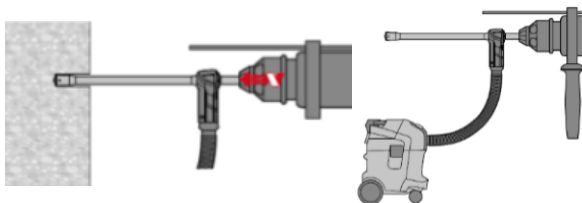

2a. Insert the anchor with hammer

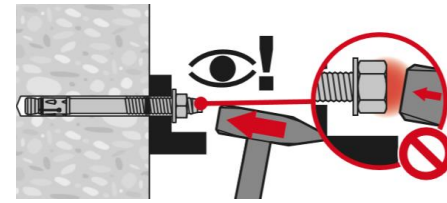

2b. Insert the anchor with setting tool HS-SC

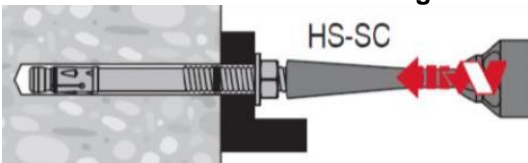

3. Check

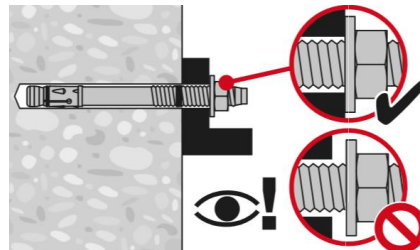

5a. Torque with calibrated torque wrench (M8-M24)

5b. Torque with impact wrench with Adaptive torque module (M8-M12)

Diamond coring (M8, M10, M12, M16, M20, M24)

1. Core the hole

2. Flushing

3. Clean the hole

4a. Insert the anchor with hammer

4b. Use a setting tool HS-SC

5. Check

6a. Torque with calibrated torque wrench (M8-M24)

6b. Torque with impact wrench with Adaptive torque module (M8-M12)

Chemical anchors

Expansion

Mechanical anchors

Plastic/Light duty metal anchors

Insulation anchors

HST2 Expansion anchor

Everyday standard expansion anchor for cracked concrete

Anchor version



HST2
HST2-R
(M8-M16)



HST2-BW
HST2-R-BW
(M8-M16)

Benefits

- Optimized expansion cone and wedge design combined with special steel and coatings.
- Suitable for non-cracked and cracked concrete
- Product and length identification mark facilitates quality control and inspection

Base material



Concrete
(non-cracked)

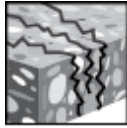

Concrete
(cracked)

Load conditions

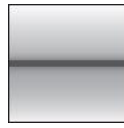

Static/
quasi-static



Fire
resistance



Seismic
ETA-C1, C2

Installation conditions



Hammer
drilled holes



Diamond
drilled holes

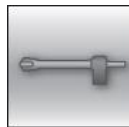

Hollow drill-
bit drilling



Impact wrench
with adaptative
torque module



European
Technical
Assessment



CE
conformity



PROFIS
Anchor design
Software



FM
approved

Approvals / certificates

Description	Authority / Laboratory	No. / date of issue
European technical assessment ^{a)}	DIBt, Berlin	ETA-15/0435 / 2017-12-21
Fire test report	DIBt, Berlin	ETA-15/0435 / 2017-12-21

a) All data given in this section according to ETA-15/0435, issue 2017-12-21.

Static and quasi-static loading (for a single anchor)

All data in this section applies to:

- Correct setting (See setting instruction)
- No edge distance and spacing influence
- Steel failure
- Minimum base material thickness
- Concrete C 20/25, $f_{ck,cube} = 25 \text{ N/mm}^2$

Effective anchorage depth for static

Anchor size		M8	M10	M12	M16
Eff. Anchorage depth	h_{ef} [mm]	47	60	70	82

Mean ultimate resistance

Anchor size		M8	M10	M12	M16	
Non-cracked concrete						
Tension $N_{Ru,m}$	HST2/HST2-BW	[kN]	11,9	21,2	26,6	46,5
	HST2-R/HST2-R-BW		11,9	21,2	26,6	46,5
Shear $V_{Ru,m}$	HST2/HST2-BW	[kN]	12,0	22,7	33,0	58,1
	HST2-R/HST2-R-BW		16,5	26,6	38,5	66,8
Cracked concrete						
Tension $N_{Ru,m}$	HST2/HST2-BW	[kN]	6,6	11,9	15,9	26,6
	HST2-R/HST2-R-BW		6,6	11,9	15,9	33,2
Shear $V_{Ru,m}$	HST2/HST2-BW	[kN]	12,0	22,7	33,0	58,1
	HST2-R/HST2-R-BW		16,5	26,6	38,5	66,8

Characteristic resistance

Anchor size		M8	M10	M12	M16	
Non-cracked concrete						
Tension N_{Rk}	HST2/HST2-BW	[kN]	9,0	16,0	20,0	35,0
	HST2-R/HST2-R-BW		9,0	16,0	20,0	35,0
Shear V_{Rk}	HST2/HST2-BW	[kN]	11,4	21,6	31,4	55,3
	HST2-R/HST2-R-BW		15,7	25,3	36,7	63,6
Cracked concrete						
Tension N_{Rk}	HST2/HST2-BW	[kN]	5,0	9,0	12,0	20,0
	HST2-R/HST2-R-BW		5,0	9,0	12,0	25,0
Shear V_{Rk}	HST2/HST2-BW	[kN]	11,4	21,6	31,4	55,3
	HST2-R/HST2-R-BW		15,7	25,3	36,7	63,6

Design resistance

Anchor size			M8	M10	M12	M16
Non-cracked concrete						
Tension N_{Rd}	HST2/HST2-BW	[kN]	6,0	10,7	13,3	23,3
	HST2-R/HST2-R-BW		6,0	10,7	13,3	23,3
Shear V_{Rd}	HST2/HST2-BW	[kN]	9,1	17,3	25,1	44,2
	HST2-R/HST2-R-BW		12,6	20,2	29,4	50,9
Cracked concrete						
Tension N_{Rd}	HST2/HST2-BW	[kN]	3,3	6,0	8,0	13,3
	HST2-R/HST2-R-BW		3,3	6,0	8,0	16,7
Shear V_{Rd}	HST2/HST2-BW	[kN]	9,1	17,3	25,1	44,2
	HST2-R/HST2-R-BW		12,6	20,2	29,4	44,6

Recommended loads ^{a)}

Anchor size			M8	M10	M12	M16
Non-cracked concrete						
Tension N_{rec}	HST2/HST2-BW	[kN]	4,3	7,6	9,5	16,7
	HST2-R/HST2-R-BW		4,3	7,6	9,5	16,7
Shear V_{rec}	HST2/HST2-BW	[kN]	6,5	12,3	17,9	31,6
	HST2-R/HST2-R-BW		9,0	14,5	21,0	35,7
Cracked concrete						
Tension N_{rec}	HST2/HST2-BW	[kN]	2,4	4,3	5,7	9,5
	HST2-R/HST2-R-BW		2,4	4,3	5,7	11,9
Shear V_{rec}	HST2/HST2-BW	[kN]	6,5	12,3	17,9	31,6
	HST2-R/HST2-R-BW		9,0	14,5	21,0	31,8

a) With overall partial safety factor for action $\gamma = 1,4$, The partial safety factors for action depend on the type of loading and shall be taken from national regulations,

Seismic loading (for a single anchor)

All data in this section applies to:

- Correct setting (See setting instruction)
- No edge distance and spacing influence
- Steel failure
- Minimum base material thickness
- Concrete C 20/25, $f_{ck,cube} = 25 \text{ N/mm}^2$
- $\alpha_{gap} = 1,0$ (using Hilti seismic filling set)

Effective anchorage depth for static

Anchor size		M10	M12	M16
Eff. Anchorage depth	h_{ef} [mm]	60	70	82

Characteristic resistance in case of seismic performance C2

Anchor size		M10	M12	M16
Tension				
$N_{Rk,seis}$	HST2/HST2-BW [kN]	3,3	10,0	12,8
Shear				
$V_{Rk,seis}$	HST2/HST2-BW [kN]	16,0	24,2	41,3

Design resistance in case of seismic performance C2

Anchor size		M10	M12	M16
Tension				
$N_{Rd,seis}$	HST2/HST2-BW [kN]	2,2	6,7	8,5
Shear				
$V_{Rd,seis}$	HST2/HST2-BW [kN]	12,8	19,4	33,0

Characteristic resistance in case of seismic performance C1

Anchor size		M10	M12	M16
Tension				
$N_{Rk,seis}$	HST2/HST2-BW [kN]	8,0	10,7	18,0
Shear				
$V_{Rk,seis}$	HST2/HST2-BW [kN]	16,0	27,0	41,3

Design resistance in case of seismic performance C1

Anchor size		M10	M12	M16
Tension				
$N_{Rd,seis}$	HST2/HST2-BW [kN]	5,3	7,1	12,0
Shear				
$V_{Rd,seis}$	HST2/HST2-BW [kN]	12,8	21,6	33,0

Fire resistance

All data in this section applies to:

- Correct setting (See setting instruction)
- No edge distance and spacing influence
- Steel failure
- Minimum base material thickness
- Concrete C 20/25, $f_{ck,cube} = 25 \text{ N/mm}^2$
- Hilti technical data for concrete strength class C55/67 to C80/95: for a structural element that fulfills the requirements according to DIN EN 1992-1-2 the fire resistance of C20/25 could be assumed.
- partial safety factor for resistance under fire exposure $\gamma_{M,fi}=1,0$ (in absence of other national regulations)

Effective anchorage depth for static

Anchor size	M8	M10	M12	M16
Eff. Anchorage depth h_{ef} [mm]	47	60	70	82

Characteristic resistance

Anchor size	M8	M10	M12	M16	
Fire Exposure R30					
Tension $N_{Rk,fi}$	HST2/HST2-BW [kN]	0,9	2,3	3,0	5,0
	HST2-R/HST2-R-BW	0,9	2,3	3,0	5,0
Shear $V_{Rk,fi}$	HST2/HST2-BW [kN]	0,9	2,5	5,0	9,0
	HST2-R/HST2-R-BW	0,9	2,5	5,0	9,0
Fire Exposure R120					
Tension $N_{Rk,fi}$	HST2/HST2-BW [kN]	0,5	0,7	1,0	2,0
	HST2-R/HST2-R-BW	0,5	0,7	1,0	2,0
Shear $V_{Rk,fi}$	HST2/HST2-BW [kN]	0,5	0,7	1,0	2,0
	HST2-R/HST2-R-BW	0,5	0,7	1,0	2,0

Design resistance

Anchor size	M8	M10	M12	M16	
Fire Exposure R30					
Tension $N_{Rd,fi}$	HST2/HST2-BW [kN]	0,9	2,3	3,0	5,0
	HST2-R/HST2-R-BW	0,9	2,3	3,0	5,0
Shear $V_{Rd,fi}$	HST2/HST2-BW [kN]	0,9	2,5	5,0	9,0
	HST2-R/HST2-R-BW	0,9	2,5	5,0	9,0
Fire Exposure R120					
Tension $N_{Rd,fi}$	HST2/HST2-BW [kN]	0,5	0,7	1,0	2,0
	HST2-R/HST2-R-BW	0,5	0,7	1,0	2,0
Shear $V_{Rd,fi}$	HST2/HST2-BW [kN]	0,5	0,7	1,0	2,0
	HST2-R/HST2-R-BW	0,5	0,7	1,0	2,0

Materials

Mechanical properties

Anchor size		M8	M10	M12	M16
Nominal tensile strength $f_{uk,thread}$	HST2/HST2-BW [N/mm ²]	660	730	710	720
	HST2-R/HST2-R-BW	720	710	710	650
Yield strength $f_{yk,thread}$	HST2/HST2-BW [N/mm ²]	528	584	568	576
	HST2-R/HST2-R-BW	576	568	568	520
Stressed cross-section A_s	[mm ²]	36,6	58,0	84,3	157
Moment of resistance W	[mm ³]	31,2	62,3	109	277
Char, bending resistance $M^0_{Rk,s}$	HST2/HST2-BW [Nm]	25	55	93	240
	HST2-R/HST2-R-BW	27	53	93	216

Material quality

Part	Material	
Bolt	HST2/HST2-BW	Carbon steel, galvanized
	HST2-R/HST2-R-BW	Stainless steel

Anchor dimensions

Anchor size		M8	M10	M12	M16
Minimum thickness of fixture	$t_{fix,min}$ [mm]	2	2	2	2
Maximum thickness of fixture	$t_{fix,max}$ [mm]	195	200	200	235
Shaft diameter at the cone	d_R [mm]	5,5	7,2	8,5	11,6
Maximum length of anchor	$l_{1,max}$ [mm]	75	90	105	140
Minimum length of anchor	$l_{1,min}$ [mm]	260	280	295	350
Length of expansion sleeve	l_2 [mm]	14,8	18,2	22,7	24,3

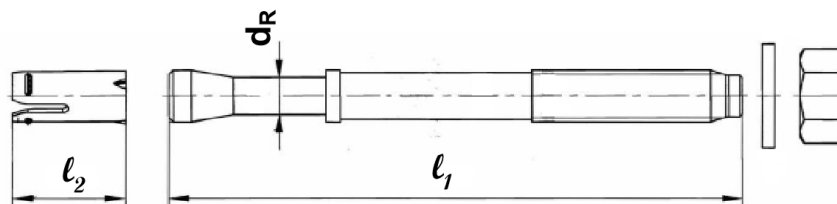

Setting information

Setting details

Anchor size		M8	M10	M12	M16
Nominal diameter of drill bit	d_o [mm]	8	10	12	16
Cutting diameter of drill bit	$d_{cut} \leq$ [mm]	8,45	10,45	12,50	16,50
Drill hole depth ¹⁾	$h_{1,1} \geq$ [mm]	60	74	88	103
	$h_{1,2} \geq$ [mm]	65	75	90	105
Diameter of clearance hole in the fixture	d_f [mm]	9	12	14	18
Torque moment	T_{inst} [Nm]	20	45	60	110
Width across	SW [mm]	13	17	19	24

1) $h_{1,1}$ valid for hammer drilled holes and $h_{1,2}$ valid for diamond drilled holes.

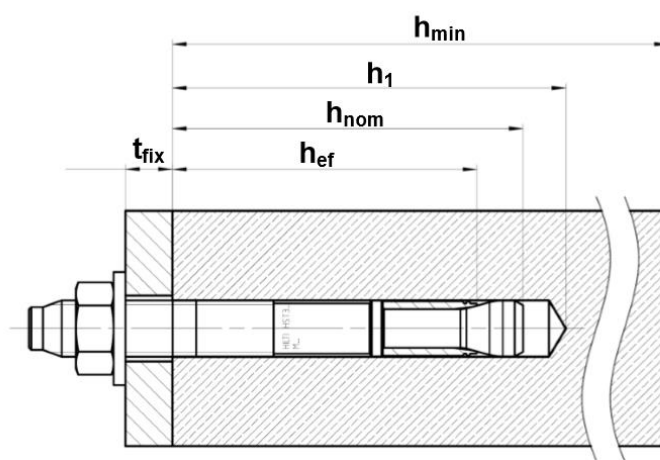

Installation equipment

Anchor size	M8	M10	M12	M16
Rotary hammer	TE2 – TE16			
Diamond coring tool	DD – 30W, DD – EC1			
Hollow drill bit	-	-	TE – CD, TE – YD	
Other tools	hammer, torque wrench, blow ut pump			

Setting parameters

Anchor Size			M8		M10		M12		M16		
Effective anchorage depth	h_{ef}	[mm]	47		60		70		82		
Minimum base material thickness	h_{min}	[mm]	100	800	120	100	140	120	160	140	
Minimum spacing in <i>non-cracked</i> concrete	HST2/HST2-BW	s_{min}	[mm]	60	60	55	55	60	60	70	80
		for $c \geq$	[mm]	50	75	80	115	85	100	110	140
	HST2/HST2-BW	s_{min}	[mm]	60	60	55	55	60	60	70	80
		for $c \geq$	[mm]	60	75	70	115	80	100	110	140
Minimum spacing in <i>cracked</i> concrete	HST2/HST2-BW	s_{min}	[mm]	40	50	55	55	60	60	70	80
		for $c \geq$	[mm]	50	60	70	110	75	100	100	140
	HST2/HST2-BW	s_{min}	[mm]	40	50	55	55	60	60	70	80
		for $c \geq$	[mm]	50	60	65	110	75	100	100	140
Minimum edge distance in <i>non-cracked</i> concrete	HST2/HST2-BW	c_{min}	[mm]	50	70	55	70	55	70	85	80
		for $s \geq$	[mm]	60	80	115	110	145	130	160	180
	HST2/HST2-BW	c_{min}	[mm]	60	70	50	70	55	70	70	80
		for $c \geq$	[mm]	60	80	115	110	145	130	160	180
Minimum edge distance in <i>cracked</i> concrete	HST2/HST2-BW	c_{min}	[mm]	45	55	55	70	55	70	70	80
		for $s \geq$	[mm]	50	60	90	100	120	130	150	180
	HST2/HST2-BW	c_{min}	[mm]	45	55	50	70	55	70	60	80
		for $c \geq$	[mm]	50	60	90	100	110	130	160	180
Critical spacing for splitting failure and concrete cone failure	$s_{cr,sp}$	[mm]	141		180		210		246		
	$s_{cr,N}$	[mm]	141		180		210		246		
Critical spacing for splitting failure and concrete cone failure	$c_{cr,sp}$	[mm]	71		90		105		123		
	$c_{cr,N}$	[mm]	71		90		105		123		

For spacing (edge distance) smaller than critical spacing (critical edge distance) the design loads have to be reduced.

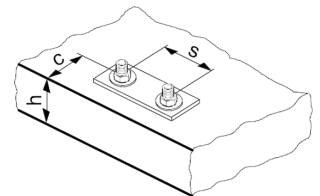

Setting instructions

*For detailed information on installation see instruction for use given with the package of the product

Setting instruction

Hammer drilling

1. Drill the hole

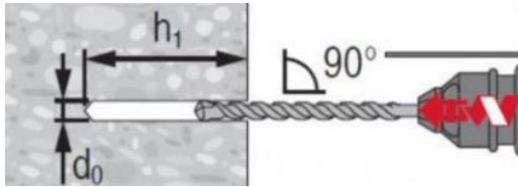

2. Clean the hole

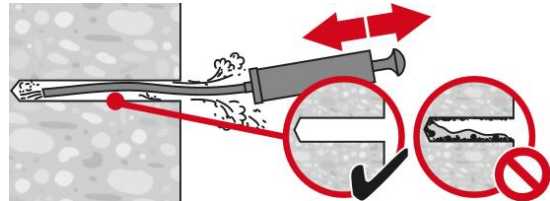

3a. Insert the anchor with hammer

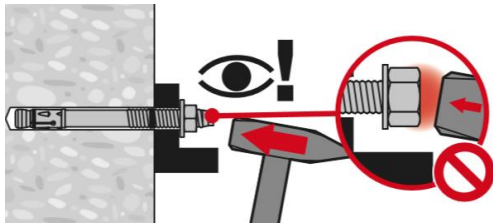

3a. Insert the anchor with setting tool HS-SC (M8-M16)

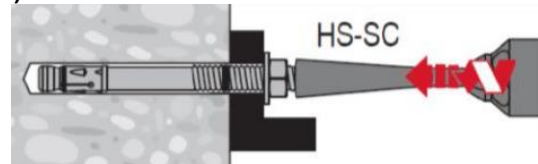

4. Check

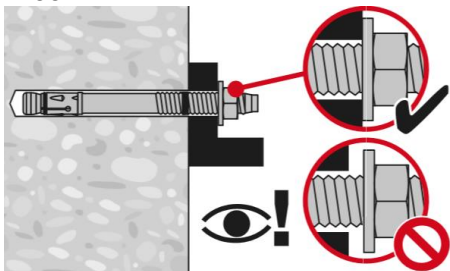

5a. Torque with calibrated torque wrench (M8-M24)

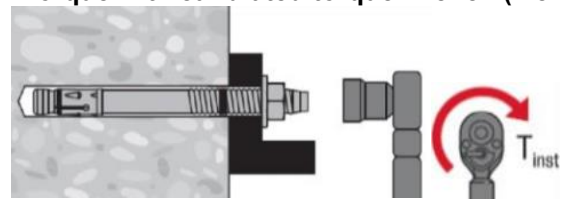

5b. Torque with impact wrench with Adaptive torque module (M8-M12)

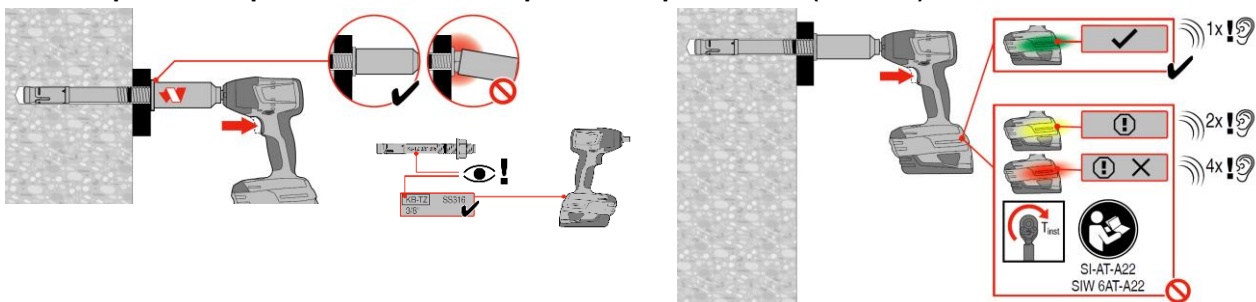

Hollow Drill Bit, no cleaning required

1. Drill the hole with the Hollow drill bit

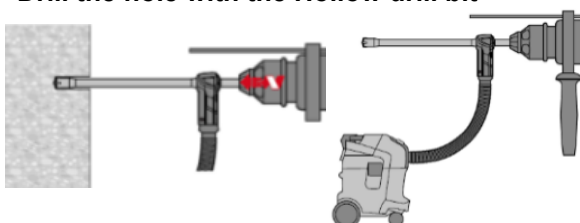

2a. Insert the anchor with hammer

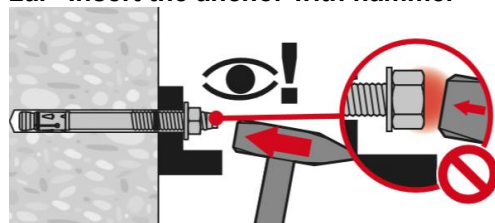

2a. Insert the anchor with setting tool HS-SC

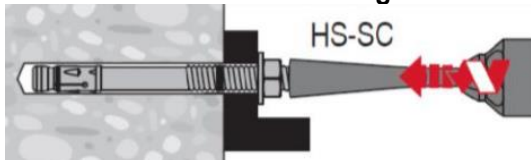

3. Check

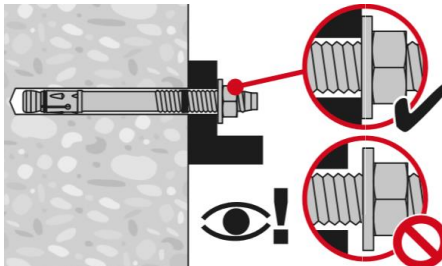

4a. Torque with calibrated torque wrench (M8-M24)

4b. Torque with impact wrench with Adaptive torque module (M8-M12)

Diamond coring

1. Core the hole

2. Flushing

3. Clean the hole

4a. Insert the anchor with hammer

4b. Insert the anchor with setting tool HS-SC (M8-M16)

5. Check

6a. Torque with calibrated torque wrench (M8-M24)

6b. Torque with impact wrench with Adaptive torque module (M8-M12)

Chemical anchors
Expansion
Mechanical anchors
Plastic/Light duty metal anchors
Insulation anchors

HSA Expansion anchor

Everyday standard expansion anchor for uncracked concrete

Chemical anchors

Expansion

Mechanical anchors

Plastic/Light duty metal anchors

Insulation anchors

Anchor version



HSA
HSA-F
HSA-R
HSA-R2
(M6-M20)



HSA-BW
(M6-M20)

Benefits

- Fast & convenient setting behaviour
- Reliable ETA approved torquing using impact wrench with torque bar for torque control
- Small edge and spacing distances
- High loads
- Three embedment depths for maximal design flexibility
- M12, M16 and M20 ETA approved for diamond cored holes using DD 30-W and matching diamond core bit
- Suitable for pre- and through fastening
- Long lengths available suitable for wood structures fastening applications

Base material



Concrete
(non-cracked)

Load conditions

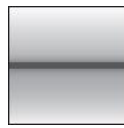

Static/
quasi-static

Installation conditions

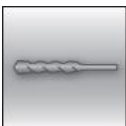

Hammer
drilled holes



Diamond
drilled holes

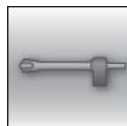

Hollow drill-
bit drilling

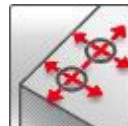

Small edge
distance and
spacing

Other information



European
Technical
Assessment



CE
conformity



PROFIS
Anchor
design
Software



Corrosion
resistance

Approvals / certificates

Description	Authority / Laboratory	No. / date of issue
European technical assessment ^{a)}	DIBt, Berlin	ETA-11/0374 / 2016-08-08

a) All data given in this section according to ETA-11/0374, issue 2016-08-08.

Static and quasi-static loading (for a single anchor)

All data in this section applies to:

- Correct setting (See setting instruction)
- No edge distance and spacing influence
- **Steel** failure
- Minimum base material thickness
- Concrete C 20/25, $f_{ck,cube} = 25 \text{ N/mm}^2$

Effective anchorage depth

Anchor size			M6			M8			M10		
Eff. Anchorage depth	h_{ef}	[mm]	30	40	60	30	40	70	40	50	80
Anchor size			M12			M16			M20		
Eff. Anchorage depth	h_{ef}	[mm]	50	65	100	65	80	120	75	100	115

Characteristic resistance

Anchor size			M6			M8			M10		
Eff. Anchorage depth	h_{ef}	[mm]	30	40	60	30	40	70	40	50	80
Tension N_{Rk}	HSA, HSA-BW	[kN]	6,0	7,5	9,0	8,3	12,8	16,0	12,8	17,9	25,0
	HSA-R2, HSA-R		6,0	7,5	9,0	8,3	12,8	16,0	12,8	17,9	25,0
	HSA-F		6,0	7,5	9,0	8,3	12,8	15,9	12,8	17,9	25,0
Shear V_{Rk}	HSA, HSA-BW	[kN]	6,5	6,5	6,5	8,3	10,6	10,6	18,9	18,9	18,9
	HSA-R2, HSA-R		7,2	7,2	7,2	8,3	12,3	12,3	22,6	22,6	22,6
	HSA-F		6,5	6,5	6,5	8,3	10,6	10,6	18,9	18,9	18,9
Anchor size			M12			M16			M20		
Eff. Anchorage depth	h_{ef}	[mm]	50	65	100	65	80	120	75	100	115
Tension N_{Rk}	HSA, HSA-BW	[kN]	17,9	26,5	35,0	26,5	36,1	50,0	32,8	50,5	62,3
	HSA-R2, HSA-R		17,9	26,5	35,0	26,5	36,1	50,0	32,8	50,5	62,3
	HSA-F		17,9	26,5	35,0	26,5	36,1	50,0	32,8 ^{b)}	50,5 ^{b)}	62,3 ^{b)}
Shear V_{Rk}	HSA, HSA-BW	[kN]	29,5	29,5	29,5	51,0	51,0	51,0	65,6	85,8	85,8
	HSA-R2, HSA-R		29,3	29,3	29,3	56,5	56,5	56,5	65,6	91,9	91,9
	HSA-F		29,5	29,5	29,5	51,0	51,0	51,0	65,6 ^{b)}	85,8 ^{b)}	85,8 ^{b)}

b) Data covered by Hilti Technical Data.

Design resistance

Anchor size			M6			M8			M10		
Eff. Anchorage depth	h_{ef}	[mm]	30	40	60	30	40	70	40	50	80
Tension N_{Rd}	HSA, HSA-BW	[kN]	4,0	5,0	6,0	5,5	8,5	10,7	8,5	11,9	16,7
	HSA-R2, HSA-R		4,0	5,0	6,0	5,5	8,5	10,7	8,5	11,9	16,7
	HSA-F		4,0	5,0	6,0	5,5	8,5	10,7	8,5	11,9	16,7
Shear V_{Rd}	HSA, HSA-BW	[kN]	5,2	5,2	5,2	5,5	8,5	8,5	15,1	15,1	15,1
	HSA-R2, HSA-R		5,5	5,8	5,8	5,5	9,8	9,8	18,1	18,1	18,1
	HSA-F		5,2	5,2	5,2	5,5	8,5	8,5	15,1	15,1	15,1
Anchor size			M12			M16			M20		
Eff. Anchorage depth	h_{ef}	[mm]	50	65	100	65	80	120	75	100	115
Tension N_{Rd}	HSA, HSA-BW	[kN]	11,9	17,6	23,3	17,6	24,1	33,3	21,9	33,7	41,5
	HSA-R2, HSA-R		11,9	17,6	23,3	17,6	24,1	33,3	21,9	33,7	41,5
	HSA-F		11,9	17,6	23,3	17,6	24,1	33,3	21,9 ^{b)}	33,7 ^{b)}	41,5 ^{b)}
Shear V_{Rd}	HSA, HSA-BW	[kN]	23,6	23,6	23,6	40,8	40,8	40,8	43,7	68,6	68,6
	HSA-R2, HSA-R		23,4	23,4	23,4	45,2	45,2	45,2	43,7	73,5	73,5
	HSA-F		23,6	23,6	23,6	40,8	40,8	40,8	43,7 ^{b)}	68,6 ^{b)}	68,6 ^{b)}

b) Data covered by Hilti Technical Data.

Recommended loads ^{a)}

Anchor size		M6			M8			M10			
Eff. Anchorage depth h_{ef} [mm]		30	40	60	30	40	70	40	50	80	
Tension N_{rec}	HSA, HSA-BW	[kN]	2,9	3,6	4,3	4,0	6,1	7,6	6,1	8,5	11,9
	HSA-R2, HSA-R		2,9	3,6	4,3	4,0	6,1	7,6	6,1	8,5	11,9
	HSA-F		2,9	3,6	4,3	4,0	6,1	7,6	6,1	8,5	11,9
Shear V_{rec}	HSA, HSA-BW	[kN]	3,7	3,7	3,7	4,0	6,1	6,1	10,8	10,8	10,8
	HSA-R2, HSA-R		4,0	4,1	4,1	4,0	7,0	7,0	12,9	12,9	12,9
	HSA-F		3,7	3,7	3,7	4,0	6,1	6,1	10,8	10,8	10,8
Anchor size		M12			M16			M20			
Eff. Anchorage depth h_{ef} [mm]		50	65	100	65	80	120	75	100	115	
Tension N_{rec}	HSA, HSA-BW	[kN]	8,5	12,6	16,7	12,6	17,2	23,8	15,6	24,0	29,7
	HSA-R2, HSA-R		8,5	12,6	16,7	12,6	17,2	23,8	15,6	24,0	29,7
	HSA-F		8,5	12,6	16,7	12,6	17,2	23,8	15,6 ^{b)}	24,0 ^{b)}	29,7 ^{b)}
Shear V_{rec}	HSA, HSA-BW	[kN]	16,9	16,9	16,9	29,1	29,1	29,1	31,2	49,0	49,0
	HSA-R2, HSA-R		16,7	16,7	16,7	32,3	32,3	32,3	31,2	52,5	52,5
	HSA-F		16,9	16,9	16,9	29,1	29,1	29,1	31,2 ^{b)}	49,0 ^{b)}	49,0 ^{b)}

a) With overall partial safety factor for action $\gamma = 1,4$. The partial safety factors for action depend on the type of loading and shall be taken from national regulations.

b) Data covered by Hilti Technical data

Materials
Mechanical properties

Anchor size		M6	M8	M10	M12	M16	M20	
Nominal tensile strength $f_{uk,thread}$	HSA, HSA-BW, HSA-F	[N/mm ²]	650	580	650	700	650	700
	HSA-R2, HSA-R		650	560	650	580	600	625
Yield strength $f_{yk,thread}$	HSA, HSA-BW, HSA-F	[N/mm ²]	520	464	520	560	520	560
	HSA-R2, HSA-R		520	448	520	464	480	500
Stressed cross-section A_s		[mm ²]	20,1	36,6	58	84,3	157	245
Moment of resistance W		[mm ³]	12,7	31,2	62,3	109,2	277,5	540,9
Char. bending resistance	HSA, HSA-BW, HSA-F	[Nm]	9,9	21,7	48,6	91,7	216,4	454,4
	HSA-R2, HSA-R		9,9	21	48,6	76	199,8	405,7

Material quality

Part		Material
HSA HSA-BW (Carbon steel)	Bolt	Galvanized ($\geq 5 \mu\text{m}$)
	Sleeve	Galvanized ($\geq 5 \mu\text{m}$)
	Washer	Galvanized ($\geq 5 \mu\text{m}$)
	Hexagon nut	Strength class 8 / Galvanized ($\geq 5 \mu\text{m}$)
HSA-R2 (Stainless steel)	Bolt	Stainless steel A2, 1.4301; M6-M20 coated
	Sleeve	Stainless steel A2
	Washer	Stainless steel A2
	Hexagon nut	Stainless steel A2; / M6-M20 coated
HSA-R (Stainless steel)	Bolt	Stainless steel A4, 1.4401 or 1.4362 / M6-M20 coated
	Sleeve	Stainless steel A2
	Washer	Stainless steel A4
	Hexagon nut	Stainless steel A4; / M6-M20 coated
HSA-F (Carbon steel)	Bolt	Stainless steel A2 Hot-dip galvanized ($\geq 42 \mu\text{m}$)
	Sleeve	Stainless steel A2
	Washer	Hot-dip galvanized ($\geq 42 \mu\text{m}$)
	Hexagon nut	Strength class 8 / Hot-dip galvanized ($\geq 42 \mu\text{m}$)

Geometry washer

Anchor size		M6	M8	M10	M12	M16	M20
Inner diameter d_1							
HSA, HSA-R2, HSA-R, HSA-F	d_1 [mm]	6,4	8,4	10,5	13,0	17,0	21
HSA-BW	d_1 [mm]	6,4	8,4	10,5	13,0	17,0	22
Outer diameter d_2							
HSA, HSA-R2, HSA-R, HSA-F	d_2 [mm]	12,0	16,0	20,0	24,0	30,0	37,0
HSA-BW	d_2 [mm]	18,0	24,0	30,0	37,0	50,0	60,0
Thickness h							
HSA, HSA-R2, HSA-R, HSA-F	h [mm]	1,6	1,6	2,0	2,5	3,0	3,0
HSA-BW	h [mm]	1,8	2,0	2,5	3,0	3,0	4,0

Product marking and identification of anchor:

Beginning of thread: setting depth indicator for $h_{\text{nom},1}$

$h_{\text{nom},1}$ is reached when non-threaded part of the bolt is completely below the concrete surface

Blue ring: setting depth indicator for $h_{\text{nom},2}$

$h_{\text{nom},2}$ is reached when the blue ring is completely below the concrete surface

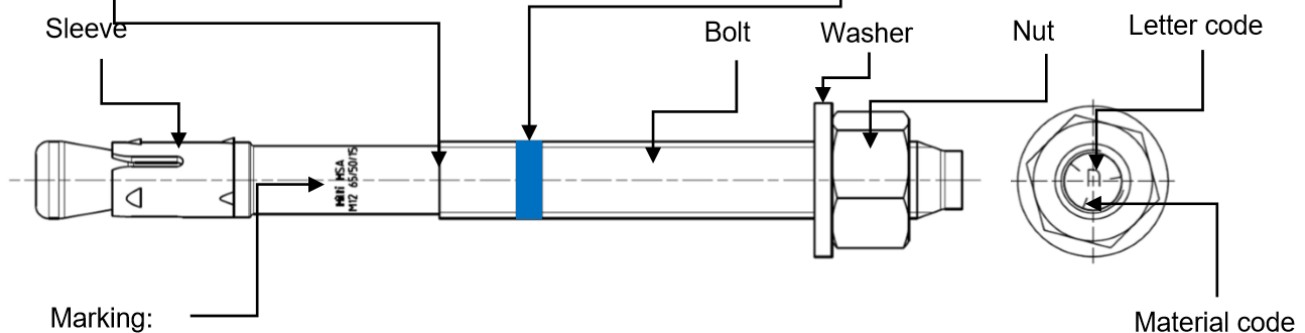

e.g.
 Hilti HSA ... Brand and Anchor type
 M12 65/50/15 ... Anchor Size and the max. $t_{\text{fix},1}$ / $t_{\text{fix},2}$ / $t_{\text{fix},3}$ for the corresponding $h_{\text{nom},1}$ / $h_{\text{nom},2}$ / $h_{\text{nom},3}$

Material code for identification of different materials

Type	HSA, HSA-BW, HSA-F (carbon steel)	HSA-R2 (Stainless steel grade A2)	HSA-R (stainless steel grade A4)
Material code			
	Letter code without mark	Letter code with two marks	Letter code with three marks

Letter code for anchor length and maximum thickness of the fixture t_{fix}

Type	HSA, HSA-BW, HSA-R2, HSA-R, HSA-F					
Size	M6	M8	M10	M12	M16	M20
h_{nom} [mm]	37 / 47 / 67	39 / 49 / 79	50 / 60 / 90	64 / 79 / 114	77 / 92 / 132	90 / 115 / 130
Letter	t_{fix}	$t_{fix,1}/t_{fix,2}/t_{fix,3}$	$t_{fix,1}/t_{fix,2}/t_{fix,3}$	$t_{fix,1}/t_{fix,2}/t_{fix,3}$	$t_{fix,1}/t_{fix,2}/t_{fix,3}$	$t_{fix,1}/t_{fix,2}/t_{fix,3}$
z	5/-/-	5/-/-	5/-/-	5/-/-	5/-/-	5/-/-
y	10/-/-	10/-/-	10/-/-	10/-/-	10/-/-	10/-/-
x	15/5/-	15/5/-	15/5/-	15/-/-	15/-/-	15/-/-
w	20/10/-	20/10/-	20/10/-	20/5/-	20/5/-	20/-/-
v	25/15/-	25/15/-	25/15	25/10/-	25/10/-	25/-/-
u	30/20/-	30/20/-	30/20/-	30/15/-	30/15/-	30/5/-
t	35/25/5	35/25/-	35/25/-	35/20/-	35/20/-	35/10/-
s	40/30/10	40/30/-	40/30/-	40/25/-	40/25/-	40/15/-
r	45/35/15	45/35/5	45/35/5	45/30/-	45/30/-	45/20/5
q	50/40/20	50/40/10	50/40/10	50/35/-	50/35/-	50/25/10
p	55/45/25	55/45/15	55/45/15	55/40/5	55/40/-	55/30/15
o	60/50/30	60/50/20	60/50/20	60/45/10	60/45/5	60/35/20
n	65/55/35	65/55/25	65/55/25	65/50/15	65/50/10	65/40/25
m	70/60/40	70/60/30	70/60/30	70/55/20	70/55/15	70/45/30
l	75/65/45	75/65/35	75/65/35	75/60/25	75/60/20	75/50/35
k	80/70/50	80/70/40	80/70/40	80/65/30	80/65/25	80/55/40
j	85/75/55	85/75/45	85/75/45	85/70/35	85/70/30	85/60/45
i	90/80/60	90/80/50	90/80/50	90/75/40	90/75/35	90/65/50
h	95/85/65	95/85/55	95/85/55	95/80/45	95/80/40	95/70/55
g	100/90/70	100/90/60	100/90/60	100/85/50	100/85/45	100/75/60
f	105/95/75	105/95/65	105/95/65	105/90/55	105/90/50	105/80/65
e	110/100/80	110/100/70	110/100/70	110/95/60	110/95/55	110/85/70
d	115/105/85	115/105/75	115/105/75	115/100/65	115/100/60	115/90/75
c	120/110/90	120/110/80	120/110/80	125/110/75	120/105/65	120/95/80
b	125/115/95	125/115/85	125/115/85	135/120/85	125/110/70	125/100/85
a	130/120/100	130/120/90	130/120/90	145/130/95	135/120/80	130/105/90
aa	-	-	-	155/140/105	145/130/90	-
ab	-	-	-	165/150/115	155/140/100	-
ac	-	-	-	175/160/125	165/150/110	-
ad	-	-	-	180/165/130	190/175/135	-
ae	-	-	-	230/215/180	240/225/185	-
af	-	-	-	280/265/230	290/275/235	-
ag	-	-	-	330/315/280	340/325/285	-

Anchor length in bolt type and grey shaded are standard items. For selection of other anchor length, check availability of the items.

Setting information

Setting details

Anchor size			M6			M8			M10		
Nominal anchorage depth	h_{nom}	[mm]	37	47	67	39	49	79	50	60	90
Minimum base material thickness	h_{min}	[mm]	100	100	120	100	100	120	100	120	160
Minimum spacing	s_{min}	[mm]	35	35	35	35	35	35	50	50	50
Minimum edge distance	c_{min}	[mm]	35	35	35	40	35	35	50	40	40
Nominal diameter of drill bit	d_0	[mm]	6			8			10		
Cutting diameter of drill bit	$d_{cut} \leq$	[mm]	6,4			8,45			10,45		
Depth of drill hole	$h_1 \geq$	[mm]	42	52	72	44	54	84	55	65	95
Diameter of clearance hole in the fixture	$d_r \leq$	[mm]	7			9			12		
Torque moment	T_{inst}	[Nm]	5			15			25		
Width across	SW	[mm]	10			13			17		
Anchor size			M12			M16			M20		
Nominal anchorage depth	h_{nom}	[mm]	64	79	114	77	92	132	90	115	130
Minimum base material thickness	h_{min}	[mm]	100	140	180	140	160	180	160	220	220
Minimum spacing	s_{min}	[mm]	70	70	70	90	90	90	195	175	175
Minimum edge distance	c_{min}	[mm]	70	65	55	80	75	70	130	120	120
Nominal diameter of drill bit	d_0	[mm]	12			16			20		
Cutting diameter of drill bit	$d_{cut} \leq$	[mm]	12,5			16,5			20,55		
Depth of drill hole	$h_1 \geq$	[mm]	72	87	122	85	100	140	98	123	138
Diameter of clearance hole in the fixture	$d_r \leq$	[mm]	14			18			22		
Torque moment	T_{inst}	[Nm]	50			80			200		
Width across	SW	[mm]	19			24			30		

For spacing (edge distance) smaller than critical spacing (critical edge distance) the design loads have to be reduced.

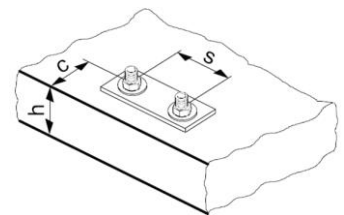

Installation equipment

Anchor size		M6	M8	M10	M12	M16	M20	
Rotary hammer		TE2 – TE16					TE40 – TE80	
Other tools		hammer, torque wrench, blow out pump						
Machine tightening								
Setting tool		-	S-TB HSA				-	
Impact screw driver		-	Hilti S/W 14-A Hilti S/W 22-A			Hilti S/W 22T-A		-
Speed	HAS, HAS-BW, HAS-F	-	1		3	-1)		-
	HAS-R2, HAS-R	-	3					-
Setting time t_{set} [sec]		-	4				-	

1) The impact screw driver operates with a fixed speed.

Setting parameters

Anchor size			M6			M8			M10		
Nominal anchorage depth	h_{nom}	[mm]	37	47	67	39	49	79	50	60	90
Effective anchorage depth	h_{ef}	[mm]	30	40	60	30	40	70	40	50	80
Critical spacing for splitting failure	$s_{cr,sp}$	[mm]	100	120	130	130	180	200	190	210	290
Critical edge distance for splitting failure	$c_{cr,sp}$	[mm]	50	60	65	65	90	100	95	105	145
Critical spacing for concrete cone failure	$s_{cr,N}$	[mm]	90	120	180	90	120	210	120	150	240
Critical edge distance for concrete cone failure	$c_{cr,N}$	[mm]	45	60	90	45	60	105	60	75	120
Anchor size			M12			M16			M20		
Nominal anchorage depth	h_{nom}	[mm]	64	79	114	77	92	132	90	115	130
Effective anchorage depth	h_{ef}	[mm]	50	65	100	65	80	120	75	100	115
Critical spacing for splitting failure	$s_{cr,sp}$	[mm]	200	250	310	230	280	380	260	370	400
Critical edge distance for splitting failure	$c_{cr,sp}$	[mm]	100	125	155	115	140	190	130	185	200
Critical spacing for concrete cone failure	$s_{cr,N}$	[mm]	150	195	300	195	240	360	225	300	345
Critical edge distance for concrete cone failure	$c_{cr,N}$	[mm]	75	97,5	150	97,5	120	180	112,5	150	172,5

Setting instructions

*For detailed information on installation see instruction for use given with the package of the product

1. Hole drilling		
<p>Hammer drilling (HD): M6-M20</p>	<p>Hammer drilling with Hilti hollow drill bit (HDB): M12-M20</p>	<p>Diamond drilling (DD): M10-M20</p>
2. Cleaning		
<p>Manual cleaning (MC): M6-M20</p>	<p>Automatic cleaning (AC): M12-M20</p>	
3. Anchor setting		
<p>Hammer setting: M6-M20</p>	<p>Machine setting (impact screw driver with setting tool): M8-M16</p>	
4. Check setting		
5. Anchor torquing		
<p>Torque wrench: M6-M20</p> <p>$T_{inst} = 20 \text{ Nm}$ 13 mm</p>	<p>Impact screw driver with setting tool: M8-M16</p> <p>S-TB</p>	

HSV Expansion anchor

Economical expansion anchor for uncracked concrete

Anchor version



HSV (F)
(M8-M16)



HSV-BW
(M8-M16)

Benefits

- Torque-controlled mechanical expansion allows immediate load application
- Setting mark
- Cold-formed to prevent breaking during installation
- Raised impact section prevents thread damage during installation
- Drill bit size is same as anchor size for easy installation.

Base material



Concrete
(non-cracked)

Basic loading data (for a single anchor)

All data in this section applies to:

- Correct setting (See setting instruction)
- No edge distance and spacing influence
- Concrete as specified in the table
- Steel failure
- Minimum base material thickness
- Concrete C 20/25, $f_{ck,cube} = 25 \text{ N/mm}^2$

Effective anchorage depth for static ^{a)}

Anchor size	M8		M10		M12		M16	
Eff. anchorage depth range h_{ef} [mm]	30	40	40	50	50	65	65	80

a) HSV-F only for sizes M10, M12 and M16

Mean ultimate resistance

Anchor size	M8		M10		M12		M16		
Tension $N_{Ru,m}$ [kN]	HSV / HSV-BW	11,0	15,9	15,9	18,6	19,2	26,6	35,1	48,0
	HSV-F	-	-	13,2	18,6	19,2	26,6	35,1	48,0
Shear $V_{Ru,m}$ [kN]	HSV / HSV-BW	8,9	8,9	15,1	15,1	23,7	23,7	44,5	44,5
	HSV-F	-	-	15,1	15,1	23,7	23,7	44,5	44,5

Characteristic resistance

Anchor size			M8		M10		M12		M16	
Tension N_{Rk}	HSV / HSV-BW	[kN]	8,3	12,0	12,0	14,0	14,5	20,0	26,5	36,1
	HSV-F		-	-	10,0	14,0	14,5	20,0	26,5	36,1
Shear V_{Rk}	HSV / HSV-BW	[kN]	8,3	8,5	12,8	14,4	17,9	22,6	42,4	42,4
	HSV-F		-	-	12,8	14,4	17,9	22,6	42,4	42,4

Design resistance

Anchor size			M8		M10		M12		M16	
Tension N_{Rd}	HSV / HSV-BW	[kN]	4,6	6,7	8,0	9,3	9,7	13,3	14,7	20,1
	HSV-F		-	-	6,7	9,3	9,7	13,3	14,7	20,1
Shear V_{Rd}	HSV / HSV-BW	[kN]	5,5	6,8	8,5	11,5	11,9	18,1	33,9	33,9
	HSV-F		-	-	8,5	11,5	11,9	18,1	33,9	33,9

Recommended loads ^{a)}

Anchor size			M8		M10		M12		M16	
Tension N_{Rec}	HSV / HSV-BW	[kN]	3,3	4,8	5,7	6,7	6,9	9,5	10,5	14,3
	HSV-F		-	-	4,8	6,7	6,9	9,5	10,5	14,3
Shear V_{Rec}	HSV / HSV-BW	[kN]	4,0	4,9	6,1	8,2	8,5	12,9	24,2	24,2
	HSV-F		-	-	6,1	8,2	8,5	12,9	24,2	24,2

a) With overall partial safety factor for action $\gamma = 1,4$. The partial safety factors for action depend on the type of loading and shall be taken from national regulations.

Materials

Mechanical properties ^{a)}

Anchor size			M8	M10	M12	M16
Nominal tensile strength	f_{uk}	[N/mm ²]	580	660	660	660
Yield strength	f_{yk}	[N/mm ²]	464	528	528	528
Stressed cross-section, thread	A_s	[mm ²]	36,6	58,0	84,3	157
Stressed cross-section, neck	$A_{s, neck}$	[mm ²]	26,9	39,6	63,6	105,7
Moment of resistance	W	[mm ³]	31,2	62,3	109,2	277,5
Char. bending resistance for rod or bolt with 5.8 steel grade	$M^0_{Rk,s}$	[Nm]	19,5	41,1	72,1	166,5

a) HSV-F only for sizes M10, M12 and M16.

Material quality

Part		Material
Bolt	HSV	Carbon steel, galvanized to min. 5 μ m
	HSV - BW	Carbon steel, galvanized to min. 5 μ m with DIN 9021 washer and DIN 127b spring washer
	HSV-F	For M10 to M16 hot dipped galvanized to min. 42 μ m with DIN 9021 washer and DIN 127b spring washer

Anchor dimension ^{a)}

Anchor size		M8	M10	M12	M16
Shaft diameter at the cone	d_R [mm]	5,85	7,1	9,0	11,6
Maximum length of the anchor	l_1 [mm]	75	100	150	140
Length of expansion sleeve	l_2 [mm]	15	17,6	20,6	24

a) HSV-F only for sizes M10, M12 and M16.

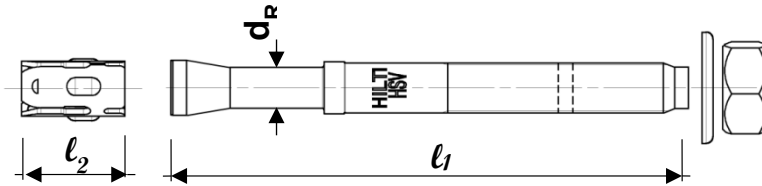

Setting information

Setting details ^{a)}

Anchor size		M8		M10		M12		M16	
Effective anchorage depth	h_{ef} [mm]	30	40	40	50	50	65	65	80
Nominal embedment depth	h_{nom} [mm]	39	49	51	61	62	77	81	96
Nominal diameter of drill bit	d_0 [mm]	8		10		12		16	
Cutting diameter of drill bit	$d_{cut} \leq$ [mm]	8,45		10,45		12,5		16,5	
Depth of drill hole	$h_1 \geq$ [mm]	45	55	60	70	70	85	90	105
Min. thickness of fixture ^{b)}	$t_{fix,min}$ [mm]	5	0	5	0	5	0	5	0
Max. thickness of fixture ^{b)}	HSV(-BW) $t_{fix,max}$ [mm]	20	10	35	25	70	55	35	20
	HSV-F	-	-	55	45	60	45	35	20
Diameter of clearance hole in the fixture	$d_f \leq$ [mm]	9		12		14		18	
Torque moment	T_{inst} [Nm]	15		30		50		100	
Width across nut flats	SW [mm]	13		17		19		24	

a) HSV-F only for sizes M10, M12 and M16.

b) The values are only valid for HSV with standard washer. For HSV-BW with DIN 9021 washer and DIN 127b spring washer the thickness of the fixture has to be reduced.

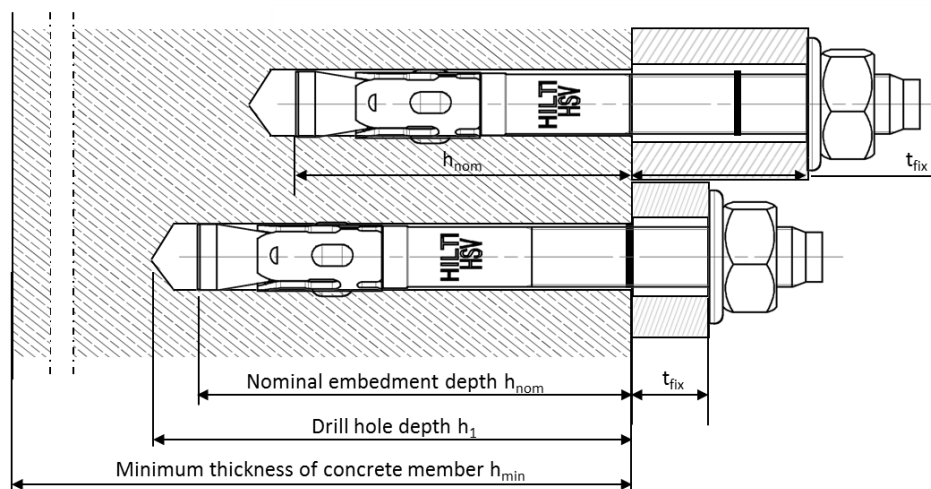

Installation equipment ^{a)}

Anchor size	M8	M10	M12	M16
Rotary hammer	TE 1 – TE 30			
Other tools	Blow out pump, hammer, torque wrench			

a) HSV-F only for sizes M10, M12 and M16.

Setting parameters ^{a)}

Anchor size				M8		M10		M12		M16	
Effective anchorage depth	HSV (-BW)	h_{ef}	[mm]	30	40	40	50	50	65	65	80
	HSV-F			-	-	40	50	50	65	65	80
Minimum base material thickness	HSV (-BW)	$h_{min} \geq$	[mm]	100	100	100	120	140	140	130	170
	HSV-F			-	-	120	120	140	140	170	170
Minimum spacing	HSV (-BW)	$s_{min} \geq$	[mm]	60	60	70	70	80	80	120	100
	HSV-F			-	-	105	105	120	120	190	190
Minimum edge distance	HSV (-BW)	$c_{min} \geq$	[mm]	60	60	70	70	90	90	120	100
	HSV-F			-	-	105	105	140	140	140	140
Critical spacing for splitting failure ^{b)}	HSV (-BW)	$s_{cr,sp}$	[mm]	180	240	240	300	300	390	390	480
	HSV-F			-	-	240	300	300	390	390	480
Critical edge distance for splitting failure ^{b)}	HSV (-BW)	$c_{cr,sp}$	[mm]	90	120	120	150	150	195	195	240
	HSV-F			-	-	120	150	150	195	195	240
Critical spacing for concrete cone failure ^{b)}	HSV (-BW)	$s_{cr,N}$	[mm]	90	120	120	150	150	195	195	240
	HSV-F			-	-	120	150	150	195	195	240
Critical edge distance for concrete cone failure ^{b)}	HSV (-BW)	$c_{cr,N}$	[mm]	45	60	60	75	75	97,5	97,5	120
	HSV-F			-	-	60	75	75	97,5	97,5	120

a) HSV-F only for sizes M10, M12 and M16.

b) In a case of smaller edge distance and spacing than $c_{cr,sp}$, $s_{cr,sp}$, and $s_{cr,N}$ the load values shall be reduced according ETAG 001, Annex C.

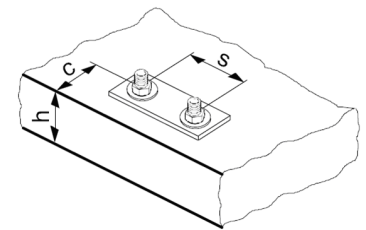

Setting instruction

*For detailed information on installation see instruction for use given with the package of the product.

Setting instruction for HSV (-BW)

1. Drilling

2. Cleaning

3. Inserting the anchor

4. Checking

5. Checking

6. Applying setting tool

HSB Expansion anchor

Everyday economical expansion anchor for uncracked concrete

Anchor version



HSB
(M8-M16)

Benefits

- Torque-controlled mechanical expansion allows immediate load application
- Drill bit size is same as anchor size for easy installation
- Suitable for pre- and through-fastening
- ETA approved

Base material

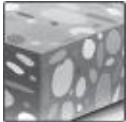

Concrete
(non-cracked)

Load conditions

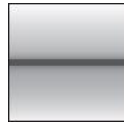

Static/
quasi-static

Installation conditions



Hammer
drilled holes

Other information



European
Technical
Assessment



CE
conformity

Approvals / certificates

Description	Authority / Laboratory	No. / date of issue
European technical assessment ^{a)}	DIBt, Berlin	ETA-17/0452 / 2017-07-27

^{a)} All data given in this section according to ETA-17/0452, issue 2017-07-27.

Basic loading data (for a single anchor)

All data in this section applies to:

- Correct setting (See setting instruction)
- No edge distance and spacing influence
- Concrete as specified in the table
- *Steel* failure
- Minimum base material thickness
- Concrete C 20/25, $f_{ck,cube} = 25 \text{ N/mm}^2$

Effective anchorage depth

Anchor size		M8	M10	M12	M16
Eff. anchorage depth range	h_{ef} [mm]	30	40	50	65

Mean ultimate resistance

Anchor size		M8	M10	M12	M16
Tension $N_{Ru,m}$	[kN]	11,0	15,9	19,4	35,1
Shear $V_{Ru,m}$	[kN]	8,9	15,1	23,7	44,5

Characteristic resistance

Anchor size		M8	M10	M12	M16
Tension N_{Rk}	[kN]	8,3	12,0	14,6	26,5
Shear V_{Rk}	[kN]	8,3	12,8	17,9	42,4

Design resistance

Anchor size		M8	M10	M12	M16
Tension N_{Rd}	[kN]	4,6	8,0	9,7	14,7
Shear V_{Rd}	[kN]	5,5	8,5	11,9	33,9

Recommended loads ^{a)}

Anchor size		M8	M10	M12	M16
Tension N_{Rec}	[kN]	3,3	5,7	7,0	10,5
Shear V_{Rec}	[kN]	4,0	6,1	8,5	24,2

a) With overall partial safety factor for action $\gamma = 1,4$. The partial safety factors for action depend on the type of loading and shall be taken from national regulations.

Materials

Mechanical properties

Anchor size		M8	M10	M12	M16
Nominal tensile strength	f_{uk} [N/mm ²]	580	660	660	660
Yield strength	f_{yk} [N/mm ²]	464	528	528	528
Stressed cross-section, thread	A_s [mm ²]	36,6	58,0	84,3	157
Stressed cross-section, neck	$A_{s, neck}$ [mm ²]	26,9	39,6	63,6	105,7
Moment of resistance	W [mm ³]	31,2	62,3	109,2	277,5
Char. bending resistance for rod or bolt with 5.8 steel grade	$M^0_{Rk,s}$ [Nm]	19,5	41,1	72,1	166,5

Material quality

Part	Material
Expansion sleeve	Carbon steel, galvanized
Bolt	Carbon steel, galvanized, rupture elongation ($l_0=5d$)>8%
Washer	Carbon steel, galvanized
Hexagon nut	Carbon steel, galvanized

Anchor dimension

Anchor size		M8	M10	M12	M16
Min. inner diameter of washer	d_1 [mm]	8,4	10,5	13	17
Min. outer diameter of washer	d_w [mm]	16	20	24	30
Min. thickness of washer	h [mm]	1,6	2	2,5	3



Letter code for identification of fixture thickness

Anchor size		M8	M10	M12	M16
Letter	t_{fix}	[mm]	[mm]	[mm]	[mm]
z		5	5	5	5
w		20	20	20	20
t		35	35	35	-
s		-	-	-	40
q		-	50	-	-
p		55	-	-	-
n		-	-	65	-
m		-	70	-	-
j		-	-	-	85
h		-	-	95	-

Setting information

Setting details

Anchor size		M8	M10	M12	M16
Effective anchorage depth	h_{ef} [mm]	30	40	50	65
Nominal anchorage depth	h_{nom} [mm]	39	50	64	77
Nominal diameter of drill bit	d_0 [mm]	8	10	12	16
Cutting diameter of drill bit	$d_{cut} \leq$ [mm]	8,45	10,45	12,5	16,5
Depth of drill hole	$h_1 \geq$ [mm]	44	55	72	85
Diameter of clearance hole in the fixture	$d_f \leq$ [mm]	9	12	14	18
Torque moment	T_{inst} [Nm]	15	30	50	80
Width across flats	SW [mm]	13	17	19	24

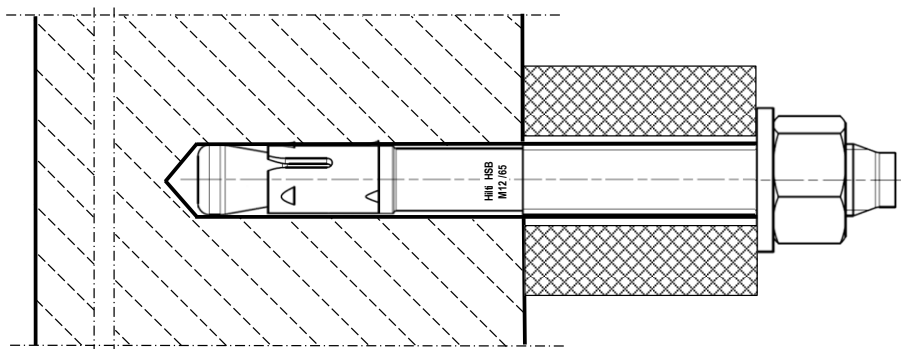

Installation equipment

Anchor size	M8	M10	M12	M16
Rotary hammer	TE 2 – TE 16			
Other tools	Blow out pump, hammer, torque wrench			

Setting parameters

Anchor size		M8	M10	M12	M16
Min. thickness of concrete member	h_{min} [mm]	100	100	100	140
Min. spacing	$s_{min} \geq$ [mm]	60	70	80	100
Min. edge distance	$c_{min} \geq$ [mm]	60	70	90	100

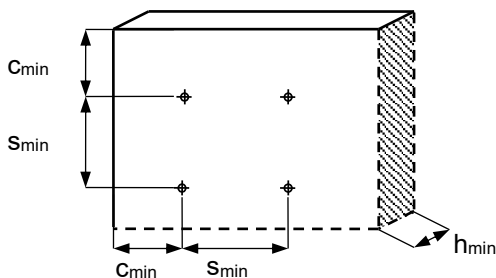

Setting instruction

*For detailed information on installation see instruction for use given with the package of the product.

Setting instruction for HSB

- 1. Hammer drilling**
- 2. Manual cleaning**
- 3. Insert the anchor**
- 4. Check setting**
- 5. Torque wrench**
- 6. Check installation**

HUS3 Screw anchor

Ultimate performance screw anchor

Chemical anchors

Screw

Mechanical anchors

Plastic/Light duty metal anchors

Insulation anchors

Anchor version



HUS3-H
(6-14)

HUS3-HF
(8-14)

HUS3-C
(6-14)

HUS3-A
(6)

HUS3-P
(6)

HUS3-PL
(6)

HUS3-PS
(6)

HUS3-I
(6)

HUS3-I Flex
(6)

Benefits

- High productivity - less drilling and fewer operations than with conventional anchors
- ETA approval for cracked and non-cracked concrete
- ETA approval for Seismic C1 and C2
- ETA approval for adjustability (unscrew-rescrew)
- High loads
- Small edge and spacing distance
- abZ (DIBt) approval for reusability in fresh concrete ($f_{ck, cube} = 10/15/20 \text{ Nmm}^2$) for temporary applications
- Three embedment depths for maximum design flexibility
- HUS3-HF with multilayer coatings for additional corrosion protection
- Forged-on washer and hexagon head with no protruding thread
- Through fastening

Base material



Concrete (non-cracked)

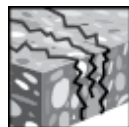

Concrete (cracked)

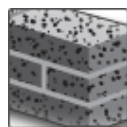

Solid brick



Autoclaved aerated concrete

Load conditions



Static / quasi-static



Seismic
ETA-C1,C2



Fire resistance

Installation conditions

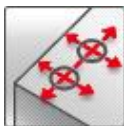

Small edge distance and spacing

Other information



European Technical Assessment



CE conformity



PROFIS Anchor design software



DIBt Approval Reusability

Approvals / certificates

Description	Authority / Laboratory	No. / date of issue
European Technical Assessment	DIBt, Berlin	ETA-13/1038 / 2018-04-27
Fire test report	DIBt, Berlin	ETA-13/1038 / 2018-04-27

a) All data given in this section according ETA-13/1038 issue 2018-04-27.

Static and quasi-static loading data (for a single anchor)

All data in this section applies to:

- Correct setting (See setting instruction)
- No edge distance and spacing influence
- Steel failure
- Minimum base material thickness
- Concrete C 20/25, $f_{ck,cube} = 25 \text{ N/mm}^2$

Anchorage depth

Anchor size	6		8			10			14			
Type	HUS3-	H,C,A, I,I-flex	P,PS	H,C,HF			H,C,HF			H,HF		H
Nominal embedment depth h_{nom} [mm]	h_{nom1}	h_{nom2}	h_{nom1}	h_{nom2}	h_{nom3}	h_{nom1}	h_{nom2}	h_{nom3}	h_{nom1}	h_{nom2}	h_{nom3}	
	55	55	50	60	70	55	75	85	65	85	115	

Characteristic resistance

Anchor size	6		8			10			14			
Type	HUS3-	H,C,A, I,I-flex	P,PS, PL	H,C,HF			H,C,HF			H,HF		H
Non-cracked concrete												
Tension N_{Rk} [kN]	9,0	7,5	9,0	12,0	16,0	12,0	20,0	27,8	17,5	27,3	44,4	
Shear V_{Rk} [kN]	12,5	12,5	12,8	19,0	22,0	13,5	30,0	34,0	35,0	54,5	62,0	
Cracked concrete												
Tension N_{Rk} [kN]	6,0	6,0	6,0	9,0	12,0	9,7	16,2	19,8	12,5	19,4	31,7	
Shear V_{Rk} [kN]	12,5	12,5	9,1	19,0	22,0	9,7	30,0	34,0	24,9	38,9	62,0	

Design resistance

Anchor size	6		8			10			14			
Type	HUS3-	H,C,A, I,I-flex	P,PS, PL	H,C,HF			H,C,HF			H,HF		H
Non-cracked concrete												
Tension N_{Rd} [kN]	5,0	4,2	6,0	8,0	10,7	8,0	13,3	18,5	11,7	18,2	29,6	
Shear V_{Rd} [kN]	8,3	8,3	8,5	12,7	14,7	9,0	20,0	22,7	23,3	36,3	41,3	
Cracked concrete												
Tension N_{Rd} [kN]	3,3	3,3	4,0	6,0	8,0	6,4	10,8	13,2	8,3	13,0	21,1	
Shear V_{Rd} [kN]	8,3	8,3	6,1	12,7	14,7	6,4	20,0	22,7	16,6	25,9	41,3	

Recommended loads^{a)}

Anchor size	6		8			10			14			
Type	HUS3-	H,C,A, I,I-flex	P,PS, PL	H,C,HF			H,C,HF			H,HF		H
Non-cracked concrete												
Tension N_{Rec} [kN]	3,6	3,0	4,3	5,7	7,6	5,7	9,5	13,2	8,3	13,0	21,2	
Shear V_{Rec} [kN]	6,0	6,0	6,1	9,0	10,5	6,5	14,3	16,2	16,6	26,0	29,5	
Cracked concrete												
Tension N_{Rec} [kN]	2,4	2,4	2,9	4,3	5,7	4,6	7,7	9,4	5,9	9,3	15,1	
Shear V_{Rec} [kN]	6,0	6,0	4,3	9,0	10,5	4,6	14,3	16,2	11,9	18,5	29,5	

a) With overall partial safety factor for action $\gamma = 1,4$. The partial safety factors for action depend on the type of loading and shall be taken from national regulations.

Seismic loading data (for single anchor)

All data in this section applies to:

- Correct setting (See setting instruction)
- No edge distance and spacing influence
- Steel failure
- Minimum base material thickness
- Concrete C 20/25, $f_{ck,cube} = 25 \text{ N/mm}^2$
- $\alpha_{gap} = 1,0$ (using Hilti seismic filling set)

Anchorage depth for seismic C2

Anchor size		8	10	14
Type	HUS3 -	H	H	H
Nominal anchor. depth range	h_{nom} [mm]	h_{nom3}	h_{nom3}	h_{nom3}
		-	85	115
Effective anchorage depth	h_{eff} [mm]	-	67,1	91,8

Characteristic resistance in case of seismic performance category C2

Anchor size		8	10	14
with Hilti filling set ($\alpha_{gap} = 1,0$)				
Type	HUS3 -	H, HF	H, HF	H, HF
Tension $N_{Rd,seis}$	[kN]	-	9,4	17,7
Shear $V_{Rd,seis}$		-	25,6	46,6
without Hilti filling set ($\alpha_{gap} = 0,5$)				
Type	HUS3	H, HF	H, HF, C	H, HF
Tension $N_{Rd,seis}$	[kN]	-	9,4	17,7
Shear $V_{Rd,seis}$		-	8,9	17,2

Design resistance in case of seismic performance category C2

Anchor size		8	10	14
with Hilti filling set ($\alpha_{gap} = 1,0$)				
Type	HUS3 -	H, HF	H, HF	H, HF
Tension $N_{Rk,seis}$	[kN]	-	6,3	11,8
Shear $V_{Rk,seis}$		-	17,1	31,1
without Hilti filling set ($\alpha_{gap} = 0,5$)				
Type	HUS3	H, HF	H, HF, C	H, HF
Tension $N_{Rk,seis}$	[kN]	-	6,3	11,8
Shear $V_{Rk,seis}$		-	5,9	11,5

Anchorage depth for seismic C1

Anchor size		8		10		14	
Type	HUS3-	H		H		H	
Nominal anchorage depth range	h_{nom} [mm]	h_{nom2}	h_{nom3}	h_{nom2}	h_{nom3}	h_{nom2}	h_{nom3}
		60	70	75	85	85	115
Effective anchorage depth	h_{ef} [mm]	46,4	54,9	58,6	67,1	66,3	91,8

Characteristic resistance in case of seismic performance category C1

Anchor size		8		10		14	
with Hilti filling set ($\alpha_{\text{gap}} = 1,0$)							
Type	HUS3 -	H, HF		H, HF		H, HF	H
Tension $N_{Rk,seis}$	[kN]	9,0	12,0	13,8	16,8	16,5	26,9
Shear $V_{Rk,seis}$	[kN]	11,9	11,9	16,8	17,7	22,5	34,5
without Hilti filling set ($\alpha_{\text{gap}} = 0,5$)							
Type	HUS3 -	H, HF		H, HF, C		H, HF	H
Tension $N_{Rk,seis}$	[kN]	9,0	12,0	13,7	16,8	16,5	26,9
Shear $V_{Rk,seis}$	[kN]	6,0	6,0	8,4	8,9	11,3	17,3

Design resistance in case of seismic performance category C1

Anchor size		8		10		14	
with Hilti filling set ($\alpha_{\text{gap}} = 1,0$)							
Type	HUS3 -	H, HF		H, HF		H, HF	H
Tension $N_{Rd,seis}$	[kN]	6,0	8,0	9,2	11,2	11,0	17,9
Shear $V_{Rd,seis}$	[kN]	7,9	7,9	11,2	11,8	15,0	23,0
without Hilti filling set ($\alpha_{\text{gap}} = 0,5$)							
Type	HUS3 -	H, HF		H, HF, C		H, HF	H
Tension $N_{Rd,seis}$	[kN]	6,0	8,0	9,1	11,2	11,0	17,9
Shear $V_{Rd,seis}$	[kN]	4,0	4,0	5,6	5,9	7,5	11,5

Fire resistance

All data in this section applies to:

- Correct setting (see setting instruction)
- No edge distance and spacing influence
- Minimum base material thickness
- For more fire resistance data please see the full ETA-13/1038 report.

Recommended loads under fire exposure¹⁾

Anchor size		6					
Type	HUS3-	H	C	A	I / I-Flex	P	PS / PL
Nominal embedment depth	h_{nom} [mm]	55					
Steel failure for tension and shear load ($F_{\text{Rec,s,fi}} = N_{\text{Rec,s,fi}} = V_{\text{Rec,s,fi}}$)							
Recommended tensile and shear load	R30	$F_{\text{Rec,s,fi}}$ [kN]	1,6				
	R120	$F_{\text{Rec,s,fi}}$ [kN]	0,7				
	R30	$M^0_{\text{Rec,s,fi}}$ [Nm]	1,4				
	R120	$M^0_{\text{Rec,s,fi}}$ [Nm]	0,6				
Pull-out failure							
Recommended resistance	R30 to R90	$N_{\text{Rec,p,fi}}$ [kN]	1,5				
	R120	$N_{\text{Rec,p,fi}}$ [kN]	1,2				
Concrete cone failure							
Edge distance ²⁾	R30 to R120	$c_{\text{cr,fi}}$ [mm]	2 h_{ef}				
Spacing	R30 to R120	$s_{\text{cr,fi}}$ [mm]	2 $c_{\text{cr,fi}}$				
Concrete pry-out failure							
	R30 to R120	k [-]	1,5				
The anchorage depth has to be increased for wet concrete by at least 30 mm compared to the given value.							

- 1) The recommended loads under fire exposure include a safety factor for resistance under fire exposure $\gamma_{\text{Ms,fire}} = 1,0$ and the partial safety factor for action $\gamma_{\text{Ms,fire}} = 1,0$. The partial safety factors for action shall be taken from national regulations, in this case it was taken the factor $\gamma = 1,4$.
- 2) In case of fire attack from more than one side, the minimum edge distance shall be ≥ 300 mm.

Recommended loads under fire exposure¹⁾

Anchor size			8			10			14		
Type	HUS3-		H, HF			H, HF			H, HF		
Nominal embedment depth	h_{nom}	[mm]	h_{nom1}	h_{nom2}	h_{nom3}	h_{nom1}	h_{nom2}	h_{nom3}	h_{nom1}	h_{nom2}	h_{nom3}
			50	60	70	55	75	85	65	85	115
Steel failure for tension and shear load ($F_{Rec,s,fi} = N_{Rec,s,fi} = V_{Rec,s,fi}$)											
Recommended tensile and shear load	R30	$F_{Rec,s,fi}$ [kN]	3,2	3,5	3,8	6,1	6,2	10,4	10,6		
	R120	$F_{Rec,s,fi}$ [kN]	1,2	1,2	1,5	2,4	2,5	4,0	4,3		
	R30	$M^0_{Rec,s,fi}$ [Nm]	3,8	4,1	4,4	9,1	9,2	20,4	20,6		
	R120	$M^0_{Rec,s,fi}$ [Nm]	1,5	1,4	1,7	3,5	3,7	7,9	8,3		
Pull-out failure											
Recommended resistance	R30 to R90	$N_{Rec,p,fi}$ [kN]	1,5	2,3	3,0	2,4	4,0	4,9	3,1	4,8	7,8
	R120	$N_{Rec,p,fi}$ [kN]	1,2	1,8	2,4	1,9	3,2	3,9	2,5	3,8	6,3
Concrete cone failure											
Characteristic resistance	R30 to R90	$N^0_{Rec,p,fi}$ [kN]	1,8	2,6	4,0	2,0	4,7	6,6	3,0	6,4	14,4
	R120	$N^0_{Rec,p,fi}$ [kN]	1,4	2,1	3,2	1,6	3,8	5,3	2,4	5,1	11,5
Edge distance ²⁾	R30 to R120	$c_{cr,fi}$ [mm]	2 h_{ef}								
Spacing	R30 to R120	$s_{cr,fi}$ [mm]	2 $c_{cr,fi}$								
Concrete pry-out failure											
	R30 to R120	k [-]	1,0	2,0	1,0	2,0					

The anchorage depth has to be increased for wet concrete by at least 30 mm compared to the given value.

1) The recommended loads under fire exposure include a safety factor for resistance under fire exposure $\gamma_{Ms,fire} = 1,0$ and the partial safety factor for action $\gamma_{Ms,fire} = 1,0$. The partial safety factors for action shall be taken from national regulations, in this case it was taken the factor $\gamma = 1,4$.

Recommended loads under fire exposure¹⁾

Anchor size			8			10		
Type	HUS3-		C			C		
Nominal embedment depth	h_{nom}	[mm]	h_{nom1}	h_{nom2}	h_{nom3}	h_{nom1}	h_{nom2}	h_{nom3}
			50	60	70	55	75	85
Steel failure for tension and shear load ($F_{Rec,s,fi} = N_{Rec,s,fi} = V_{Rec,s,fi}$)								
Recommended tensile and shear load	R30	$F_{Rec,s,fi}$ [kN]	0,5			1,2		
	R120	$F_{Rec,s,fi}$ [kN]	0,2			0,6		
	R30	$M^0_{Rec,s,fi}$ [Nm]	0,6			1,7		
	R120	$M^0_{Rec,s,fi}$ [Nm]	0,3			0,9		
Pull-out failure								
Recommended resistance	R30 to R90	$N_{Rec,p,fi}$ [kN]	1,5	2,3	3,0	2,4	4,0	5,0
	R120	$N_{Rec,p,fi}$ [kN]	1,2	1,8	2,4	1,9	3,2	4,0
Concrete cone failure								
Characteristic resistance	R30 to R90	$N^0_{Rec,p,fi}$ [kN]	1,8	2,6	4,0	2,0	4,7	6,6
	R120	$N^0_{Rec,p,fi}$ [kN]	1,5	2,1	3,2	1,6	3,8	5,3
Edge distance ²⁾	R30 to R120	$c_{cr,fi}$ [m]	2 h_{ef}					
Spacing	R30 to R120	$s_{cr,fi}$ [m]	2 $c_{cr,fi}$					
Concrete pry-out failure								
	R30 to R120	k [-]	1,0	2,0	1,0	2,0		

The anchorage depth has to be increased for wet concrete by at least 30 mm compared to the given value.

2) In case of fire attack from more than one side, the minimum edge distance shall be ≥ 300 mm.

1) The recommended loads under fire exposure include a safety factor for resistance under fire exposure $\gamma_{Ms,fire} = 1,0$ and the partial safety factor for action $\gamma_{Ms,fire} = 1,0$. The partial safety factors for action shall be taken from national regulations, in this case it was taken the factor $\gamma = 1,4$.

2) In case of fire attack from more than one side, the minimum edge distance shall be ≥ 300 mm.

Materials

Mechanical properties

Anchor size		6	8	10	14
Type	HUS3-	H,C,A,I, I-flex,P,PS,PL	H,C,HF	H,C,HF	H,HF
Nominal tensile strength f_{uk}	[N/mm ²]	930	810	805	730
Yield strength f_{yk}	[N/mm ²]	745	695	690	630
Stressed cross-section A_s	[mm ²]	26,9	48,4	77,0	131,7
Moment of resistance W	[mm ³]	19,6	47	95	213
Characteristic bending resistance	[Nm]	21	46	92	187

Material quality

Type	Material
HUS3 - H,A,C,P,PS, PL,I,I-Flex	Carbon steel, galvanized
HUS3 - HF	Carbon steel, multi-layer coating ^{a)}

a) Multi-layer coating provides a higher corrosion resistance compared to regular hot dip galvanized (HDG) systems with a 40µm coating thickness.

Head configuration

Type	Part		
HUS3-H HUS3-HF	Hexagonal head		
HUS3-C	Countersunk head		
HUS3-A	External thread		
HUS3-P	Pan head		
HUS3-PS	Pan head (small)		
HUS3-PL	Pan head (large)		
HUS3-I	Internal thread		
HUS3-I Flex	External thread		

Anchor dimensions

Anchor size			6	8	10	14
Type	HUS3-		H,C,A,I, I-flex,P,PS,PL	H,C,HF	H,C,HF	H,HF
Threaded outer diameter	d_t	[mm]	7,85	10,30	12,40	16,85
Core diameter	d_k	[mm]	5,85	7,85	9,90	12,95
Shaft diameter	d_s	[mm]	6,15	8,45	10,55	13,80
Stressed section	A_s	[mm ²]	26,9	48,4	77,0	131,7

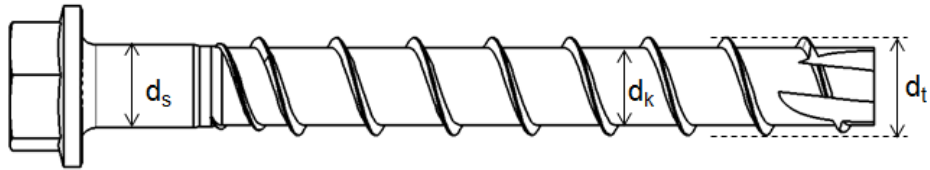

HUS3: Hilti Universal Screw 3rd generation

H: Hexagonal head

10: Screw diameter

45/25/15: Maximum thickness fixture t_{fix1} / t_{fix2} / t_{fix3} related to the embedment depth h_{nom1} / h_{nom2} / h_{nom3} (see Annex B3).

Screw length and thickness of fixture for HUS3

Anchor size		6					
Nominal embedment depth [mm]		h_{nom1}					
		55					
Type		H	C	A	I / I-Flex	P	PS / PL
Thickness of fixture		t_{fix1}	t_{fix2}	t_{fix1}	t_{fix2}	t_{fix1}	t_{fix2}
Length of screw [mm]	55	-	-	0	0	-	-
	60	5	5	-	-	5	5
	70	-	15	-	-	-	-
	80	25	-	-	-	25	-
	100	45	-	-	-	-	-
	120	65	-	-	-	-	-
	135	-	-	80	-	-	-
	155	-	-	100	-	-	-
	175	-	-	120	-	-	-
195	-	-	140	-	-	-	

Screw length and thickness of fixture for HUS3-C

Anchor size		8			10		
Nominal embedment depth [mm]		h_{nom1}	h_{nom2}	h_{nom3}	h_{nom1}	h_{nom2}	h_{nom3}
		50	60	70	55	75	85
Thickness of fixture		t_{fix1}	t_{fix2}	t_{fix3}	t_{fix1}	t_{fix2}	t_{fix3}
Length of screw [mm]	65	15	5	-	-	-	-
	70	-	-	-	15	-	-
	75	25	15	-	-	-	-
	85	35	25	15	-	-	-
	90	-	-	-	35	15	-
	100	-	-	-	45	25	15

Screw length and thickness of fixture for HUS3-H and HUS3-HF¹⁾

Anchor size		8			10			14		
		h_{nom1}	h_{nom2}	h_{nom3}	h_{nom1}	h_{nom2}	h_{nom3}	h_{nom1}	h_{nom2}	h_{nom3}
Nominal embedment depth [mm]		50	60	70	55	75	85	65	85	115
Thickness of fixture		t_{fix1}	t_{fix2}	t_{fix3}	t_{fix1}	t_{fix2}	t_{fix3}	t_{fix1}	t_{fix2}	t_{fix3}
Length of screw [mm]	55	5	-	-	-	-	-	-	-	-
	60	-	-	-	5	-	-	-	-	-
	65	15	5	-	-	-	-	-	-	-
	70	-	-	-	15	-	-	-	-	-
	75	25	15	5	-	-	-	10	-	-
	80	-	-	-	25	5	-	-	-	-
	85	35	25	15	-	-	-	-	-	-
	90	-	-	-	35	15	5	-	-	-
	100	50	40	30	45	25	15	35	15	-
	110	-	-	-	55	35	25	-	-	-
	120	70	60	50	-	-	-	-	-	-
	130	-	-	-	75	55	45	65	45	15
150	100	90	80	95	75	65	85	65	35	

1) HUS3-HF available for size 14 with h_{nom1} and h_{nom2} only

Setting information
Setting details

Anchor size			6					
Type	HUS3-		H	C	A	P, PS	I-Flex	PL
Nominal embedment depth [mm]			h_{nom1}					
			55					
Nominal diameter of drill bit	d_0	[mm]	6					
Cutting diameter of drill bit	$d_{cut} \leq$	[mm]	6,4					
Clearance hole diameter	$d_f \leq$	[mm]	9					10
Wrench size	SW	[mm]	13	-	13	-	13	-
Countersunk head diameter	d_h	[mm]	-	11,5	-			
Torx size	TX	-	-	30	-	30	-	30
Depth of drill hole in floor/wall position	$h_1 \geq$	[mm]	65					
Depth of drill hole (with adjustability setting process)	$h_1 \geq$	[mm]	58					
Installation Torque	T_{inst}	[mm]	25					

Setting details

Anchor size			8			10			14		
Type	HUS3-		H, HF, C			H, HF, C			H, HF		H
Nominal embedment depth	[mm]	h_{nom1}	h_{nom2}	h_{nom3}	h_{nom1}	h_{nom2}	h_{nom3}	h_{nom1}	h_{nom2}	h_{nom3}	
		50	60	70	55	75	85	65	85	115	
Nominal diameter of drill bit	d_0	[mm]	8			10			14		
Cutting diameter of drill bit	$d_{cut} \leq$	[mm]	8,45			10,45			14,50		
Clearance hole diameter	$d_f \leq$	[mm]	12			14			18		
Wrench size	SW	[mm]	13			15			21		
Countersunk head diameter	d_h	[mm]	18			21			-		
Torx size	TX	-	45			50			-		
Depth of drill hole in floor/wall position	$h_1 \geq$	[mm]	60	70	80	65	85	95	75	95	125
Depth of drill hole (with adjustability setting process)	$h_1 \geq$	[mm]	-	80	90	-	95	105	-		

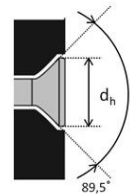
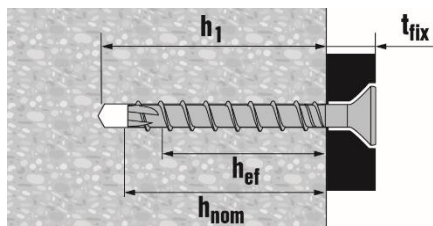
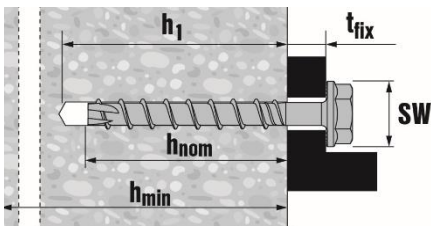

Installation equipment

Anchor size	6	8	10	14
Type	HUS3- H,C,A,I, I-flex,P,PS,PL	H,C,HF	H,C,HF	H,HF
Rotary hammer	TE 2 - TE 7	TE 2 – TE 30		
Drill bit for concrete, solid clay brick and solid sand-lime brick	CX 6	CX 8	CX 10	CX 14
Drill bit for aerated concrete	CX 5	CX 6	CX 8	-
Socket wrench insert	S-NSD 13 ½ L	SI-S ½" 13S	SI-S ½" 15S	SI-S ½" 21S
Torx	TX30	S-SY TX45	S-SY TX50	-
Tube for temporary application ¹⁾	-	HRG 8	HRG 10	HRG 14
Setting tool for cracked and un-cracked concrete	SIW 14 A SIW 22 A	SIW 14 A, SIW 22A, SIW 22 T-A	SIW 22 A SIW 22 T-A	SIW 22 T-A
Setting tool for solid brick and aerated concrete	-	SFH 22 A		
Setting tool for hollow core slab	SIW 14 A SIW 22 A	SIW 22 A		

1) Only for HUS3-H

Setting parameters

Anchor size		6	8			10			14		
Type	HUS3-										
Nominal embedment depth	h_{nom} [mm]	55	50	60	70	55	75	85	65	85	115
Minimum base material thickness	h_{min} [mm]	100	100	100	120	100	130	140	120	160	200
Minimum spacing	s_{min} [mm]	35	50	50	50	50	50	50	60	60	60
			40 $c \geq 50$								
Minimum edge distance	c_{min} [mm]	35	40	40	40	50	50	50	60	60	60
Critical spacing for splitting failure	$s_{cr,sp}$ [mm]	126	120	140	170	130	180	220	170	200	280
Critical edge distance for splitting failure	$c_{cr,sp}$ [mm]	63	60	70	85	65	90	110	85	100	140
Critical spacing for concrete cone failure	$s_{cr,N}$ [mm]	$3 h_{ef}$									
Critical edge distance for concrete cone failure	$c_{cr,N}$ [mm]	$1,5 h_{ef}$									

For spacing (edge distance) smaller than critical spacing (critical edge distance) the design loads have to be reduced (see system design resistance).

Critical spacing and critical edge distance for splitting failure apply only for non-cracked concrete. For cracked concrete only the critical spacing and critical edge distance for concrete cone failure are decisive.

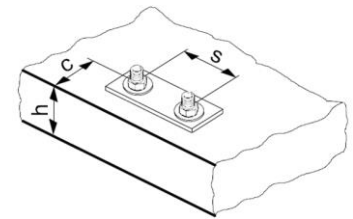

Setting instructions

*For detailed information on installation see instruction for use given with the package of the product

Setting instruction without adjustment

1. Drilling

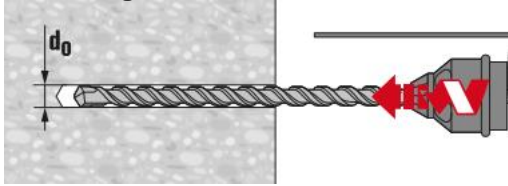

2. Cleaning

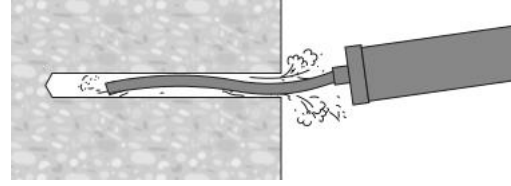

3. Installing the anchor by impact screw driver

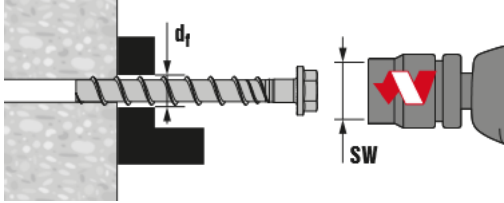

4. Checking

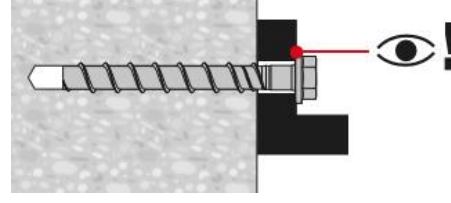

Setting instruction with adjustment

1. Drilling

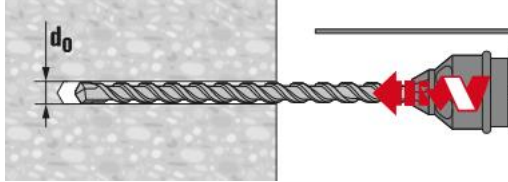

2. Cleaning

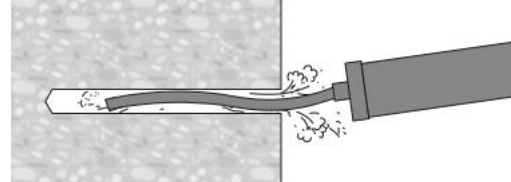

3. Inserting the anchor

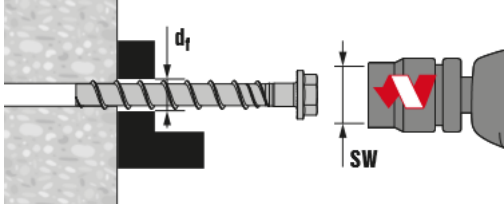

4. Anchor installed

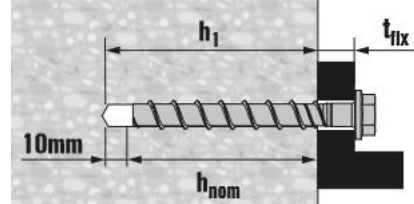

5. Checking

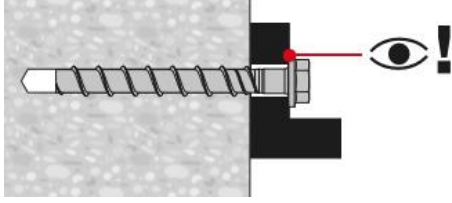

6. Adjusting the anchor by impact screw driver

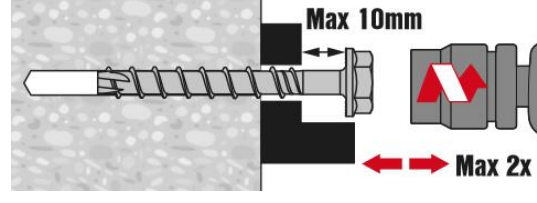

7. Checking

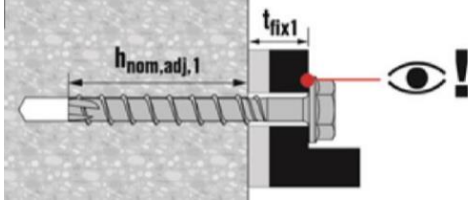

8. Adjusting the anchor by impact screw driver

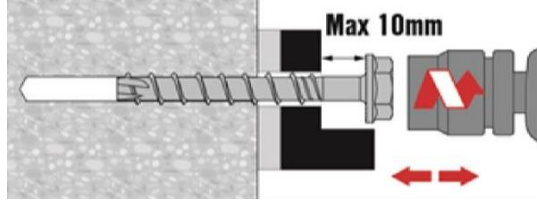

9. Checking

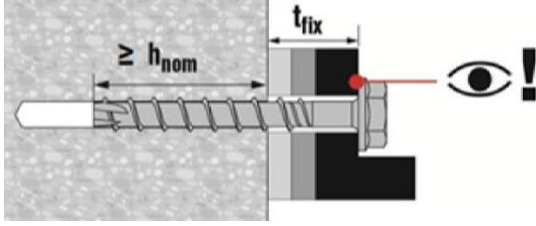

The anchor can be adjusted max. two times.

The total allowed thickness of shims added during the adjustment process is 10 mm.

The final embedment depth after adjustment process must be larger or equal than h_{nom2} or h_{nom3} .

For size 14 only, hole cleaning is not required under specific conditions. Check instructions for use for more information.

Basic loading data for temporary application in standard and fresh concrete <28 days old, $f_{ck,cube} \geq 10 \text{ N/mm}^2$

All data in this section applies to the following conditions:

- Strength class, $f_{ck,cube} \geq 10 \text{ N/mm}^2$
- Only temporary use
- Screw is reusable, before each usage it must be checked according to Hilti instruction for use with the suited tube Hilti HRG
- Design resistance and recommended loads are valid for single anchor only
- Design resistance as well as recommended loads are valid for all load directions and valid for both cracked and non-cracked concrete
- Minimum base material thickness
- No edge distance and spacing influence
- Valid for HUS3-H only
- All data in this section for sizes 10 and 14 according to DIBt approval Z-21.8.2018 issue 2014-04-01
- All data in this section for size 8 according to Hilti Technical Data

Design resistance

		Hilti Tech. Data			DIBt approval Z-21.8-2018					
Anchor size HUS3-H		8			10			14		
Nominal embedment depth	h_{nom} [mm]	50	60	70	55	75	85	65	85	115
Cracked and non-cracked concrete										
Tensile N_{rd} =	$f_{ck,cube} \geq 10 \text{ N/mm}^2$ [kN]	2,5	3,2	4,7	3,3	5,3	6,3	4,4	7,0	12,3
	$f_{ck,cube} \geq 15 \text{ N/mm}^2$ [kN]	3,1	4,0	5,7	4,0	6,4	7,8	5,4	8,5	15,0
Shear V_{rd}	$f_{ck,cube} \geq 20 \text{ N/mm}^2$ [kN]	3,6	4,6	6,6	4,7	7,4	9,0	6,2	9,9	17,3

Recommended load ^{a)}

		Hilti Tech. Data			DIBt approval Z-21.8-2018					
Anchor size HUS3-H		8			10			14		
Nominal embedment depth	h_{nom} [mm]	50	60	70	55	75	85	65	85	115
Tensile N_{rec} =	$f_{ck,cube} \geq 10 \text{ N/mm}^2$ [kN]	1,8	2,3	3,4	2,4	3,8	4,5	3,1	5,0	8,8
	$f_{ck,cube} \geq 15 \text{ N/mm}^2$ [kN]	2,2	2,9	4,1	2,9	4,6	5,5	3,8	6,1	10,7
Shear V_{rec}	$f_{ck,cube} \geq 20 \text{ N/mm}^2$ [kN]	2,6	3,3	4,7	3,3	5,3	6,4	4,4	7,1	12,4

a) With overall partial safety factor for action $\gamma = 1,4$. The partial safety factors for action depend on the type of loading and shall be taken from national regulations.

Setting information

Setting details

		Hilti			DIBt approval Z-21.8-2018					
Anchor size	HUS3-H	8			10			14		
Nominal anchorage depth	h_{nom} [mm]	50	60	70	55	75	85	65	85	115
Minimum base material thickness	h_{min} [mm]	100	115	145	115	150	175	130	175	255
Minimum spacing	s_{min} [mm]	180	225	285	225	300	345	255	345	510
Minimum edge distance direction 1	c_1 [mm]	60	75	95	75	100	115	85	115	170
Minimum edge distance direction 2	c_2 [mm]	95	115	145	115	150	175	130	180	260

Setting parameters

		Hilti			DIBt approval Z-21.8-2018					
Anchor size	HUS3-H	8			10			14		
Nominal anchorage depth	h_{nom} [mm]	50	60	70	55	75	85	65	85	115
Nominal diameter of drill bit	d_o [mm]	8			10			14		
Cutting diameter of drill bit	$d_{cut} \leq$ [mm]	8,45			10,45			14,50		
Depth of drill bit	$h_1 \leq$ [mm]	60	70	80	65	85	95	75	95	125
Diameter of clearance hole in the fixture	$d_r \leq$ [mm]	12			14			18		
Width across	SW [mm]	13			15			21		
Impact screw driver		Hilti SIW 22 T-A								
Suited tube		Hilti HRG 8			Hilti HRG 10			Hilti HRG 14		

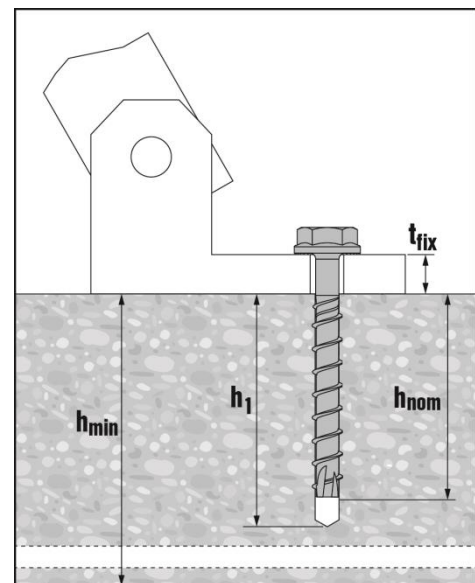
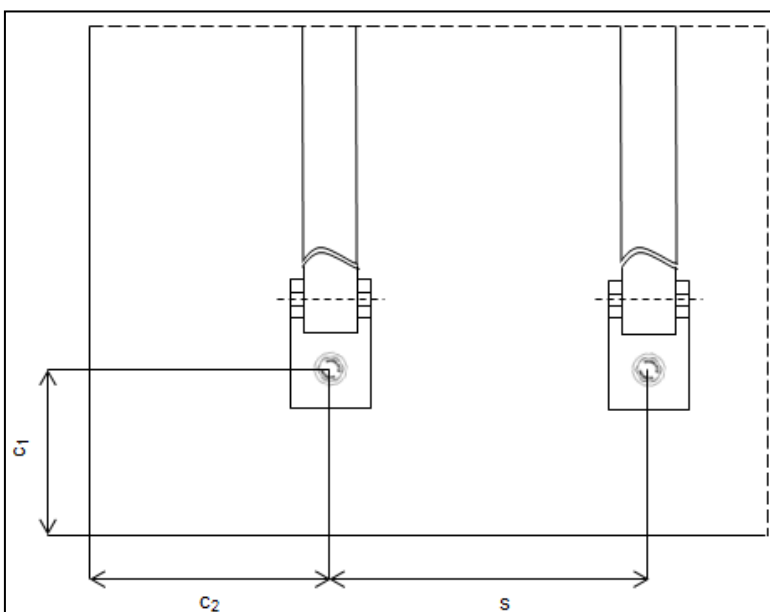

Tube specification

Anchor size / tube		8 / HRG 8	10 / HRG 10	14 / HRG 14
Inner tube diameter	\varnothing_i [mm]	9,7	11,7	16,0
Outer tube diameter	\varnothing_e [mm]	15,0	17,0	22,0
Tube length	Lt [mm]	23,0	28,0	40,3

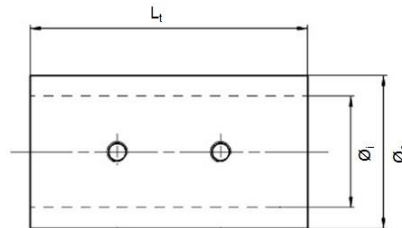

Setting instructions

*For detailed information on installation see instruction for use given with the package of the product

Instruction for use – re-use of screw	
<p>1. Removing the anchor with Screw-driver</p>	<p>2. Removing the anchor</p>
<p>3. Checking with tube Hilti HRG</p>	<p>4. Checking with tube Hilti HRG</p>
<p>5. Drilling</p>	<p>6. Reinstall based on setting instructions</p>

Basic loading data (for a single anchor) in solid masonry units



All data in this section applies to:

- Load values valid for holes drilled with TE rotary hammers in hammering mod
- Correct anchor setting (see instruction for use, setting details)
- The core/material ratio may not exceed 15 % of a bed joint area
- The brim area around holes must be at least 70mm
- Edge distances, spacing and other influences, see below
- All data given in this section according to Hilti Technical Data

Nominal embedment depth

Anchor size		6	8	10
Nominal embedment depth	h_{nom} [mm]	55	60	75

Recommended loads for HUS3

Anchor size			6	8	10
			A, H, I, C, P, PS, PL	H, C, HF	H, C, HF
		Compressive strength class [N/mm ²]	F _{rec} Tensile and shear loads		
	Solid clay brick Mz	≥ 8	0,6	-	-
	12/2,0	≥ 10	0,7	-	-
	DIN 105 / EN 771-1	≥ 12	0,8	1,1	1,4
		≥ 16	0,9	-	-
		≥ 20	0,9	1,6	2,0
	Solid sand-lime brick Mz	≥ 8	0,8	-	-
	12/2,0	≥ 10	0,9	-	-
	DIN 106/EN 771-2	≥ 12	1,0	1,3	1,4
		≥ 16	1,1	-	-
		≥ 20	1,2	1,7	2,1
	Aerated concrete PPW 6-0,4 DIN 4165/EN 771-4	≥ 6	0,4	0,7	0,9

Permissible anchor location in brick and block walls

Edge distance and spacing influence

- The technical data for HUS3 anchors are reference loads for MZ 12, KS 12 and PPW 6. Due to the large variation of natural stone slid bricks, on site anchor testing is recommended to validate technical data
- The HUS3 anchor was installed and tested in center of solid bricks as shown. The HUS3 anchor was not tested in the mortar joint between solid bricks or in hollow bricks, however a load reduction is expected
- For brick walls where anchor position in brick can not be determined, 100 % anchor testing is recommended
- Distance to free edge free edge to solid masonry (Mz and KS) units ≥ 200mm
- Distance to free edge free edge to solid masonry (autoclaved aerated gas concrete) units ≥ 170mm
- The minimum distance to horizontal and vertical mortar joint (c_{min}) is started in drawing below
- Minimum anchor spacing (s_{min}) in one brick/block is ≥ 80 mm

Limits

- All data is for multiple use for non-structural applications
- Plaster, graveling, lining or levelling courses are regarded as non-bearing and may not be taken into account for the calculation of embedment depth
- The decisive resistance to tension loads is the lower value of N_{rec} (brick breakout, pull out) and $N_{max,pb}$ (pull out of one brick)

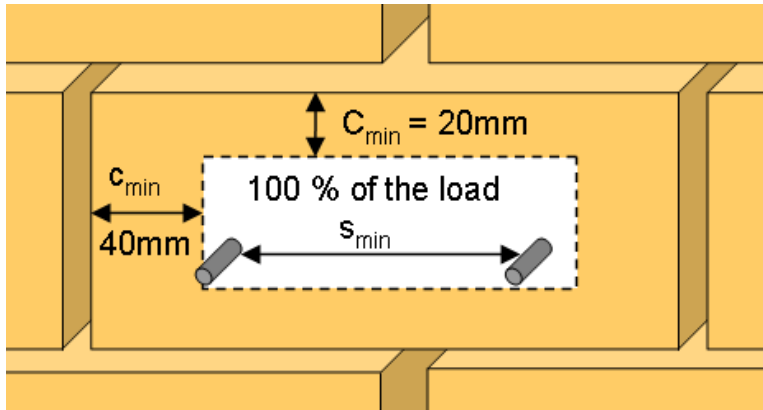

Basic loading data for single anchor in Hollow core slab

All data in this section applies to

- Correct setting (See setting instruction)
- No edge distance and spacing influence
- Ratio core width / web thickness $w/e \leq 4,2$
- Concrete C 30/37 to C 50/60

Characteristic resistance

Anchor size			8	10
Type	HUS3		C, H, HF	C, H, HF
Bottom flange thickness	$d_b \geq$	[mm]	30	30
All load directions	F_{Rk}	[kN]	2,0	2,0

Design resistance

Anchor size			8	10
Type	HUS3		C, H, HF	C, H, HF
Bottom flange thickness	$d_b \geq$	[mm]	30	30
All load directions	F_{Rd}	[kN]	1,3	1,3

Recommended loads

Anchor size			8	10
Type	HUS3		C, H, HF	C, H, HF
Bottom flange thickness	$d_b \geq$	[mm]	30	30
All load directions ^{a)}	F_{rec}	[kN]	0,95	0,95

- a) With overall partial safety factor for action $\gamma = 1,4$. The partial safety factors for action depend on the type of loading and shall be taken from national regulations.

Anchor Type	Size [mm]	Length [mm]	$d_b=30$ [mm]		$d_b=35$ [mm]		$d_b=40$ [mm]		$d_b=50$ [mm]	
			$t_{fix,min}$ [mm]	$t_{fix,max}$ [mm]	$t_{fix,min}$ [mm]	$t_{fix,max}$ [mm]	$t_{fix,min}$ [mm]	$t_{fix,max}$ [mm]	$t_{fix,min}$ [mm]	$t_{fix,max}$ [mm]
HUS3-H	8	55	5	15	5	10	5	5	5	5
		65	5	25	5	20	5	15	5	5
		75	5	35	5	30	5	25	5	15
		85	15	45	15	40	15	35	15	25
		100	30	60	30	55	30	50	30	40
		120	50	80	50	75	50	70	50	60
		150	80	110	80	105	80	100	80	90
HUS3-HF	8	65	5	25	5	20	5	15	5	5
		75	5	35	5	30	5	25	5	15
		85	15	45	15	40	15	35	15	25
		100	30	60	30	55	30	50	30	40
HUS3-C	8	65	15	25	15	20	15	15	15	5
		75	15	35	15	30	15	25	15	15
		85	15	45	15	40	15	35	15	25
HUS3-H	10	60	5	15	5	10	5	5	5	5
		70	15	25	15	20	15	15	15	5
		80	5	35	5	30	5	25	5	15
		90	5	45	5	40	5	35	5	25
		100	15	55	15	50	15	45	15	35
		110	25	65	25	60	25	55	25	45
		130	45	85	45	80	45	75	45	65
		150	65	105	65	100	65	95	65	85
HUS3-HF	10	60	5	15	5	10	5	5	5	5
		80	5	35	5	30	5	25	5	15
		100	15	55	15	50	15	45	15	35
		110	25	65	25	60	25	55	25	45
HUS3-C	10	70	15	25	15	20	15	15	15	10
		90	15	45	15	40	15	35	15	25
		100	15	55	15	50	15	45	15	35

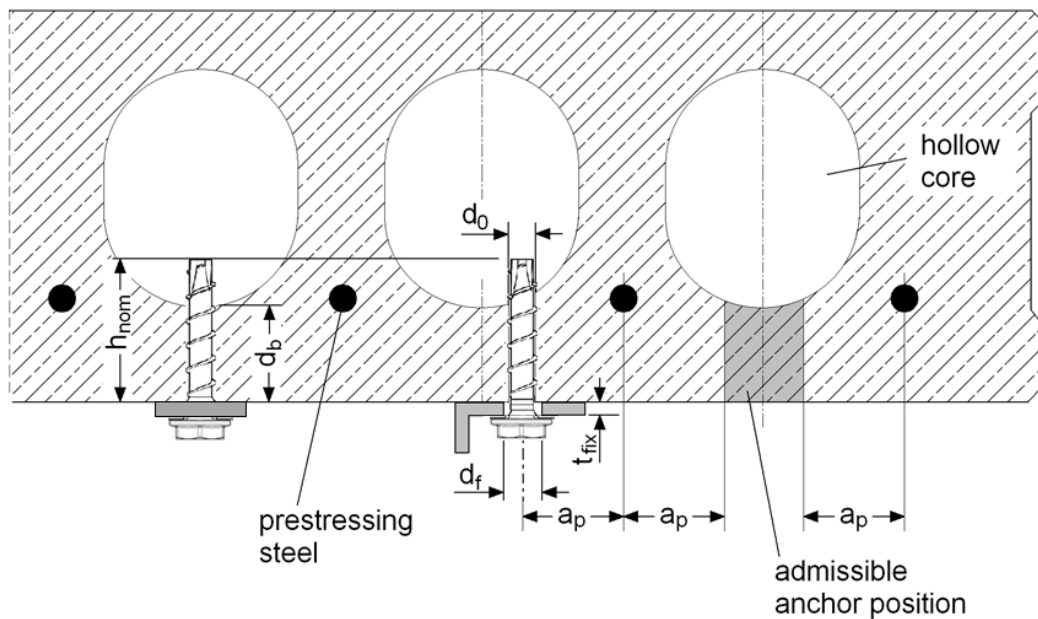

Anchor spacing and edge distance

Anchor size		8	10
Type	HUS3	C, H, HF	C, H, HF
Minimum edge distance	$c_{min} \geq$ [mm]	100	
Minimum anchor spacing	$s_{min} \geq$ [mm]	100	
Minimum distance between anchor groups	$a_{min} \geq$ [mm]	100	

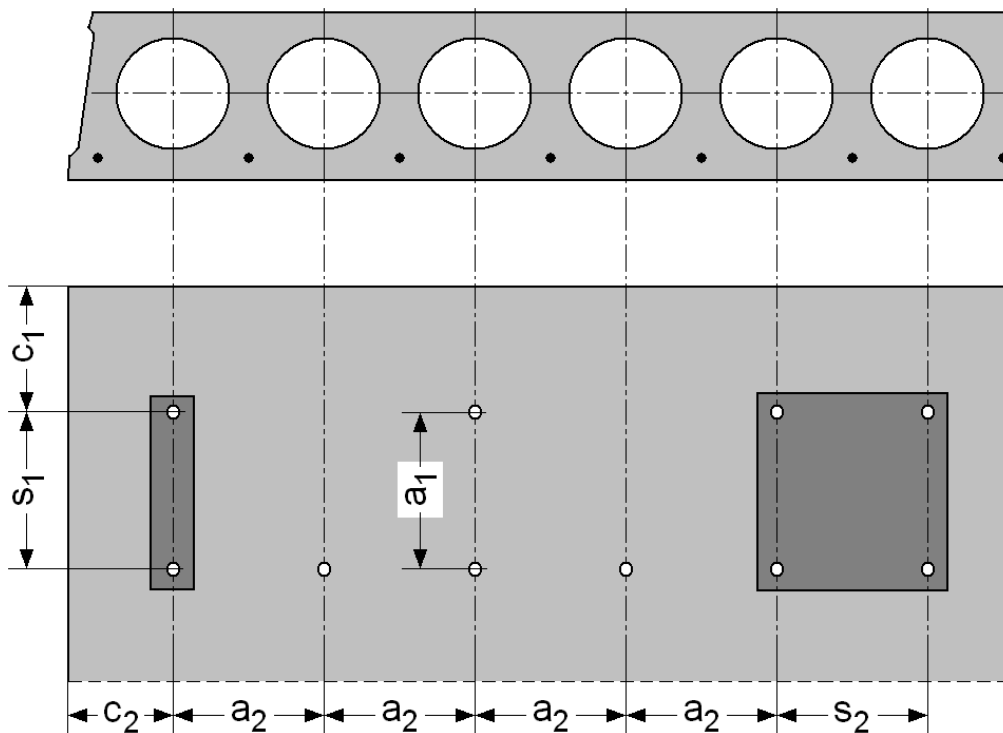

Setting instructions

*For detailed information on installation see instruction for use given with the package of the product

Installation in hollow core slabs

1. Checking the anchor with tube Hilti HSB

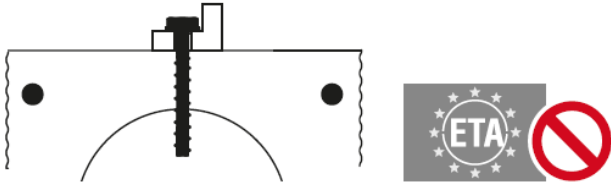

2. Positioning pre-stressed steel



3. Marking pre-stressed steel position

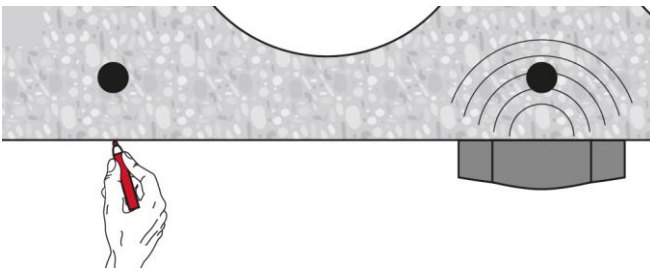

4. Marking pre-stressed steel position

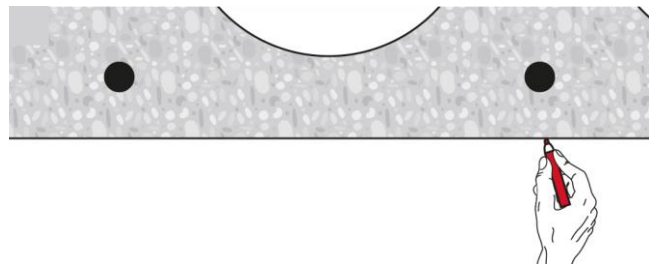

5. Drilling

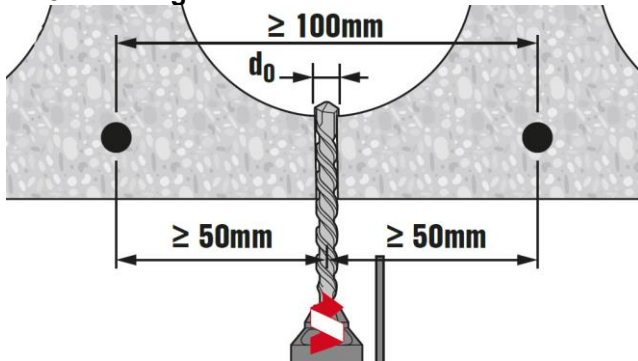

6. Setting the anchor

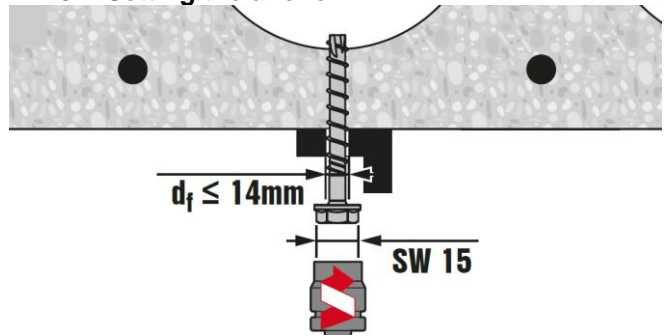

7. Setting the anchor

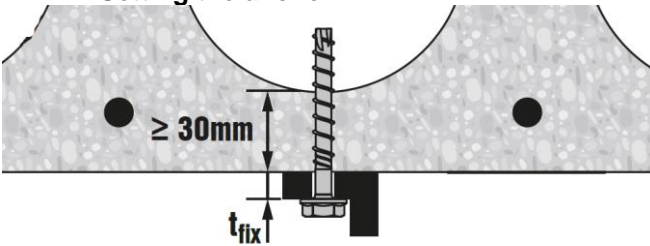

8. Checking

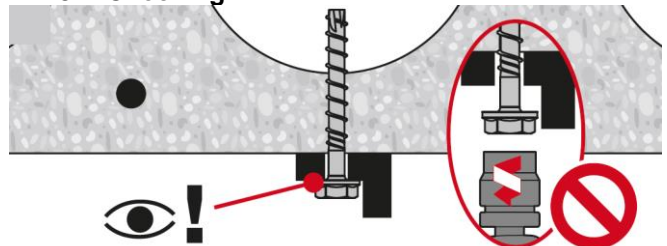

Chemical anchors

Screw











Mechanical anchors





Plastic/Light duty metal anchors

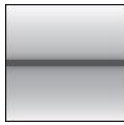

Insulation anchors

HUS/HUS3 Screw anchor

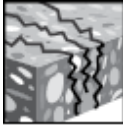
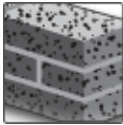
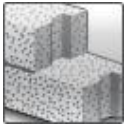
Ultimate performance screw anchor for redundant fastening applications

Anchor version	Benefits
 HUS3-H/HF (6-10)	<ul style="list-style-type: none"> - Quick and easy setting - Low expansion forces in base materials - Removable - Forged-on washer and hexagon head with no protruding thread - ETA approval for cracked and non cracked concrete and for hollow core slabs - High productivity – less drilling and fewer operations than with conventional anchors - Through-fastening and pre-setting (based on the head configuration)
 HUS-HR (6)	
 HUS3-C (6-10)	
 HUS-CR (6)	
 HUS3-A (6)	
 HUS3-PL (6)	
 HUS3-P (6)	
 HUS3-PS (6)	
 HUS3-I (6)	
 HUS3-I Flex (6)	

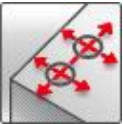
Base material	Load conditions
 Concrete (non-cracked)	 Static / quasi-static  Fire resistance
 Concrete (cracked)	
 Solid brick	
 Autoclaved aerated concrete	
 Prestressed hollow core slabs	

Installation conditions	Other information
 Small edge distance and spacing	 European Technical Assessment  CE conformity  Corrosion resistance

Chemical anchors

Screw

Mechanical anchors

Plastic/Light duty metal anchors

Insulation anchors

Approvals / certificates

Description	Authority / Laboratory	No. / date of issue
European Technical Assessment	DIBt, Berlin	ETA-10/0005 / 2018-11-12
Fire test report	DIBt, Berlin	ETA-10/0005 / 2018-11-12

a) All data given in this section according ETA-10/0005 issue 2018-11-12

Basic loading data (for a single anchor)

All data in this section applies to:

- Correct setting (See setting instruction)
- No edge distance and spacing influence
- Concrete C 20/25, $f_{ck,cube} = 25 \text{ N/mm}^2$

Anchorage depth

Type		HUS ¹⁾	HUS ²⁾	HUS ³⁾
		HR, CR	HR,CR	H,P,PS,I,I-Flex,A,C
Nominal embedmt.depth	h_{nom} [mm]	30	35	35

1) Hilti Technical Data for embedment depth of 30 mm

2) ETA-10/0005 issue 2018-11-12

Characteristic resistance for all loads directions

Type		HUS ¹⁾	HUS ²⁾		HUS ³⁾
		HR,CR	HR,CR		H,PL,P,PS,I,I-Flex,A,C
Fastener size		6 all lengths	6x40 6x45	6x60 6x70	6 all lengths
$35 \text{ mm} \leq c < 80 \text{ mm}$	F_{Rk}^0 [kN]	2	3		2
$c > 80 \text{ mm}$	F_{Rk}^0 [kN]	2	3,5	5	3

1) Hilti Technical Data for embedment depth of 30 mm

2) ETA-10/0005 issue 2018-11-12

Design resistance for all loads directions

Type		HUS ¹⁾	HUS ²⁾		HUS ³⁾
		HR,CR	HR	CR	H,PL,P,PS,I,I-Flex,A,C
Fastener size		6 all lengths	6x40 6x45	6x60 6x70	6 all lengths
$35 \text{ mm} \leq c < 80 \text{ mm}$	F_{Rd}^0 [kN]	1	1,4		1,3
$c > 80 \text{ mm}$	F_{Rd}^0 [kN]	1	1,7	2,4	2,0

1) Hilti Technical Data for embedment depth of 30 mm

2) ETA-10/0005 issue 2018-11-12

Recommended loads for all load directions

Type		HUS ¹⁾	HUS ²⁾		HUS ³⁾
		HR,CR	HR	CR	H,PL,P,PS,I,I-Flex,A,C
Fastener size		6 all lengths	6x40 6x45	6x60 6x70	6 all lengths
$35 \text{ mm} \leq c < 80 \text{ mm}$	F_{Rec}^0 [kN]	0,7	1,0		0,9
$c > 80 \text{ mm}$	F_{Rec}^0 [kN]	0,7	1,2	1,7	1,4

1) Hilti Technical Data for embedment depth of 30 mm

2) ETA-10/0005 issue 2018-11-12

3) With overall partial safety factor for action $\gamma = 1,4$. The partial safety factors for action depend on the type of loading and shall be taken from national regulations

Requirements for redundant fastening

The definition of redundant fastening according to Member States is given in the EAD 330747 § 1.2.1. In Absence of a definition by a Member State the following default values may be taken.

Minimum number of fixing points	Minimum number of anchors per fixing point	Maximum design load of action N_{Sd} per fixing point ^{a)}
3	1	2 kN
4	1	3 kN

a) The value for maximum design load of actions per fastening point N_{Sd} is valid in general that means all fastening points are considered in the design of the redundant structural system. The value N_{Sd} may be increased if the failure of one (=most unfavourable) fixing point is taken into account in the design (serviceability and ultimate limit state) of the structural system e.g. suspended ceiling.

Materials

Mechanical properties

Type		HUS	HUS3
		HR,CR	H,PL,P,PS,I,I-Flex,A,C
Nominal tensile strength f_{uk}	[N/mm ²]	1040	930
Stressed cross-section A_s	[mm ²]	22,9	26,9
Moment of resistance W	[mm ³]	15,5	19,7
Design bending resistance $M^0_{Rd,s}$	[Nm]	12,9	14,6

Material quality

Type	Material
HUS3- H,A,C,P,PS,I,I-Flex	Carbon steel, galvanized $\geq 5 \mu\text{m}$
HUS- HR,CR	Stainless steel, grade A4

Anchor dimensions

Type		HUS	HUS3								
		HR,CR	H	C	A	PL	P	PS	I	I-Flex	
Nominal length	l_s [mm]	40-70	40-120	40-70	35-55	60	40-80	40-60	35-55	55-195	
Threaded outer diameter	d_t [mm]	7,6		7,85							
Core diameter	d_k [mm]	5,4		5,85							
Shaft diameter	d_s [mm]	5,8		6,15							
Diameter of integrated washer	d_i [mm]	-	16,5	-	-		-	-	-	-	
Stressed section	A_s [mm ²]	22,9		26,9							

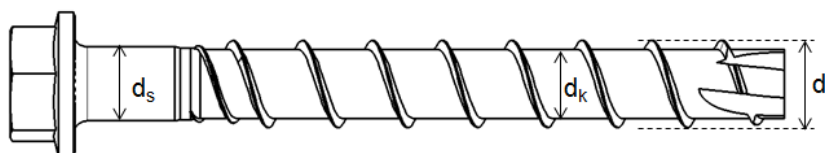

Special anchor dimensions

Type	HUS3-C			HUS-CR			HUS3-			
	M6	M8	M10	M6	M8	M10	PL	P	PS	
Countersunk height	h_c [mm]	4,0	6,3	6,9	4,3	6,3	7,0	-	-	-
Diameter of the countersunk	d_c [mm]	11,5	18	21	11,5	18	21	-	-	-
Pan head diameter	d_p [mm]	-	-	-	-	-	-	21,8	17,6	13,3

Head configuration

Type	Head		
HUS3-H 6	Hexagonal head		
HUS-HR 6	Hexagonal head		
HUS3-C 6	Countersunk head		
HUS-CR 6	Countersunk head		
HUS3-A 6	External thread		
HUS3-PL	Pan head (large)		
HUS3-P	Pan head		
HUS3-PS 6	Pan head (small)		
HUS3-I 6	Internal thread		
HUS3-I Flex 6	External thread		

Setting information

Setting details

Type		[mm]	HUS		HUS3						
			HR	CR	H	C	A	P	PL	PS	I
Nominal diameter of drill bit	d_0	[mm]	6								
Cutting diameter of drill bit	$d_{cut} \leq$	[mm]	6,40								
Clearance hole diameter	d_f	[mm]	9								
Wrench size	SW	[mm]	13	-	13	-	13	-	-	13	13
Installation torque	T_{inst}	[mm]	- ¹⁾	- ¹⁾	18						
Depth of drill hole in floor/wall position	$h_1 \geq$	[mm]	45 mm								
Depth of drill hole in ceiling position	$h_1 \geq$	[mm]	38 mm								

1) Hand setting in concrete base material not allowed (machine setting only).

Setting parameters

Type		[mm]	HUS-HR, CR HUS3-H, PL, P, PS, I, I-Flex, A, C
Minimum base material	h_{min}	[mm]	80
Minimum spacing	s_{min}	[mm]	35
Minimum edge distance	c_{min}	[mm]	35(80) ¹⁾
Critical spacing	s_{cr}	[mm]	3 h_{ef}
Critical edge distance	c_{cr}	[mm]	1,5 h_{ef}

1) For spacing (edge distance) smaller than critical spacing (critical edge distance) the design loads have to be reduced (see system design resistance).

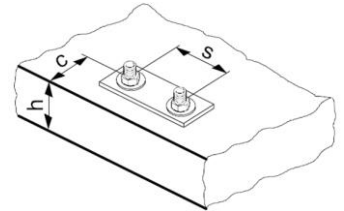

Screw length and maximum thickness of fixture

Fastener size		6									
Type	Nominal embedment depth [mm]	HUS		HUS3							
		HR	CR	H	C	A	PL	P	PS	I	I-
Length of screw [mm]		h_{nom}									
		Thickness of fixture [mm] t_{fix}									
35		-	-	-	-	0	-	-	-	0	-
40		-	5	5	5	-	-	5	5	-	-
45		10	-	-	-	-	-	-	-	-	-
55		-	-	-	-	20	-	-	-	20	20
60		25	25	25	25	-	25	25	25	-	-
70		35	35	-	35	-	-	-	-	-	-
80		-	-	45	-	-	-	45	-	-	-
100		-	-	65	-	-	-	-	-	-	-
120		-	-	85	-	-	-	-	-	-	-
135		-	-	-	-	-	-	-	-	-	100
155		-	-	-	-	-	-	-	-	-	120
175		-	-	-	-	-	-	-	-	-	140
195		-	-	-	-	-	-	-	-	-	160

Installation equipment

Type	HUS		HUS3									
	HR	CR	H	C	A	PL	P	PS	I	I-Flex		
Torx size	TX	-	-	T30	T30	T30	-	T30	T30	T30	-	-
Rotary hammer	TE 6 – TE 7											
Drill bit	TE-CX 6											
Wrench size (H, A, I-type)	SW	[mm]	13	-	13	-	13	-	-	-	13	13
Socket wrench insert (H, A, I-type)	S-NSD 13 ½ (L)											
Impact screw driver	T_{inst}	[mm]	Hilti SIW 14-A /Hilti SIW 22-A									

Setting parameters

Type			HUS-HR, CR HUS3-H, PL, P, PS, I, I-Flex, A, C
Minimum base material	h_{min}	[mm]	80
Minimum spacing	s_{min}	[mm]	35
Minimum edge distance	c_{min}	[mm]	35(80) ¹⁾
Critical spacing	s_{cr}	[mm]	3 h_{ef}
Critical edge distance	c_{cr}	[mm]	1,5 h_{ef}

2) For spacing (edge distance) smaller than critical spacing (critical edge distance) the design loads have to be reduced (see system design resistance).

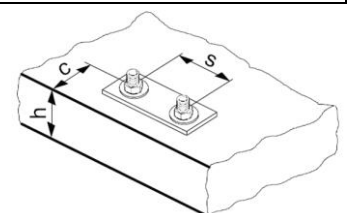

Setting instructions

*For detailed information on installation see instruction for use given with the package of the product

Setting instruction for HUS-HR,CR

1. Drill hole with the drill bit

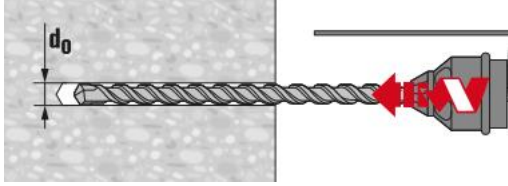

2. Clean hole

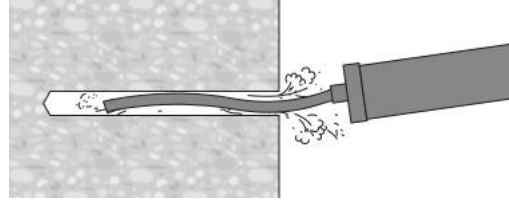

3. Installing the anchor by impact screw driver

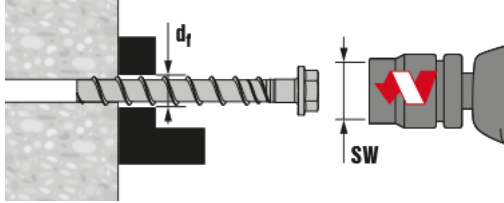

4. Checking

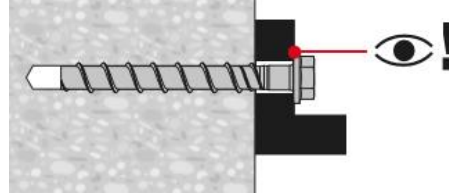

Setting instruction for HUS3-H, C, I, I-Flex, A, P, PS

1. Drill hole with drill bit

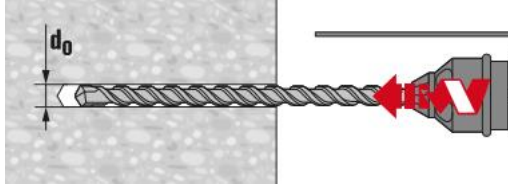

2. Clean hole

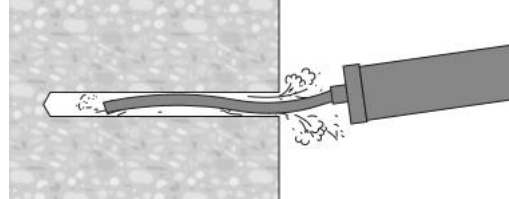

3. Installing the anchor by impact screw driver

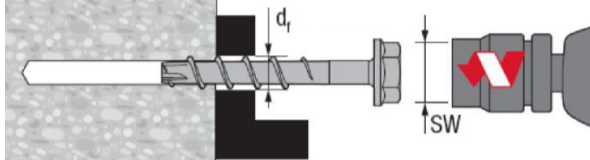

4. Checking

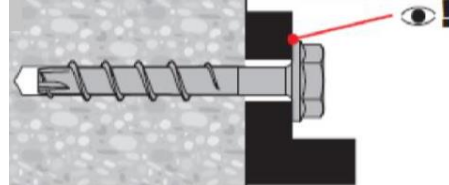

The anchor can be adjusted max. two times.

The total allowed thickness of shims added during the adjustment process is 10 mm.

The final embedment depth after adjustment process must be larger or equal than h_{nom2} or h_{nom3} .

Basic loading data for redundant fastening in prestressed hollow core slabs

All data in this section applies to:

- Correct anchor setting (See setting instruction)
- No edge distance and spacing influence
- Ratio core width/web thickness $w/e \leq 4,2$
- Concrete C 30/37 to C50/56
- Data for size 6 is according to ETA-10/0005
- Data for size 8 and 10 is according to Hilti technical data

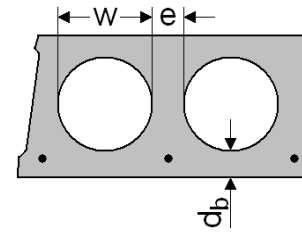

Requirements for redundant fastening

The definition of redundant fastening according to Member States is given in the EAD 330747 § 1.2.1. In Absence of a definition by a Member State the following default values may be taken.

Minimum number of fixing points	Minimum number of anchors per fixing point	Maximum design load of action N_{sd} per fixing point ^{a)}
3	1	2 kN
4	1	3 kN

a) The value for maximum design load of actions per fastening point N_{sd} is valid in general that means all fastening points are considered in the design of the redundant structural system. The value N_{sd} may be increased if the failure of one (=most unfavourable) fixing point is taken into account in the design (serviceability and ultimate limit state) of the structural system e.g. suspended ceiling.

Characteristic resistance for all load directions

Type	HUS-HR,CR 6x40, 6x45		HUS-HR, CR 6x60, 6x70			HUS3-H, PL, P, PS, I, I-Flex, A, C 6 all lengths				
	d_b [mm]		≥ 25	≥ 30	≥ 25	≥ 30	≥ 35	≥ 25	≥ 30	≥ 35
Bottom flange thickness	d_b [mm]		≥ 25	≥ 30	≥ 25	≥ 30	≥ 35	≥ 25	≥ 30	≥ 35
All load directions	F_{Rk} [kN]		1,0	2,0	1,0	2,0	3,0	1,0	2,0	3,0

Design resistance for all load directions

Type	HUS-HR,CR 6x40, 6x45		HUS-HR, CR 6x60, 6x70			HUS3-H, PL, P, PS, I, I-Flex, A, C 6 all lengths				
	d_b [mm]		≥ 25	≥ 30	≥ 25	≥ 30	≥ 35	≥ 25	≥ 30	≥ 35
Bottom flange thickness	d_b [mm]		≥ 25	≥ 30	≥ 25	≥ 30	≥ 35	≥ 25	≥ 30	≥ 35
All load directions	F_{Rd} [kN]		0,7	1,3	0,7	1,3	2,0	0,7	1,3	2,0

Recommended load for all load directions^{a)}

Type	HUS-HR,CR 6x40, 6x45		HUS-HR, CR 6x60, 6x70			HUS3-H, PL, P, PS, I, I-Flex, A, C 6 all lengths				
	d_b [mm]		≥ 25	≥ 30	≥ 25	≥ 30	≥ 35	≥ 25	≥ 30	≥ 35
Bottom flange thickness	d_b [mm]		≥ 25	≥ 30	≥ 25	≥ 30	≥ 35	≥ 25	≥ 30	≥ 35
All load directions	F_{Rec} [kN]		0,5	1,0	0,5	1,0	1,4	0,5	1,0	1,4

a) With overall partial safety factor for action $\gamma = 1,4$. The partial safety factors for action depend on the type of loading and shall be taken from national regulations.

Characteristic resistance for all load directions

Anchor size		8	10
Type		HUS3-C, H, HF	HUS3-C, H, HF
Bottom flange thickness	$d_b \geq$ [mm]	30	30
All load directions	F_{Rk} [kN]	2,0	2,0

Design resistance for all load directions

Anchor size		8	10
Type		HUS3-C, H, HF	HUS3-C, H, HF
Bottom flange thickness	$d_b \geq$ [mm]	30	30
All load directions	F_{Rd} [kN]	1,3	1,3

Recommended loads for all load directions

Anchor size		8	10
Type		HUS3-C, H, HF	HUS3-C, H, HF
Bottom flange thickness	$d_b \geq$ [mm]	30	30
All load directions ^{a)}	F_{Rec} [kN]	0,95	0,95

a) With overall partial safety factor for action $\gamma = 1,4$. The partial safety factors for action depend on the type of loading and shall be taken from national regulations.

Setting information

Setting details

Anchor size		6		
Type		HUS ¹⁾		HUS-HR, CR ²⁾ HUS3-H, PL, P, PS, I, I-Flex, A, C
		HR	CR	
Effective anchorage depth	h_{ef} [mm]	25		
Bottom flange thickness	$d_b \geq$ [mm]	25		
Nominal diameter of drill bit	d_0 [mm]	6		
Cutting diameter of drill bit	$d_{cut} \leq$ [mm]	6,4		
Nominal depth of drill hole ⁴⁾	$h_1 \geq$ [mm]	38		
Clearance hole diameter	d_f [mm]	9		
Distance between anchor and prestressing steel	$a_p \geq$ [mm]	50		
Core distance	$l_c \geq$ [mm]	100		
Pre-stressing steel distance	$l_p \geq$ [mm]	100		
Installation torque	T_{inst} [mm]	- ³⁾		18

1) Hilti Technical Data for embedment depth of 30 mm

2) ETA-10/0005 issue 2018-11-12

3) Hand setting in concrete base material not allowed (machine setting only)

4) Nominal depth of drill hole may be deeper than bottom flange thickness

Anchor size		8	
Type		HUS3-C, H, HF	HUS3-C, H, HF
Effective anchorage depth	h_{ef} [mm]	30	30
Bottom flange thickness	$d_b \geq$ [mm]	30	30
Nominal diameter of drill bit	d_0 [mm]	8	10
Cutting diameter of drill bit	$d_{cut} \leq$ [mm]	8,45	10,45
Nominal depth of drill hole ¹⁾	$h_1 \geq$ [mm]	40	40
Clearance hole diameter	d_f [mm]	12	14
Distance between anchor and prestressing steel	$a_p \geq$ [mm]	50	50
Core distance	$l_c \geq$ [mm]	100	100
Pre-stressing steel distance	$l_p \geq$ [mm]	100	100

1) Nominal depth of drill hole may be deeper than bottom flange thickness

Screw length and thickness of fixture used in precast pre-stressed hollow core slabs for size 6

Anchor size		6									
Type		HUS		HUS3							
		HR	CR	H	C	A	PL	P	PS	I	I-Flex
Length of screw [mm]	Nominal embedment depth [mm]	h_{nomd}									
		Thickness of fixture [mm] t_{fix}									
35		-	-	-	-	0	-	-	-	0	-
40		-	-	5	5	-	-	5	5	-	-
45		15	-	-	-	-	-	-	-	-	-
55		-	-	-	-	20	-	-	-	20	20
60		5-25	5-25	5-25	5-25	-	5-25	5-25	5-25	-	-
70		15-35	15-35	-	15-35	-	-	-	-	-	-
80		-	-	25-45	-	-	-	25-45	-	-	-
100		-	-	45-65	-	-	-	-	-	-	-
120		-	-	65-85	-	-	-	-	-	-	-
135		-	-	-	-	-	-	-	-	-	80-100
155		-	-	-	-	-	-	-	-	-	100-120
175		-	-	-	-	-	-	-	-	-	120-140
195		-	-	-	-	-	-	-	-	-	140-160

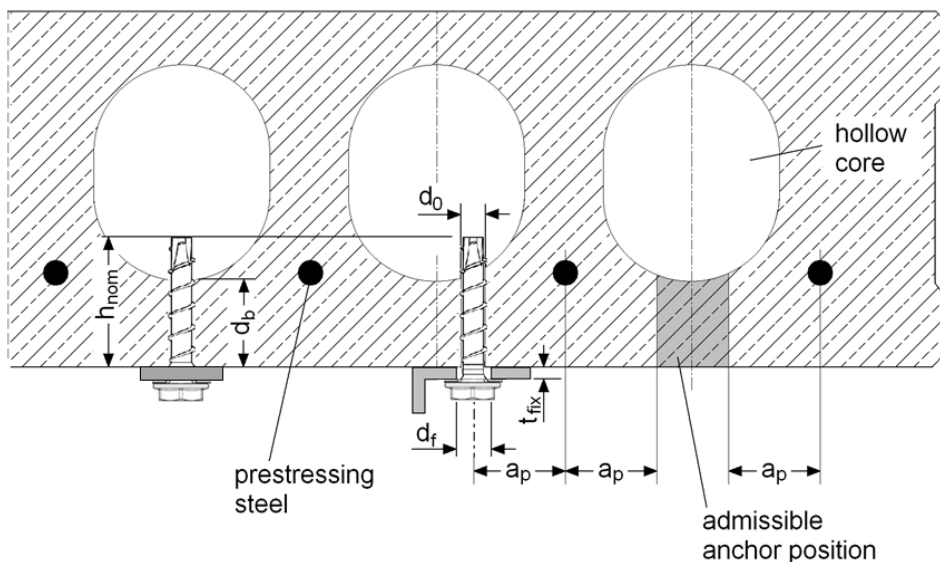

Screw length and thickness of fixture used in precast pre-stressed hollow core slabs for size 8

Anchor Type	Size [mm]	Length [mm]	d _b =30 [mm]		d _b =35 [mm]		d _b =40 [mm]		d _b =50 [mm]	
			t _{fix,min} [mm]	t _{fix,max} [mm]	t _{fix,min} [mm]	t _{fix,max} [mm]	t _{fix,min} [mm]	t _{fix,max} [mm]	t _{fix,min} [mm]	t _{fix,max} [mm]
HUS3-H	8	55	5	15	5	10	5	5	5	5
		65	5	25	5	20	5	15	5	5
		75	5	35	5	30	5	25	5	15
		85	15	45	15	40	15	35	15	25
		100	30	60	30	55	30	50	30	40
		120	50	80	50	75	50	70	50	60
		150	80	110	80	105	80	100	80	90
HUS3-HF	8	65	5	25	5	20	5	15	5	5
		75	5	35	5	30	5	25	5	15
		85	15	45	15	40	15	35	15	25
		100	30	60	30	55	30	50	30	40
HUS3-C	8	65	15	25	15	20	15	15	15	5
		75	15	35	15	30	15	25	15	15
		85	15	45	15	40	15	35	15	25
HUS3-H	10	60	5	15	5	10	5	5	5	5
		70	15	25	15	20	15	15	15	5
		80	5	35	5	30	5	25	5	15
		90	5	45	5	40	5	35	5	25
		100	15	55	15	50	15	45	15	35
		110	25	65	25	60	25	55	25	45
		130	45	85	45	80	45	75	45	65
		150	65	105	65	100	65	95	65	85
HUS3-HF	10	60	5	15	5	10	5	5	5	5
		80	5	35	5	30	5	25	5	15
		100	15	55	15	50	15	45	15	35
		110	25	65	25	60	25	55	25	45
HUS3-C	10	70	15	25	15	20	15	15	15	10
		90	15	45	15	40	15	35	15	25
		100	15	55	15	50	15	45	15	35

Chemical anchors

Screw

Mechanical anchors

Plastic/Light duty metal anchors

Insulation anchors

Anchor spacing and edge distance

Type			HUS-HR, CR HUS3-H, PL,P, PS, I, I-Flex, A, C
Minimum edge distance	$c_{min} \geq$	[mm]	100
Minimum anchor spacing	$s_{min} \geq$	[mm]	100
Minimum distance between anchor groups	$a_{min} \geq$	[mm]	100

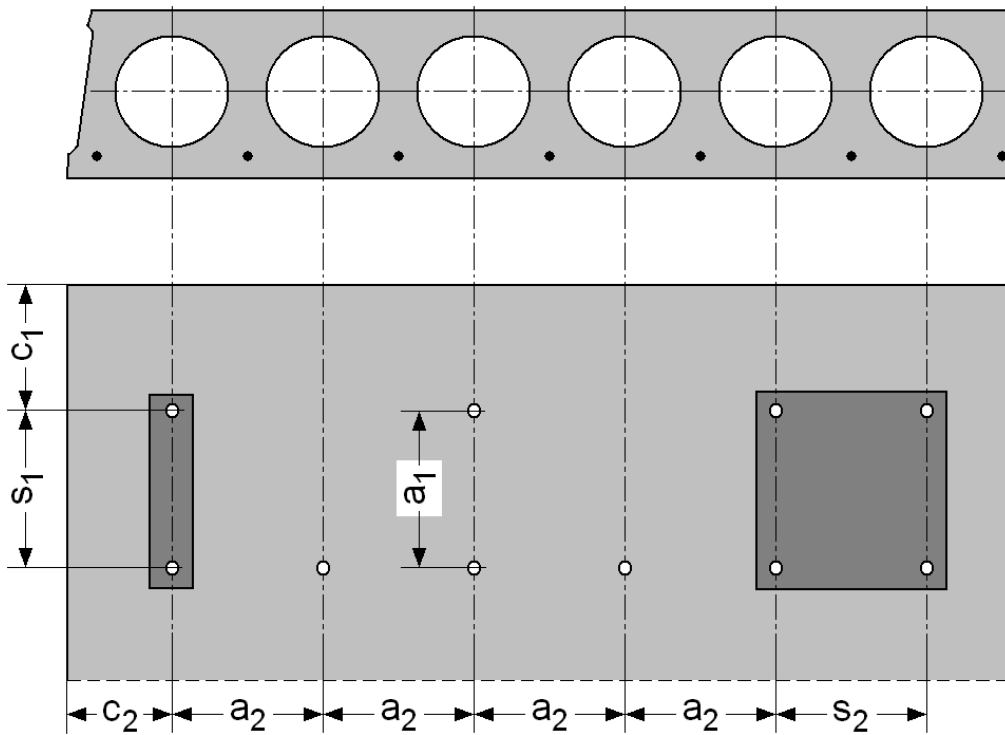

c_1, c_2 edge distance
 s_1, s_2 Anchor spacing
 a_1, a_2 Distances between anchor groups

Setting instructions

*For detailed information on installation see instruction for use given with the package of the product

Installation in hollow core slabs

1. Checking the anchor with tube Hilti HSB

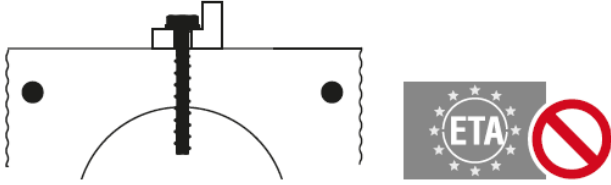

2. Positioning pre-stressed steel



3. Marking pre-stressed steel position

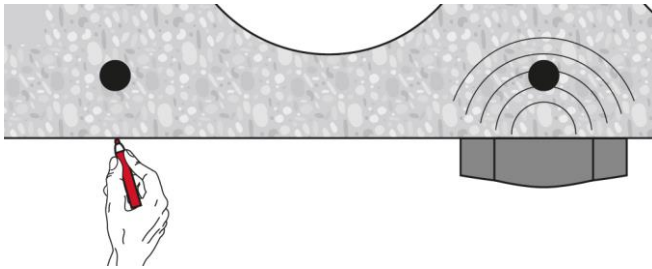

4. Marking pre-stressed steel position

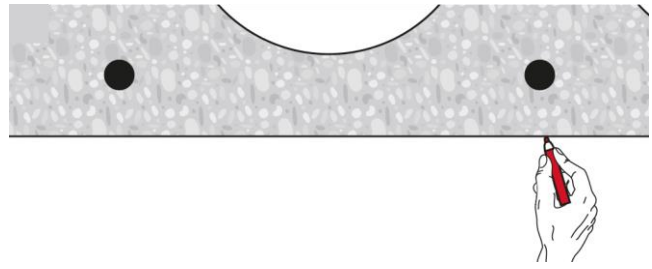

5. Drilling

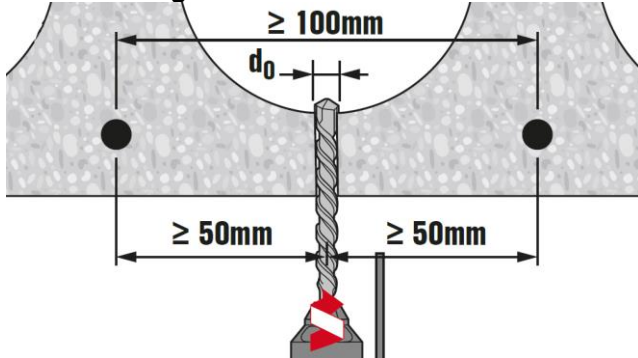

6. Setting the anchor

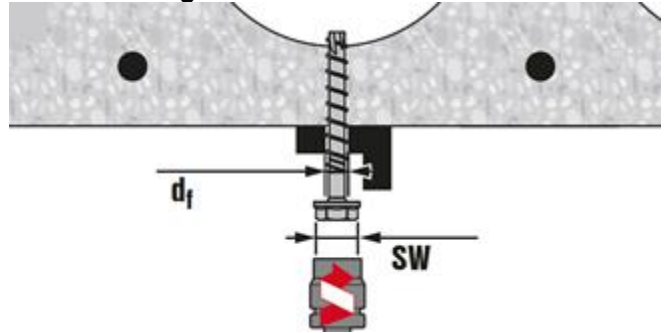

7. Setting the anchor

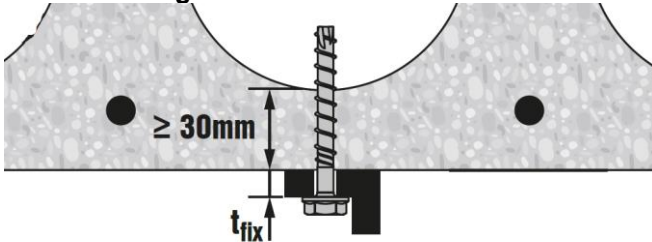

8. Checking

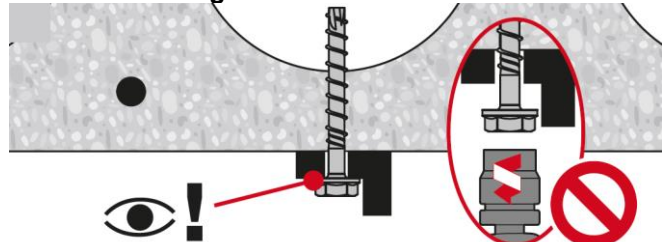

Chemical anchors

Screw

Mechanical anchors

Plastic/Light duty metal anchors

Insulation anchors

HUS-HR / HUS-CR Screw anchor

Ultimate performance screw anchor



Chemical anchors





Screw



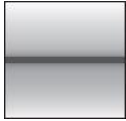
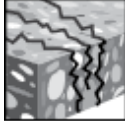

Mechanical anchors

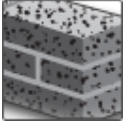
Plastic/Light duty metal anchors

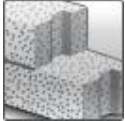
Insulation anchors

Anchor version	Benefits
 <p>HUS-H (10)</p>	<ul style="list-style-type: none"> - High productivity- less drilling and fewer operations than with conventional anchors - ETA approval for cracked and non-cracked concrete - ETA approval for Seismic C1 - Technical data for reusability in fresh concrete ($f_{ck,cube} = 10/15/20 \text{ Nmm}^2$) for temporary applications
 <p>HUS-HR (6-14)</p>	
 <p>HUS-CR (8-14)</p>	

Base material	Load conditions
 Concrete (non-cracked)	 Static / quasi-static
 Concrete (cracked)	 Seismic ETA-C1
 Solid brick	 Fire resistance
 Autoclaved aerated concrete	

Installation conditions	Other information
 Small edge distance and spacing	 European Technical Assessment
	 CE conformity
	 Corrosion resistance
	 PROFIS design software

Approvals / certificates		
Description	Authority / Laboratory	No. / date of issue
European Technical Assessment	DIBt, Berlin	ETA-08/0307 / 2018-08-23
Fire test report	DIBt, Berlin	ETA-08/0307 / 2018-08-23
Fire test report ZTV – Tunel (EBA)	MFPA, Leipzig	PB III / 08-354 / 2008-11-27

a) All data given in this section according ETA-08/0307 issue 2018-08-23.

Static and quasi-static resistance (for a single anchor)

All data in this section applies to:

- Correct setting (See setting instruction)
- No edge distance and spacing influence
- Steel failure
- Minimum base material thickness
- Concrete C 20/25, $f_{ck,cube} = 25 \text{ N/mm}^2$

Effective anchorage depth for static

Anchor size		6	8			10			14			
Type	HUS-	HR,CR	HR,CR			HR,CR			H		HR	
Nominal anchorage depth h_{ef} [mm]		55	50 ^{a)}	60	80	60 ^{a)}	70	90	70	85	70	110

a) Hilti Technical Data for embedment depth

Characteristic resistance

Anchor size		6	8			10			14		
Type	HUS-	HR	HR, CR			HR, CR			HR		
Non-cracked concrete											
Tension N_{Rk}	[kN]	9,0	9,0 ^{a)}	12,0	16,0	12,0 ^{a)}	16,0	25,0	-	18,9	40,2
Shear V_{Rk}	[kN]	17,0	23,6 ^{a)}	26,0	26,0	31,4 ^{a)}	33,0	33,0	-	37,8	77,0
Cracked concrete											
Tension N_{Rk}	[kN]	5,0	5,0 ^{a)}	6,0	12,0	7,5 ^{a)}	9,0	16,0	-	12,0	25,0
Shear V_{Rk}	[kN]	16,3	16,9 ^{a)}	23,2	26,0	22,5 ^{a)}	28,6	33,0	-	27,0	57,4

a) Hilti Technical Data

Design resistance

Anchor size		6	8			10			14		
Type	HUS-	HR	HR, CR			HR, CR			HR		
Non-cracked concrete											
Tension N_{Rd}	[kN]	4,3	5,0 ^{a)}	6,7	8,9	6,7 ^{a)}	8,9	13,9	-	10,5	22,3
Shear V_{Rd}	[kN]	11,3	15,7 ^{a)}	17,3	17,3	21,0 ^{a)}	22,0	22,0	-	25,2	51,3
Cracked concrete											
Tension N_{Rd}	[kN]	2,4	2,8 ^{a)}	3,3	6,7	4,2 ^{a)}	5,0	8,9	-	6,7	13,9
Shear V_{Rd}	[kN]	10,9	11,2 ^{a)}	15,5	17,3	15,0 ^{a)}	19,0	22,0	-	18,0	38,3

a) Hilti Technical Data

Recommended loads^{b)}

Anchor size		6	8			10			14		
Type	HUS-	HR	HR, CR			HR, CR			HR		
Non-cracked concrete											
Tension N_{Rec}	[kN]	3,1	3,6 ^{a)}	4,8	6,3	4,8	6,3	9,9	-	7,5	16,0
Shear V_{Rec}	[kN]	8,1	11,2 ^{a)}	12,4	12,4	15,0	15,7	15,7	-	18,0	36,7
Cracked concrete											
Tension N_{Rec}	[kN]	1,7	2,0 ^{a)}	2,4	4,8	3,0	3,6	6,3	-	4,8	9,9
Shear V_{Rec}	[kN]	1,8	8,0 ^{a)}	11,0	12,4	10,7	13,6	15,7	-	12,9	27,3

a) Hilti Technical Data

b) With overall partial safety factor for action $\gamma = 1,4$. The partial safety factors for action depend on the type of loading and shall be taken from national regulations.

Seismic resistance

All data in this section applies to:

- Correct setting
- Seismic design according to TR045
- The following data are based on ETA-08/0307 issue 2015-08-27
- Concrete C20/25 to C50/60

Effective anchorage depth for seismic C1

Anchor size		8	10	14
Type	HUS-	HR, CR	HR, CR	HR
Nominal anchorage depth	h_{nom} [mm]	80	90	110

Characteristic resistance for seismic C1

Anchor size		8	10	14
Type	HUS-	HR, CR	HR, CR	HR
Characteristic tension to steel failure				
Characteristic resistance	$N_{Rk,s,seis}$ [kN]	34,0	52,6	102,2
Partial safety factor	$\gamma_{Ms,seis}$ [-]	1,4		
Characteristic pull-out resistance in cracked concrete C20/25 to C50/60				
Characteristic resistance	$N_{Rk,p,seis}$ [kN]	7,7	12,5	17,5
Partial safety factor	$\gamma_{Ms,seis}$ [-]	1,8		
Concrete cone resistance and splitting resistance				
Partial safety factor	$\gamma_{Ms,seis}$ [-]	1,8		

Characteristic resistance for seismic C1¹⁾

Anchor size		8	10	14
Type	HUS-	HR, CR	HR, CR	HR
Characteristic shear resistance to steel failure				
Characteristic resistance	$V_{Rk,s,seis}$ [kN]	11,1	17,9	53,9
Partial safety factor	$\gamma_{Ms,seis}$ [-]	1,5		
Concrete pryout resistance and concrete edge resistance				
Partial safety factor	$\gamma_{Mc,seis}$ [-]	1,5		

1) Reduction factor $\alpha_{gap} = 1,0$ when using the Hilti Dynamic Set.

Fire resistance

All data in this section applies to:

- Correct setting
- No edge distance and spacing influence
- Minimum base material thickness
- The following technical data are based on: ETA-08/0307 issue 2015-08-27

Nominal embedment depth for resistance to fire

Anchor size		6	8		10		14	
Type	HUS-	HR	HR		HR		HR	
Nominal anchorage depth	h_{nom} [mm]	55	60	80	70	90	70	110

Recommended resistance to fire

Anchor size		6	8		10		14		
Type	HUS-	HR	HR		HR		HR		
Steel failure for tension and shear load ($F_{Rec,s,fi} = N_{Rec,s,fi} = V_{Rec,s,fi}$)									
Recommended tensile and shear load	R30	$F_{Rec,s,fi}$ [kN]	4,9	9,3	5,0	18,5	41,7		
	R60	$F_{Rec,s,fi}$ [kN]	3,3	6,3	3,6	12,0	26,9		
	R90	$F_{Rec,s,fi}$ [kN]	1,8	3,2	2,2	5,4	12,2		
	R120	$F_{Rec,s,fi}$ [kN]	1,0	1,7	1,5	2,4	5,4		
	R30	$M^0_{Rec,s,fi}$ [kN]	4,0	8,2	6,3	19,4	65,6		
	R60	$M^0_{Rec,s,fi}$ [kN]	2,7	5,5	4,6	12,6	42,4		
	R90	$M^0_{Rec,s,fi}$ [kN]	1,4	2,8	2,8	5,7	19,2		
	R120	$M^0_{Rec,s,fi}$ [kN]	0,8	1,5	1,9	2,5	8,5		
Pull-out failure									
Recommended resistance	R30	$N_{Rec,p,fi}$ [kN]	1,3	1,5	3,0	2,3	4,0	3,0	6,3
	R60								
	R90								
	R120								
Concrete cone failure									
Edge distance	R30 to R120	$C_{cr,N}$ [mm]	$2h_{ef}$						
Spacing	R30 to R120	$S_{cr,N}$ [mm]	$4h_{ef}$						
Concrete pry-out failure									
	R30 to R120	k	[-]	1,5	2,0	2,0	2,0		

- a) The recommended loads under fire exposure include a safety factor for resistance under fire exposure $\gamma_{Ms,fire} = 1,0$ and the partial safety factor for action $\gamma_{Ms,fire} = 1,0$. The partial safety factors for action shall be taken from national regulations.

Materials

Mechanical properties

Anchor size		6	8	10	14
Type	HUS-	HR	HR, CR	HR, CR	HR
Nominal tensile strength f_{uk}	[N/mm ²]	1050	870	950	690
Yield strength f_{yk}	[N/mm ²]	900	745	815	590
Stressed cross-section A_s	[mm ²]	22,9	39	55,4	143,1
Moment of resistance W	[mm ³]	15	34	58	255
Design bending resistance $M^{0}_{Rd,s}$	[Nm]	19	36	66	193

Material quality

Part	Material
Hexagonal head concrete screw	Stainless steel (grade A4)

Anchor dimensions

Anchor size		6	8	10	14
Type	HUS-	HR	HR, CR	HR, CR	HR
Core diameter	d_k [mm]	5,4	7,05	8,4	12,6
Shaft diameter	d_s [mm]	7,6	10,1	12,3	16,6
Stressed section	A_s [mm ²]	22,9	39,0	55,4	143,1

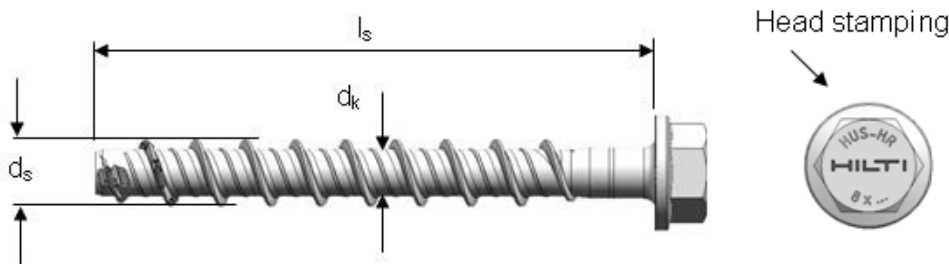

Screw length and thickness of fixture for HUS-HR

Anchor size		6	8	10	14			
Embedment depth	h_{nom1}, h_{nom2} [mm]	55	60	80	70	90	70	110
Thickness of fixture		t_{fix}	t_{fix1}	t_{fix2}	t_{fix1}	t_{fix2}	t_{fix1}	t_{fix2}
Length of screw [mm]	60	5	-	-	-	-	-	-
	65	-	5	-	-	-	-	-
	70	15	-	-	-	-	-	-
	75	-	15	-	5	5	10	-
	80	-	-	-	-	-	-	-
	85	-	25	5	15	-	-	-
	90	-	-	-	-	-	-	-
	95	-	35	15	25	5	-	-
	100	-	-	-	-	-	-	-
	105	-	45	25	35	15	-	-
	110	-	-	-	-	-	-	-
	115	-	-	-	45	25	-	-
	120	-	-	-	-	-	50	10
	130	-	-	-	-	-	-	-
135	-	-	-	-	-	65	25	
140	-	-	-	60	40	-	-	

Screw length and thickness of fixture for HUS-CR

Anchor size		8		10	
Embedment depth	h_{nom1}, h_{nom2} [mm]	60	80	70	90
Thickness of fixture		t_{fix1}	t_{fix2}	t_{fix1}	t_{fix2}
Length of screw [mm]	75	15	-	-	5
	80	-	-	-	-
	85	-	-	15	-
	90	-	-	-	-
	95	35	15	-	-
	100	-	-	-	-
	105	45	25	35	15

Setting information

Setting details

Anchor size		6	8			10			14		
Type	HUS-	HR	HR, CR ^{a)}			HR, CR ^{a)}			HR		
Nominal anchorage depth	h_{nom} [mm]	55	50	60	80	60	70	90	70	110	
Effective anchorage depth	h_{ef} [mm]	45	38	47	64	46	54	71	52	86	
Nominal diameter of drill bit	d_o [mm]	6	8			10			14		
Cutting diameter of drill bit	d_{cut} [mm]	6,4	8,45			10,45			14,5		
Clearance hole diameter	d_f [mm]	9	12			14			18		
Depth of drill hole	h_1 [mm]	65	60	70	90	70	80	100	80	120	
Wrench size	SW [mm]	13	13			15			21		
Diameter of countersunk	d_h [mm]	-	-			21			-		
Installation torque	Concrete	T_{inst} [Nm]	- ^{a)}	35	- ^{a)}	- ^{a)}	45 ^{c)}			65	
	Solid m, Mz 12	T_{inst} [Nm]	10	- ^{b)}	16	16	- ^{b)}	20	20	- ^{b)}	- ^{b)}
	Solid m, KS 12	T_{inst} [Nm]	10	- ^{b)}	16	16	- ^{b)}	20	20	- ^{b)}	- ^{b)}
	Aerated	T_{inst} [Nm]	4	- ^{b)}	8	8	- ^{b)}	10	10	- ^{b)}	- ^{b)}

a) Hand setting in concrete base material not allowed (machine setting only)

b) Hilti does not recommend this setting process for this application.

c) Installation torque refer to HUS-HR only

HUS-HR (hexagonal head) 6, 8, 10 and 14

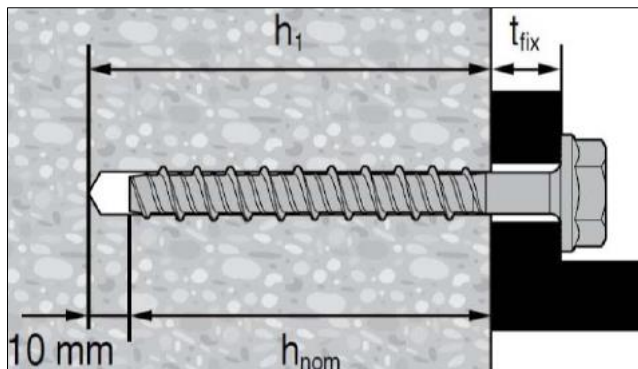

HUS-CR (countersunk) 8 and 10

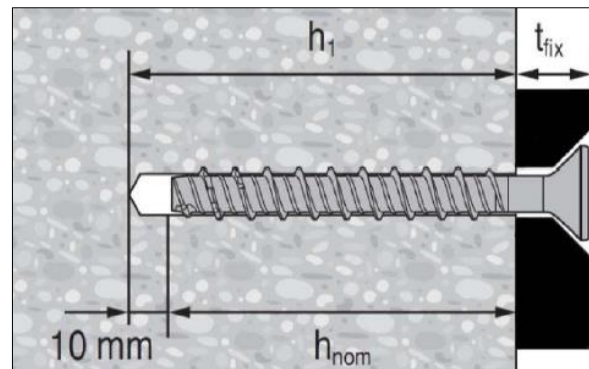

Installation equipment

Anchor size		6	8	10	14
Type	HUS-	HR	HR, CR	HR, CR	HR
Rotary hammer	TE 2 – TE 30				
Drill bit		TE-C3X 6/17	TE-C3X 8/17	TE-C3X 10/22	TE-C3X 14/22
Socket wrench insert		S-NSD 13 ½	S-NSD 13 ½	S-NSD 15 ½	S-NSD 21 ½
Torx (CR type only)		-	S-SY TX 45	S-SY TX 50	-
Impact screw driver		Hilti SIW 14-A, 22-A	Hilti SIW 22 T-A		

Setting parameters

Anchor size		6	8		10			14		
Type	HUS-	HR	HR, CR ^{a)}		HR, CR ^{a)}			HR		
Nominal anchorage depth	h_{nom} [mm]	55	50	60	80	60	70	90	70	110
Minimum base material	h_{min} [mm]	100	100	100	120	120	120	140	140	160
Minimum spacing	s_{min} [mm]	35	45	45	50	50	50	50	50	60
Minimum edge distance	c_{min} [mm]	35	45	45	50	50	50	50	50	60
Critical spacing for splitting	$s_{cr,sp}$ [mm]	135	114	114	192	166	194	256	187	310
Critical edge distance for	$c_{cr,sp}$ [mm]	68	57	71	96	83	97	128	94	155
Critical spacing for concrete	$s_{cr,N}$ [mm]	135	114	114	192	166	194	256	187	310
Critical edge distance for	$c_{cr,N}$ [mm]	68	57	71	96	83	97	128	94	155

For spacing (edge distance) smaller than critical spacing (critical edge distance) the design loads have to be reduced (see system design resistance).

Critical spacing and critical edge distance for splitting failure apply only for non-cracked concrete. For cracked concrete only the critical spacing and critical edge distance for concrete cone failure are decisive.

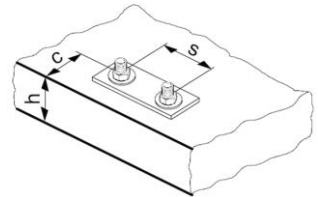

Setting instructions

*For detailed information on installation see instruction for use given with the package of the product

Setting instruction	
<p>1. Make a cylinder hole</p>	<p>2. Clean the borehole</p>
<p>3. Install the screw anchor by impact screw driver</p>	<p>4. Ensure that the fixture is caught</p>

Basic loading data (for a single anchor) in solid masonry units



All data in this section applies to:

- Load values valid for holes drilled with TE rotary hammers in hammering mod
- Correct anchor setting (see instruction for use, setting details)
- The core/material ratio may not exceed 15 % of a bed joint area
- The brim area around holes must be at least 70mm
- Edge distances, spacing and other influences, see below
- All data given in this section according to Hilti Technical Data

Nominal embedment depth

Anchor size		6	8	10
Type	HUS-	HR	HR	HR, CR
Nominal embedment depth	h_{nom} [mm]	55	60	70

Recommended loads for HUS-HR / HUS-CR

Anchor size			6	8	10
 Solid clay brick Mz 12/2,0 DIN 105 / EN 771-1 $f_b^{a)} \geq 12 \text{ N/mm}^2$	Tension N_{Rec} [kN]		0,9	1,0	1,1
	Shear N_{Rec} [kN]		1,4	2,0	2,3
 Solid sand-lime brick Mz 12/2,0 DIN 106/EN 771-2 $f_b^{a)} \geq 12 \text{ N/mm}^2$	Tension N_{Rec} [kN]		0,6	0,6	1,0
	Shear N_{Rec} [kN]		0,9	1,1	1,7
 Aerated concrete PPW 6-0,4 DIN 4165/EN 771-4 $f_b^{a)} \geq 6 \text{ N/mm}^2$	Tension N_{Rec} [kN]		0,2	0,2	0,4
	Shear N_{Rec} [kN]		0,4	0,4	0,9

Permissible anchor location in brick and block walls

Edge distance and spacing influence

- The technical data for HUS-HR anchors are reference loads for MZ 12 and KS 12. Due to the large variation of natural stone solid bricks, on site anchor testing is recommended to validate technical data
- The HUS-HR anchor was installed and tested in center of solid bricks as shown. The HUS-HR anchor was not tested in the mortar joint between solid bricks or in hollow bricks, however a load reduction is expected
- For brick walls where anchor position in brick can not be determined, 100 % anchor testing is recommended
- Distance to free edge free edge to solid masonry (Mz and KS) units $\geq 170\text{mm}$
- Distance to free edge free edge to solid masonry (autoclaved aerated gas concrete) units $\geq 170\text{mm}$
- The minimum distance to horizontal and vertical mortar joint (c_{min}) is started in drawing below
- Minimum anchor spacing (s_{min}) in one brick/block is $\geq 2 \cdot c_{min}$

Limits

- Applied load to individual bricks may not exceed 1,0 kN without compression or 1,4 kN with compression
- All data is for multiple use for non-structural applications
- Plaster, graveling, lining or levelling courses are regarded as non-bearing and may not be taken into account for the calculation of embedment depth

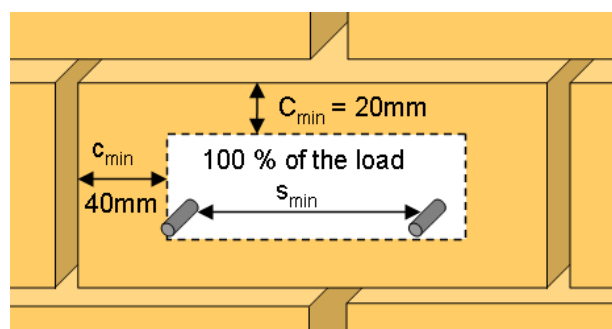

HUS-V Screw anchors

Economical screw anchor with hex head

Anchor version



HUS-V (8-10)

Benefits

- High productivity- less drilling and fewer operations than with conventional anchors
- Suitable for cracked and non-cracked concrete C20/25
- Technical data for cracked and non-cracked concrete
- Technical data for reusability in fresh concrete ($f_{ck,cube} = 10/15/20 \text{ Nmm}^2$) for temporary applications
- Two embedment depths for maximum design flexibility

Base material

Installation conditions



Concrete (non-cracked)

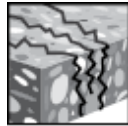

Concrete (cracked)



Tensile zone

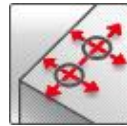

Small edge distance and spacing

Basic loading data (for a single anchor)

All data in this section applies to:

- Correct setting (See setting instruction)
- No edge distance and spacing influence
- Steel failure
- Minimum base material thickness
- Concrete C 20/25, $f_{ck,cube} = 25 \text{ N/mm}^2$
- Adjustment allowed during the installation for size 8 and 10, h_{nom2} only.

Effective anchorage depth for static

Anchor size		8		10	
Eff. Anchorage depth	h_{ef} [mm]	50	65	55	75

Mean ultimate resistance

Anchor size		8		10	
Non-cracked concrete					
Tension $N_{Ru,m}$	HUS-V [kN]	11,9	21,2	11,9	26,6
Shear $V_{Ru,m}$	HUS-V [kN]	16,4	16,7	18,6	20,5
Cracked concrete					
Tension $N_{Ru,m}$	HUS-V [kN]	5,3	11,9	8,0	21,2
Shear $V_{Ru,m}$	HUS-V [kN]	11,7	16,7	13,2	20,5

Characteristic resistance

Anchor size		8		10		
Non-cracked concrete						
Tension N_{Rk}	HUS-V	[kN]	9,0	16,0	9,0	20,0
Shear V_{Rk}	HUS-V	[kN]	12,3	15,9	14,0	19,5
Cracked concrete						
Tension N_{Rk}	HUS-V	[kN]	4,0	9,0	6,0	16,0
Shear V_{Rk}	HUS-V	[kN]	8,8	15,9	10,0	19,5

Design resistance

Anchor size		8		10		
Non-cracked concrete						
Tension N_{Rd}	HUS-V	[kN]	5,0	8,9	5,0	9,5
Shear V_{Rd}	HUS-V	[kN]	6,9	10,6	7,8	13,0
Cracked concrete						
Tension N_{Rd}	HUS-V	[kN]	2,2	5,0	3,3	7,5
Shear V_{Rd}	HUS-V	[kN]	4,9	10,9	5,5	13,0

Recommended loads^{a)}

Anchor size		8		10		
Non-cracked concrete						
Tension N_{Rec}	HUS-V	[kN]	3,6	6,3	3,6	6,8
Shear V_{Rec}	HUS-V	[kN]	4,9	7,6	5,6	9,3
Cracked concrete						
Tension N_{Rec}	HUS-V	[kN]	1,6	3,6	2,4	5,4
Shear V_{Rec}	HUS-V	[kN]	3,5	7,6	4,0	9,3

a) With overall partial safety factor for action $\gamma = 1,4$. The partial safety factors for action depend on the type of loading and shall be taken from national regulations.

Materials

Mechanical properties

Anchor size		8		10	
Nominal tensile strength f_{uk}		[N/mm ²]	880		715
Yield strength f_{yk}		[N/mm ²]	755		610
Stressed cross-section A_s		[mm ²]	36,6		59,4
Moment of resistance W		[mm ³]	35		65
Characteristic bending resistance $M^{0}_{Rk,s}$		[Nm]	37,1		55,5

Material quality

Part	Material
HUS-V	Carbon steel; Galvanized $\geq 5 \mu\text{m}$

Anchor dimensions

Anchor size		8		10	
Threaded outer diameter	d_t	[mm]	10,6		12,65
Core diameter	d_k	[mm]	7,1		8,7
Shaft diameter	d_s	[mm]	8,45		10,55
Stressed section	A_s	[mm ²]	36,6		59,4

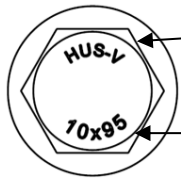
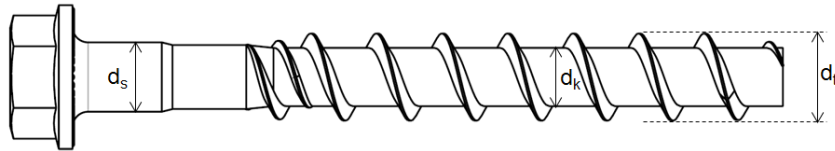

HUS-V : Hilti Universal Screw – hexagonal head

10x95 : screw diameter x screw length

Screw length and thickness of fixture for HUS-v (hex head)

Anchor size		8		10	
Nominal anchorage depth	h_{nom1}, h_{nom2} [mm]	50	65	55	75
Thickness of fixture		t_{fix1}	t_{fix2}	t_{fix1}	t_{fix2}
Length of anchor [mm]	55	5	-	-	-
	60	-	-	5	-
	75	25	15	-	-
	85	35	25	30	10
	95	45	35	40	20
	105	-	-	50	30

Setting information

Setting details

Anchor size		8		10	
Thread engagement length	h_{nom} [mm]	50	65	55	75
Nominal diameter of drill bit	d_0	8		10	
Cutting diameter of drill bit	$d_{cut} \leq$ [mm]	8,45		10,45	
Drill hole depth	$h_1 \geq$ [mm]	60	75	65	85
Maximum diameter of clearance hole in the fixture ²⁾	$d_f \leq$ [mm]	12		14	
Width across	SW [mm]	13		15	

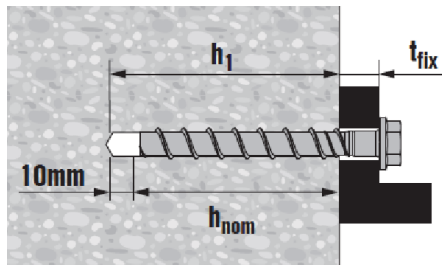

Installation equipment

Anchor size	8	10
Rotary hammer	TE 2 – TE 30	
Drill bit for concrete	CX 8	CX 10
Socket wrench insert	S-NSD 13 1/2	S-NSD 15 1/2
Tube for temporary application	HRG 8	HRG 10
Setting tool for concrete C12/15 to C50/60	SIW 22T-A – SIW 22-A	

Setting parameters

Anchor size		8		10	
Nominal anchorage depth	h_{nom} [mm]	50	65	55	75
Effective anchorage depth	h_{ef} [mm]	39,1	51,9	42,5	59,5
Minimum base material thickness	h_{min} [mm]	100	110	100	130
Minimum spacing	s_{min} [mm]	40	50	50	50
Minimum edge distance	c_{min} [mm]	50	50	50	50
Critical spacing for splitting failure	$s_{cr,sp}$ [mm]	117,3	140	130	180
Critical edge distance for splitting failure	$c_{cr,sp}$ [mm]	58,65	70	65	90
Critical spacing for concrete cone failure	$s_{cr,N}$ [mm]	117,3	177,3	127,5	178,5
Critical edge distance for concrete cone failure	$c_{cr,sp}$ [mm]	58,65	88,65	63,75	89,25

For spacing (edge distance) smaller than critical spacing (critical edge distance) the design loads have to be reduced.

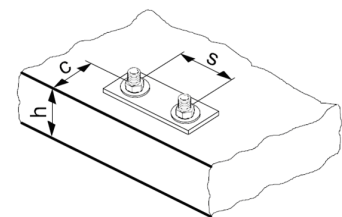



Setting instructions





*For detailed information on installation see instruction for use given with the package of the product

Setting instruction	
<p>1. Make a cylinder hole</p>	<p>2. Clean the borehole</p>
<p>3. Install the screw anchor by impact screw driver</p>	<p>4. Ensure that the fixture is caught</p>

HUS 6 / HUS-S 6 Screw anchor

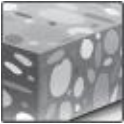
Everyday standard screw anchor

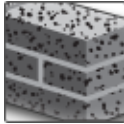
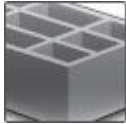
Anchor version		Benefits
	HUS 6 (6)	- Quick and easy setting - Low expansion forces in base materials
	HUS-S 6 (6)	- Through fastening - Removable

Base material	Load conditions
 Concrete (non-cracked)  Concrete (cracked)  Solid brick  Hollow brick  Autoclaved aerated concrete	 Fire resistance

Installation conditions
 Small edge distance and spacing  Redundant fastening

Approvals / certificates

Description	Authority / Laboratory	No. / date of issue
Assessment report (fire)	warringtonfire	WF327804/A 2013-07-10

Basic loading data (for a single anchor)

All data in this section applies to:

- Correct setting (See setting instruction)
- No edge distance and spacing influence
- Concrete as specified in the table
- **Steel** failure
- Minimum base material thickness
- Concrete C 20/25, $f_{ck,cube} = 25 \text{ N/mm}^2$
- Applied loads to individual bricks/blocks without compression may not exceed 1,0 kN
- Applied loads to individual bricks/blocks with compression may not exceed 1,4 kN
- Data applies only to bricks/blocks, there is no test data available for loads in mortar joints. Hilti recommends at least 50% load reduction or on site testing, if the location of the anchor in relation to the joint can not be specified because of wall plaster or insulation.
- Plaster, gravelling, lining or levelling courses are regarded as non-bearing and may not be taken into account for calculation of embedment depth

Note:

When tightening the screw anchor in soft base materials and in hollow brick, care must be taken not to apply too much torque. If the screw anchor is over-tightened the fastening point is unusable for the HUS 6.

Base material		Solid masonry units		Autoclaved aerated concrete	
		Mz 12 Solid brick	KS 12 Solid lime block	PB6 Block	PB2 Block
Compressive strength	[N/mm ²]	12	12	6	2
Bulk density	[N/mm ²]	1,8	2,0	0,6	0,2
Format (length/width/height)	[mm]	240/175/113	240/175/113	-	-

Recommended loads^{e)}

Anchor size		6													
Anchor type		HUS 6													
Base material		Non-cracked concrete		Cracked concrete ^{a)}	Solid brick ^{b)} MZ 20		Lime block ^{b)} KS sand		Hollow Brick ^{b)} Hz 0.8/12		PB / PB4 ^{c)d)}		PB6 ^{c)}		
		h _{nom} [mm]	60	30	44	60	30	60	30	60	30	60	30	60	30
Nominal embed. depth	h _{nom} [mm]	34		44	44		44		64		64		64		
Edge distance	c ≥ [mm]	60	30	100	60	30	60	30	60	30	60	30	60	30	
Tension	N _{Rec} [kN]	1,0	1,0	0,5	0,2	0,2	1,0	1,0	0,1	0,1	0,2	0,2	0,2	0,2	
Shear	V _{Rec} [kN]	1,6	0,5	0,5	0,4	0,3	1,1	0,4	0,4	0,2	0,3	0,1	0,6	0,2	

a) Redundant fastening

b) Holes must be drilled using rotary action only (no hammering action)

c) Aerated concrete

d) No anchor hole drilling required in PB2/PB4 gas aerated concrete

e) With overall partial safety factor for action $\gamma = 1,4$. The partial safety factors for action depend on the type of loading and shall be taken from national regulations.

Materials

Mechanical properties

Anchor size	HUS 6 / HUS-S 6	
Nominal tensile strength f_{uk} [N/mm ²]	1000	
Yield strength f_{yk} [N/mm ²]	900	
Stressed cross-section A_s [mm ²]	5,2	
Moment of resistance W [mm ³]	13,8	
Design bending resistance $M^0_{Rk,s}$ [Nm]	11	

Material quality

Part	Material
Screw anchor	Carbon Steel,galvanized $\geq 5 \mu\text{m}$

Anchor dimensions

Anchor size	HUS 6		HUS-S 6	
Nominal length of screw l_s [mm]	35 - 220		100 - 220	
Core diameter d_k [mm]	5,3		5,3	
Shaft diameter d [mm]	7,5		7,5	

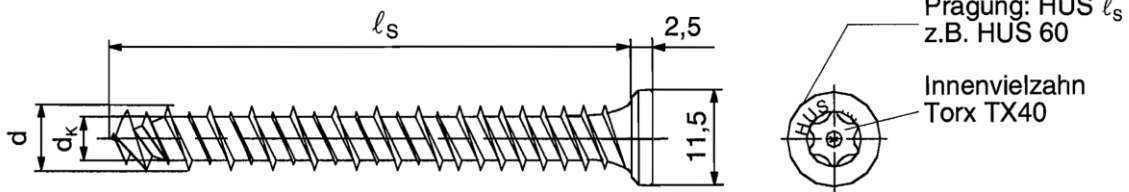

Head configuration HUS-S

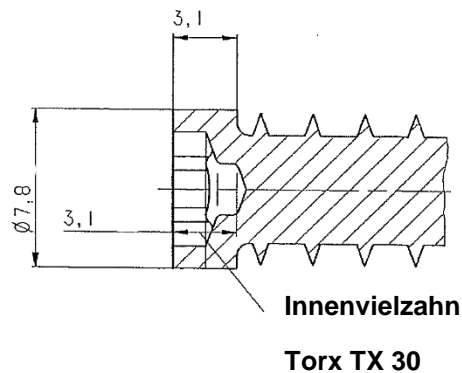

Setting information

Setting details

Anchor size	6				
Anchor type	HUS				
Base material	Concrete C20/25	Solid brick /Mz 20	Hollow Brick Hlz 0.8/12	PB / PB4 ^{c)}	PB6 ^{c)}
Nominal embed. depth h_{nom} [mm]	34	44	64	64	64
Nominal diameter of drill bit d_0 [mm]	6	6	6	-	6
Cutting diameter of drill bit d_{cut} [mm]	6,4	6,4	6,4	-	6,4
Minimum depth of drill hole $h_1 \geq$ [mm]	50	54 ^{b)}	64 ^{a)}	- ^{b)}	70
Diameter of clearance hole in the fixture to clamp a fixture $d_f \leq$ [mm]	8,5				
Diameter of clearance hole in the fixture for stand-off $d_f \leq$ [mm]	6,2				
Max. fastening thickness t_{fix} [mm]	$l_s - h_{nom}$				
Max. installation torque T_{inst} [mm]	10	4	2	2	2

- a) Holes must be drilled using rotary action only (no hammering action)
 b) No anchor hole drilling required in PB2/PB4 gas aerated concrete
 c) Aerated concrete

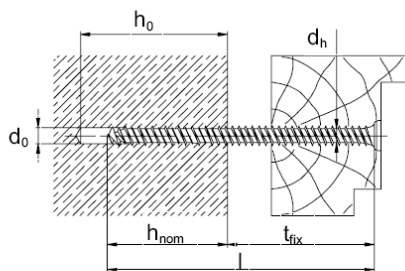

HUS

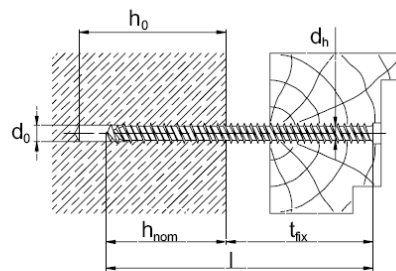

HUS-S

Installation equipment

Anchor size	HUS 6	HUS-S 6
Rotary hammer	TE 6 / TE 7	
Drill bit	TE-C3X 6/17	
Recommended setting tool	SID / SIW 121, SID / SIW 144, TKI 2500	
Accessories	S-B TXI 40 bit	S-B TXI 30 bit

Permissible anchor location in brick and block walls:

- Distance to free edge free edge to solid masonry (HLz and autoclaved aerated gas concrete) units ≥ 170 mm
- Distance to free edge free edge to solid masonry (Mz and KS) units ≥ 200 mm
- The minimum distance to horizontal and vertical mortar joint (c_{min}) is stated in the recommended load table.
- Data applies only to bricks/blocks, there is no test data available for loads in mortar joints. Hilti recommends at least a 50% load reduction or on site testing, if the location of the anchor in relation to the joint (see drawing) can not be specified because of wall plaster or insulation.
- Minimum anchor spacing (s_{min}) in one brick/block is $\geq 2 \cdot c_{min}$

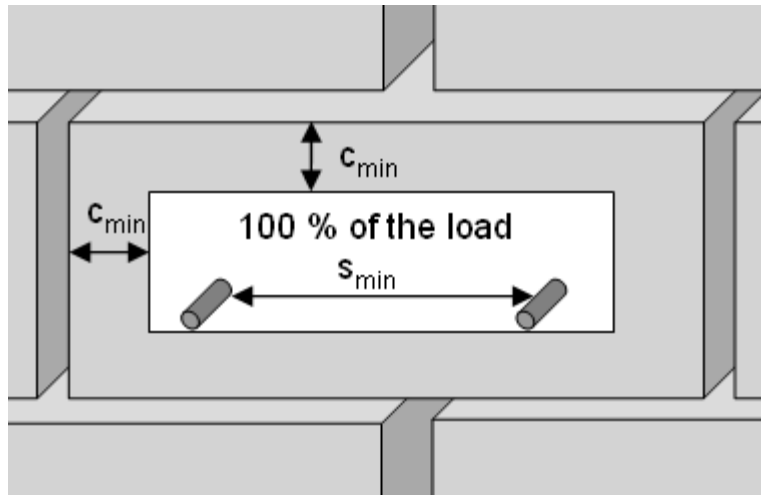

Setting instructions

*For detailed information on installation see instruction for use given with the package of the product

Setting instruction for HUS		
<p>1. Drill hole with drill bit</p>	<p>2. Clean the hole</p>	<p>3. Install the anchor with an electric screw driver</p>
Setting instruction for HUS-S		
<p>1. Drill hole with drill bit</p>	<p>2. Clean the hole</p>	<p>3. Install the anchor with an electric screwdriver.</p>

HKD Flush anchor

Everyday standard manual set flush anchor for single anchor applications



Chemical anchors

Flush





Mechanical anchors

Plastic/Light duty metal anchors

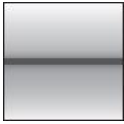
Insulation anchors

Anchor version	Benefits
 HKD (M8-M20)	<ul style="list-style-type: none"> - Simple and well proven - Approved, tested and confirmed by everyday jobsite experience - Reliable setting thanks to simple visual check - Versatile - For medium-duty fastening with bolts or threaded rods - Available in various materials and sizes for maximized coverage of possible applications
 HKD-S(R) (M6-M20)	
 HKD-E(R) (M6-M20)	

Base material	Load conditions
 Concrete (non-cracked)	 Static/ quasi-static

Installation conditions	Other information
 Hammer drilled holes	   

Approvals / certificates

Description	Authority / Laboratory	No. / date of issue
European Technical Assessment ^{a)}	CSTB, Marne-la-Vallée	ETA-02/0032 / 2015-01-07

a) All data given in this section according to ETA-02/0032, issue 2015-01-07.

Static resistance

All data in this section applies to:

- Correct setting (See setting instruction)
- No edge distance and spacing influence
- Concrete as specified in the table
- Steel failure
- Minimum base material thickness
- Concrete C 20/25, $f_{ck,cube} = 25 \text{ N/mm}^2$
- Screw or rod with steel grade 5.8 (carbon steel) and / or A4-70 (stainless steel)

Effective anchorage depth for static

Anchor size	M6	M8	M10	M12	M16	M8	M8	M10	M10	M12	M16	M20
Eff. anchorage depth range h_{ef} [mm]	25	25	25	25	30	30	40	30	40	50	65	80

Mean ultimate resistance

Anchor size		Hilti technical data				ETA-02/0032, issued 2015-01-07							
		M6x25	M8x25	M10x25	M12x25	M6x30	M8x30	M8x40	M10x30	M10x40	M12x50	M16x65	M20x80
Tension $N_{Ru,m}$	HKD	8,4	8,4	8,4	8,4	-	11,0	13,1	11,0	17,0	23,8	32,9	48,1
	HKD-S, HKD-E	8,2	-	-	-	10,6	10,8	16,6	10,8	16,6	23,3	34,5	47,1
	HKD-SR, HKD-ER	8,2	-	-	-	10,6	10,8	-	-	16,6	23,3	34,5	47,1
Shear $V_{Ru,m}$	HKD	5,5	6,9	6,9	6,9	-	9,4	10,1	11,0	12,2	20,1	37,1	53,9
	HKD-S, HKD-E	6,5	-	-	-	6,5	9,1	9,1	9,6	10,4	18,3	28,5	45,1
	HKD-SR, HKD-ER	8,3	-	-	-	7,0	10,9	-	-	13,7	24,3	41,7	66,3

Characteristic resistance

Anchor size		Hilti technical data				ETA-02/0032, issued 2015-01-07							
		M6x25	M8x25	M10x25	M12x25	M6x30	M8x30	M8x40	M10x30	M10x40	M12x50	M16x65	M20x80
Tension N_{Rk}	HKD	6,3	6,3	6,3	6,3	-	8,3	9,0	8,3	12,8	17,8	26,4	36,1
	HKD-S, HKD-E	6,3	-	-	-	8,3	8,3	9,0	8,3	12,8	17,8	26,4	36,1
	HKD-SR, HKD-ER	6,3	-	-	-	8,3	8,3	-	-	12,8	17,8	26,4	36,1
Shear V_{Rk}	HKD	5,0	6,3	6,3	6,3	-	8,6	9,2	10,0	11,0	18,3	33,8	49,0
	HKD-S, HKD-E	5,0	-	-	-	5,0	7,0	7,0	7,4	8,0	14,1	21,9	34,7
	HKD-SR, HKD-ER	6,2	-	-	-	6,4	8,4	-	-	10,5	18,7	32,1	51,0

Design resistance

Anchor size		Hilti technical data				ETA-02/0032, issued 2015-01-07							
		M6x25	M8x25	M10x25	M12x25	M6x30	M8x30	M8x40	M10x30	M10x40	M12x50	M16x65	M20x80
Tension N_{Rd}	HKD	4,2	4,2	4,2	4,2	-	5,5	6,0	5,5	8,5	11,9	17,6	24,0
	HKD-S, HKD-E	3,0	-	-	-	4,6	4,6	5,0	4,6	7,1	9,9	17,6	24,0
	HKD-SR, HKD-ER	3,0	-	-	-	4,6	4,6	-	-	7,1	9,9	17,6	24,0
Shear V_{Rd}	HKD	4,0	4,2	4,2	4,2	-	6,9	7,3	8,0	8,8	14,6	27,0	39,4
	HKD-S, HKD-E	3,9	-	-	-	3,9	5,5	5,5	5,9	6,4	11,3	17,5	27,8
	HKD-SR, HKD-ER	4,1	-	-	-	4,2	5,5	-	-	6,9	12,3	21,1	33,6

Recommended loads ^{a)}

Anchor size		Hilti technical data				ETA-02/0032, issued 2015-01-07							
		M6x25	M8x25	M10x25	M12x25	M6x30	M8x30	M8x40	M10x30	M10x40	M12x50	M16x65	M20x80
Tension N_{Rec}	HKD	3,0	3,0	3,0	3,0	-	3,9	4,3	3,9	6,1	8,5	12,6	17,2
	HKD-S, HKD-E [kN]	2,1	-	-	-	3,3	3,3	3,6	3,3	5,1	7,1	12,6	17,2
	HKD-SR, HKD-ER	2,1	-	-	-	3,3	3,3	-	-	5,1	7,1	12,6	17,2
Shear V_{Rd}	HKD	2,9	3,0	3,0	3,0	-	4,9	5,2	5,7	6,3	10,5	19,3	28,3
	HKD-S, HKD-E [kN]	2,8	-	-	-	2,8	3,9	4,2	3,9	4,6	8,1	12,5	19,8
	HKD-SR, HKD-ER	2,9	-	-	-	3,0	3,9	-	-	4,9	8,8	15,1	24,0

a) With overall partial safety factor for action $\gamma = 1,4$. The partial safety factors for action depend on the type of loading and shall be taken from national regulations.

Materials
Mechanical properties

Anchor size		M6	M8	M10	M12	M16	M20
Nominal tensile strength f_{uk}	HKD	570	570	570	570	640	590
	HKD-S, HKD-E [N/mm ²]	560	560	510	510	-	460
	HKD-SR, HKD-ER	540	540	540	540	-	540
Yield strength f_{yk}	HKD	460	460	460	480	510	470
	HKD-S, HKD-E [N/mm ²]	440	440	410	410	-	375
	HKD-SR, HKD-ER	355	355	355	355	-	355
Stressed cross-section A_s	HKD	20,7	26,7	32,7	60,1	105	167
	HKD-S, HKD-E [mm ²]	20,9	26,1	28,8	58,7	-	163
	HKD-SR, HKD-ER						
Moment of resistance W	HKD	32,3	54,6	82,9	184	431	850
	HKD-S, HKD-E [mm ³]	50	79	110	264	602	1191
	HKD-SR, HKD-ER						
Char. bending resistance for rod or bolt $M^0_{Rk,s}$	With 5.8 Gr. Steel	7,6	18,7	37,4	65,5	167	325
	HKD-SR HKD-ER with A4-70 [Nm]	11	26	52	92	187	454

Material quality

Part	Material	
Anchor body	HKD	Cold formed steel / galvanised to min. 5 μ m
	HKD-S, HKD-E	Steel Fe/Zn5 galvanised to min. 5 μ m
	HKD-SR, HKD-ER	Stainless steel, 1.4401, 1.4404, 1.4571
Expansion plug	HKD	Cold formed steel
	HKD-S, HKD-E	Cold formed steel
	HKD-SR, HKD-ER	Stainless steel, 1.4401, 1.4404, 1.4571

Anchor dimensions of HKD, HKD-S, HKD-E, HKD-SR, HKD-ER

Anchor size	Hilti technical data				ETA-02/0032, issued 2015-01-07								
	M6x25	M8x25	M10x25	M12x25	M6x30	M8x30	M8x40	M10x30	M10x40	M12x50	M16x65	M20x80	
Eff. anchorage depth h_{ef} [mm]	25	25	25	25	30	30	40	30	40	50	65	80	
Anchor diameter d_1 [mm]	7,9	9,95	11,9	14,9	8	9,95	9,95	11,8	11,95	14,9	19,75	24,75	
Plug diameter d_2 [mm]	5,1	6,35	8,1	9,7	5	6,5	6,35	8,2	8,2	10,3	13,8	16,4	
Plug length l_1 [mm]	10	7	7	7,2	15	12	16	12	16	20	29	30	

Anchor body

HKD

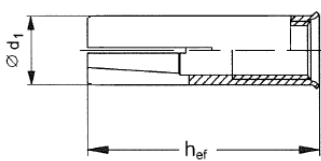

HKD-S and HKD-SR

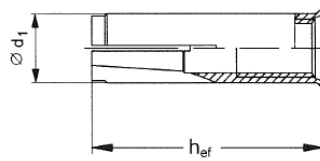

Expansion plugs

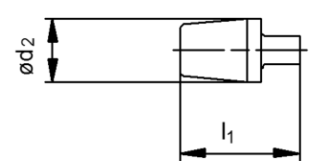
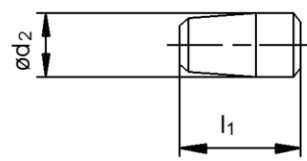

HKD-E and HKD ER

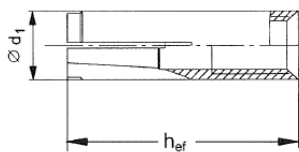

Setting information

Setting details

Anchor size	Hilti technical data				ETA-02/0032, issued 2015-01-07								
	M6x25	M8x25	M10x25	M12x25	M6x30	M8x30	M8x40	M10x30 ^{a)}	M10x40	M12x50	M16x65	M20x80	
Effective embedment depth h_{ef} [mm]	25	25	25	25	30	30	40	30	40	50	65	80	
Nominal diameter of drill bit d_o [mm]	8	10	12	15	8	10	10	12	12	15	20	25	
Cutting diameter of drill bit $d_{cut} \leq$ [mm]	8,45	10,5	12,5	15,5	8,45	10,5	10,5	12,5	12,5	15,5	20,5	25,5	
Depth of drill hole $h_1 \geq$ [mm]	27	27	27	27	32	33	43	33	43	54	70	85	
Screwing depth $l_{s,min}$ [mm]	6	8	10	12	6	8	8	10	10	12	16	20	
Thread engagement depth $l_{s,max}$ [mm]	12	11,5	12	12	12,5	14,5	17,5	12,7	18	23,5	30,5	42	
Diameter of clearance hole in the fixture $d_f \leq$ [mm]	7	9	12	14	7	9	9	12	12	14	18	22	
Max. torque moment T_{ins} [Nm]	4	8	15	35	4	8	8	15	15	35	60	100	

a) With anchor size M10x30 only threaded rod is to be used.

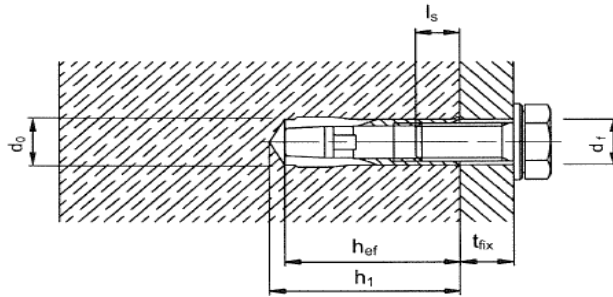

Installation equipment

Anchor size		M6	M8	M10	M10	M12	M16
Rotary hammer for setting		TE 1 – TE 3				TE 16 – TE 50	
Machine setting tool	HSD-M	6x25/30	8x25/30	10x25/30	10x40	12x50	16x65
Hand setting tool	HSD-G HSD-M	6x25/30	8x25/30	10x25/30	10x40	12x50	16x65
Other tools		hammer, torque wrench, blow up pump					

Setting parameters

Anchor size		Hilti technical data				ETA-02/0032, issued 2015-01-07							
		M6x25	M8x25	M10x25	M12x25	M6x30	M8x30	M8x40	M10x30	M10x40	M12x50	M16x65	M20x80
Minimum base material thickness	h_{min} [mm]	100	100	100	100	100	100	100	100	100	100	130	160
Minimum spacing and minimum edge distance HKD-S (R) / HKD-E (R)	s_{min} [mm]	60	60	60	60	60	60	80	60	80	125	130	160
	c_{min} [mm]	88	88	88	88	105	105	140	105	140	175	230	280
Minimum spacing HKD	s_{min} [mm]	80	80	80	80	60	60	80	60	80	125	130	160
	$c \geq$ [mm]	140	140	140	140	105	105	140	105	140	175	230	280
Minimum edge distance HKD	c_{min} [mm]	100	100	100	100	80	80	140	80	140	175	230	280
	$s \geq$ [mm]	150	150	150	150	120	120	80	120	80	125	130	160
Critical spacing and edge distance for splitting failure HKD	$s_{cr,sp}$ [mm]	200	200	200	200	210	210	280	210	280	350	455	560
	$c_{cr,N}$ [mm]	100	100	100	100	105	105	140	105	140	175	227	280
Critical spacing and edge distance for concrete cone failure HKD / HKDS-(R) / HKD-E(R)	$s_{cr,N}$ [mm]	80	80	80	80	90	90	120	90	120	150	195	240
	$c_{cr,N}$ [mm]	40	40	40	40	45	45	60	45	60	75	97	120
Critical spacing and edge distance for splitting failure HKD-S(R) / HKD-E(R)	$s_{cr,sp}$ [mm]	176	176	176	176	210	210	280	210	280	350	455	560
	$c_{cr,N}$ [mm]	88	88	88	88	105	105	140	105	140	175	227	280

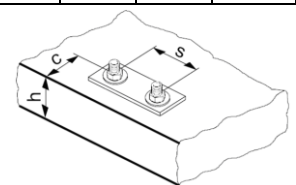
For spacing (edge distance) smaller than critical spacing (critical edge distance) the design loads have to be reduced.



Setting instruction

*For detailed information on installation see instruction for use given with the package of the product.

Setting instruction	
<p>1. Drilling</p>	<p>2. Cleaning</p>
<p>3. Inserting the anchor</p>	<p>4. Setting tools</p>
<p>5. Inserting the tools</p>	<p>6. Inserting the tools</p>
<p>7. Attaching the belonging washer</p>	

Chemical anchors

Flush

Mechanical anchors

Plastic/Light duty metal anchors

Insulation anchors

HKD Flush anchor

Everyday standard manual set flush anchor for redundant fastening applications





Chemical anchors





Flush



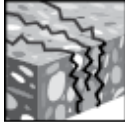

Mechanical anchors

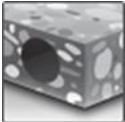
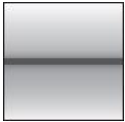
Plastic/Light duty metal anchors

Insulation anchors

Anchor version	Benefits
 HKD (M6-M16)	<ul style="list-style-type: none"> - Simple and well proven - Approved, tested and confirmed by everyday jobsite experience - Reliable setting thanks to simple visual check - Versatile - For medium-duty fastening with bolts or threaded rods - Available in various materials and sizes for maximized coverage of possible applications
 HKD-woL (M6-M16)	
 HKD-S(R) (M6-M12)	
 HKD-E(R) (M6-M12)	

Base material	Load conditions
 Concrete (non-cracked)	 Concrete (cracked)
 Redundant fastening	
 Pre-stressed hollow core slabs	
 Static/quasi-static	
 Fire resistance	
 Fire resistance	

Other information			
 European Technical Assessment	 CE conformity	 Sprinkler approved	 Corrosion resistance

Approvals / certificates

Description	Authority / Laboratory	No. / date of issue
European Technical Assessment ^{a)}	DIBt, Berlin	ETA-06/0047 / 2016-02-08
Fire test report	DIBt, Berlin	ETA-06/0047 / 2016-02-08
Assessment report fire	Warringtonfire	WF 327804/A / 2013-07-10

a) All data given in this section according to ETA-06/0047, issue 2016-02-08.

Static and quasi-static resistance for

All data in this section applies to:

- Correct setting (See setting instruction)
- No edge distance and spacing influence
- Minimum base material thickness
- Concrete C 20/25, $f_{ck,cube} = 25 \text{ N/mm}^2$
- Anchors in redundant fastening

Effective anchorage depth for static

Anchor size	M6	M6	M8	M8	M8	M10	M10	M10	M12	M12	M16
Eff. anchorage depth range h_{ef} [mm]	25	30	25	30	40	25	30	40	25	50	65

Characteristic resistance, all load directions

Anchor size			M6x25	M6x30	M8x25	M8x30	M8x40	M10x25	M10x30	M10x40	M12x25	M12x50	M16x65
Load F_{Rk}	HKD / HKD-woL	[kN]	2,0	-	3,0	5,0	5,0	4,0	5,0	7,5	4,0	9,0	16,0
	HKD-S/ HKD-E		-	3,0	-	3,0	5,0	-	4,0	6,0	-	6,0	-
	HKD-SR/ HKD-ER		-	3,0	-	3,0	-	-	-	6,0	-	6,0	-

Design resistance, all load directions

Anchor size			M6x25	M6x30	M8x25	M8x30	M8x40	M10x25	M10x30	M10x40	M12x25	M12x50	M16x65
Load F_{Rd}	HKD / HKD-woL	[kN]	1,3	-	2,0	2,8	3,3	2,2	3,3	5,0	2,7	6,0	10,7
	HKD-S/ HKD-E		-	2,0	-	2,0	3,3	-	2,7	4,0	-	4,0	-
	HKD-SR/ HKD-ER		-	2,0	-	2,0	-	-	-	4,0	-	4,0	-

Recommended loads ^{a)}, all load directions

Anchor size			M6x25	M6x30	M8x25	M8x30	M8x40	M10x25	M10x30	M10x40	M12x25	M12x50	M16x65
Load F_{Rec}	HKD / HKD-woL	[kN]	1,0	-	1,4	2,0	2,4	1,6	2,4	3,6	1,9	4,3	7,6
	HKD-S/ HKD-E		-	1,4	-	1,4	2,4	-	1,9	2,9	-	2,9	-
	HKD-SR/ HKD-ER		-	1,4	-	1,4	-	-	-	2,9	-	2,9	-

a) With overall partial safety factor for action $\gamma = 1,4$. The partial safety factors for action depend on the type of loading and shall be taken from national regulations.

Requirements for redundant fastening

The definition of redundant fastening according to Member States is given in the ETAG 001 Part six, Annex 1. In absence of a definition by a Member State the following default values may be taken.

Minimum number of fixing points	Minimum number of anchors per fixing point	Maximum design load of action N_{Sd} per fixing point ^{a)}
3	1	2 kN
4	1	3kN

a) The value for maximum design load of actions per fastening point N_{Sd} is valid in general that means all fastening points are considered in the design of the redundant structural system. The value N_{Sd} may be increased if the failure of one (=most unfavorable) fixing point is taken into account in the design (serviceability and ultimate limit state) of the structural system e.g. suspended ceiling.

Materials

Mechanical properties

Anchor size			M6	M8	M10	M10	M12
Nominal tensile strength	f_{uk}	HKV / HKD-woL	570	570	570	570	640
		HKD-S, HKD-E	560	560	510	510	-
		HKD-SR, HKD-ER	540	540	540	540	-
Yield strength	f_{yk}	HKV / HKD-woL	460	460	460	480	510
		HKD-S, HKD-E	440	440	410	410	-
		HKD-SR, HKD-ER	355	355	355	355	-
Stressed cross-section	A_s	HKV / HKD-woL	20,7	26,7	32,7	60,1	105
		HKD-S, HKD-E	20,9	26,1	28,8	58,7	-
		HKD-SR, HKD-ER					
Moment of resistance	W	HKV / HKD-woL	32,3	54,6	82,9	184	431
		HKD-S, HKD-E	50	79	110	264	-
		HKD-SR, HKD-ER					
Char. bending resistance for rod or bolt	$M^{0Rk,s}$	With 5.8 Gr. Steel	7,6	18,7	37,4	65,5	167
		HKD-SR	11	26	52	92	-
		HKD-ER with A4-70					

Material quality

Part	Material	
Anchor body	HKV / HKD-woL	Cold formed steel-galvanized to $\geq 5 \mu\text{m}$
	HKD-S, HKD-E	Steel Fe/Zn5, galvanized to $\geq 5 \mu\text{m}$
	HKD-SR, HKD-ER	Stainless steel, 1.4401, 1.4404, 1.4571 EN 10088-3:2014
Expansion plug	HKV / HKD-woL	Cold formed steel
	HKD-S, HKD-E	Cold formed steel
	HKD-SR, HKD-ER	Stainless steel, 1.4401, 1.4404, 1.4571 EN 10088-3:2014

Anchor dimensions of HKD, HKD-S, HKD-E, HKD-SR, HKD-ER

Anchor size			M6x25	M8x25	M10x25	M12x25	M6x30	M8x30	M8x40	M10x30	M10x40	M12x50	M16x65
Anchor length	l_G	[mm]	25	30	25	30	40	25	30	40	25	50	65
Anchor diameter	\varnothing_{d1}	[mm]	7,9	8	9,95	9,95	9,95	11,9	11,8	11,95	14,9	14,9	19,75
Plug diameter	\varnothing_{d2}	[mm]	5,1	5	6,35	6,5	6,35	8,1	8,2	8,2	9,7	10,3	13,8
Plug length	l_1	[mm]	10	15	7	12	16	7	12	16	7,2	20	29

Anchor body

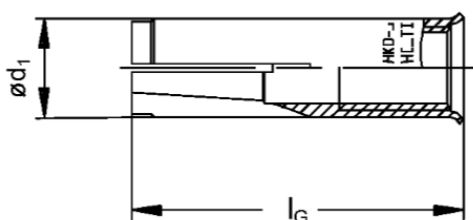

Expansions plugs

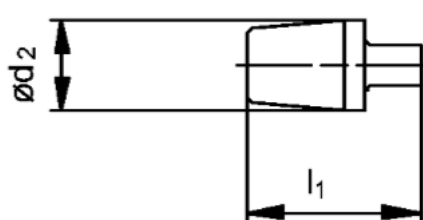

Setting information

Setting details

Anchor size		M6x25	M6x30	M8x25 ^{a)}	M8x30	M8x40	M10x25 ^{a)}	M10x30 ^{a)}	M10x40	M12x25 ^{a)}	M12x50	M16x65
Effective anchorage depth	h_{ef} [mm]	25	30	25	30	40	25	30	40	25	50	65
Nominal diameter of drill bit	d_0 [mm]	8	8	10	10	10	12	12	12	15	15	20
Thread diameter	d [mm]	6	6	8	8	8	10	10	10	12	12	16
Depth of drill hole	h_1 [mm]	27	32	27	33	43	27	33	43	27	54	70
Diameter of clearance hole in the fixture	d_f [mm]	7	7	9	9	9	12	12	12	14	14	18
Torque moment	T_{inst} [mm]	4	4	8	8	8	15	15	15	35	35	60
Screwing depth	$l_{s,min}$ [mm]	6	6	8	8	8	10	10	10	12	12	16
	$l_{s,max}$ [mm]	12	12,5	11,5	14,5	17,5	12	12,7	18	12	23,5	30,5

a) With anchor size M8x25, M10x25, M10x30 and M12x25 only threaded rod are to be used.

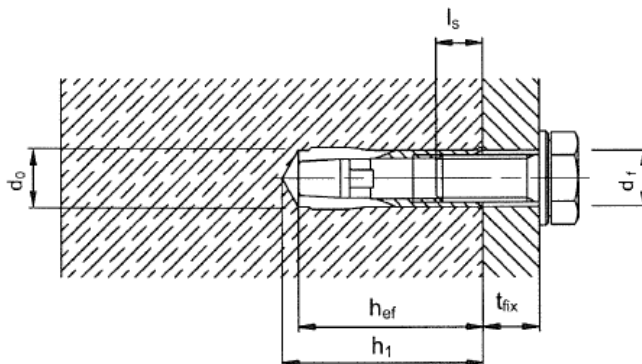

Installation equipment

Anchor size		M6x25	M8x25	M10x25	M12x25	M6x30	M8x30	M8x40	M10x30	M10x40	M12x50	M16x65
Rotary hammer for setting		TE 2 – TE 16									TE16–TE50	
Machine setting tool	HSD-M	6x25/30	8x25/30	8x40	10x25/30	10x40	12x25	12x50	16x65			
Hand setting tool	HSD-G											
Other tools		Hammer, torque wrench, blow out pump										

Setting parameters

Anchor size		M6x25	M6x30	M8x25 ^{a)}	M8x30	M8x40	M10x25 ^{a)}	M10x30 ^{a)}	M10x40	M12x25 ^{a)}	M12x50	M16x65
Minimum spacing and minimum edge distance for HKD / HKD-woL												
Minimum thickness of concrete member	h_{min} [mm]	100	-	100	100	100	100	100	100	100	100	120
Minimum spacing	s_{min} [mm]	80	-	80	60	80	80	60	80	80	125	130
	$c \geq$ [mm]	140	-	140	105	140	140	105	140	140	175	230
Minimum edge distance	c_{min} [mm]	100	-	100	80	140	100	80	140	100	175	230
	$s \geq$ [mm]	150	-	150	120	80	150	120	80	150	125	130
Minimum thickness of concrete member for HKD / HKD-woL												
Minimum thickness of concrete member	h_{min} [mm]	80	-	80	80	80	80	80	80	80	-	-
Minimum spacing	s_{min} [mm]	200	-	200	200	200	200	200	200	200	-	-
Minimum edge distance	c_{min} [mm]	150	-	150	150	150	150	150	150	150	-	-
Minimum spacing and minimum edge distance for HKD-S(R) / HKD-S(R)												
Minimum thickness of concrete member	h_{min} [mm]	-	100	-	100	100	-	100	100	-	100	-
Minimum spacing	s_{min} [mm]	-	60	-	60	80	-	60	80	-	125	-
Minimum edge distance	c_{min} [mm]	-	105	-	105	140	-	105	140	-	175	-
Minimum thickness of concrete member for HKD-S(R) / HKD-S(R)												
Minimum thickness of concrete member	h_{min} [mm]	-	80	-	80	80	-	80	80	-	-	-
Diameter of clearance hole in the fixture	s_{min} [mm]	-	200	-	200	200	-	200	200	-	-	-
Torque moment	c_{min} [mm]	-	150	-	150	150	-	150	150	-	-	-

For spacing (edge distance) smaller than critical spacing (critical edge distance) the design loads have to be reduced.

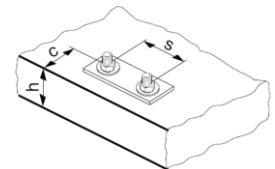

Setting instruction

*For detailed information on installation see instruction for use given with the package of the product.

Setting instruction	
<p>1. Drilling</p>	<p>2. Cleaning</p>
<p>3. Inserting the anchor</p>	<p>4. Setting tools</p> <p>HSD-G M8x30 </p> <p>HSD-M M8x30 </p>
<p>5. Inserting the tools</p>	<p>6. Inserting the tools</p>
<p>7. Attaching the belonging washer</p>	<p>8.</p>

Setting instruction with the stop drill bit TE-CX-HKD only

1. Positioning pre-stressed steel



2. Marking pre-stressed steel position



3. Marking pre-stressed steel position

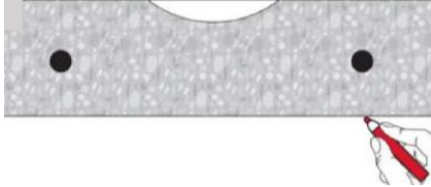

4. Drilling

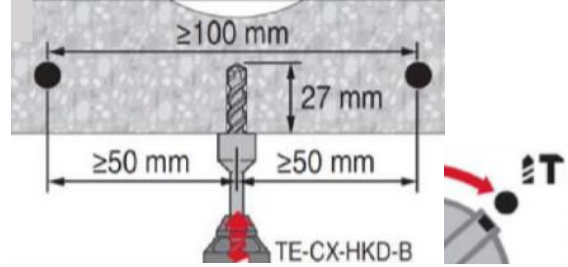

5. Cleaning

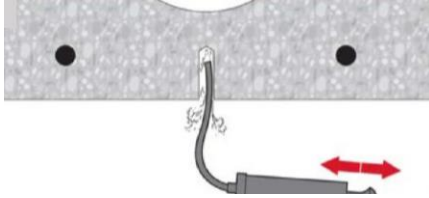

6. Inserting the anchor

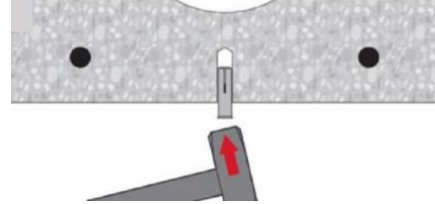

7. Setting tools

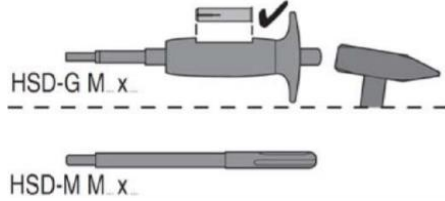

8. Inserting the tools

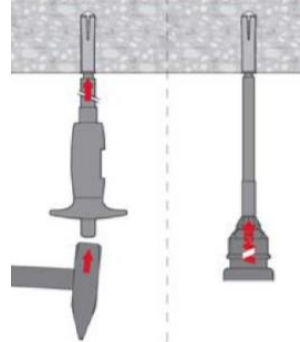

9. Inserting the tools

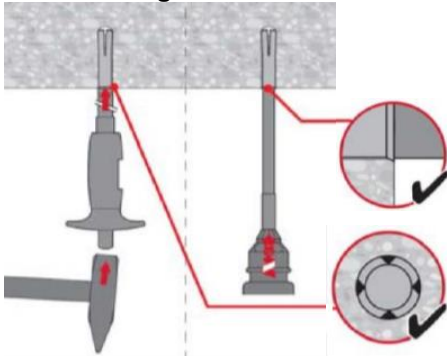

10. Attaching the belonging washer

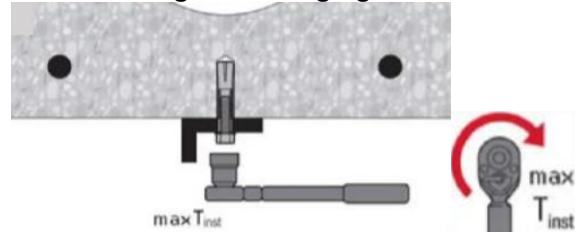

11.

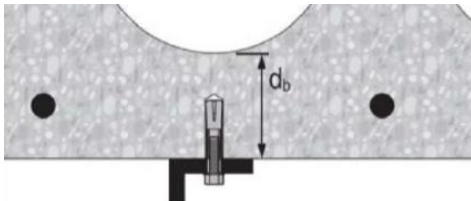



Chemical anchors

Flush

Mechanical anchors

Plastic/Light duty metal anchors

Insulation anchors

HKV Flush anchors

Economical manual set flush anchor

Anchor version



HKV
(M6-M16)

Benefits

- Simple and well proven
- Approved, tested and confirmed by every day jobsite experience
- Reliable setting thanks to simple visual check
- Versatile
- For medium-duty fastening with bolts or threaded rods
- Available in various materials and sizes for maximized coverage of possible applications

Base material



Concrete
(non-cracked)

Basic loading data (for a single anchor)

All data in this section applies to:

- Correct setting (See setting instruction)
- No edge distance and spacing influence
- Concrete as specified in the table
- Minimum base material thickness
- Concrete C 20/25, $f_{ck,cube} = 25 \text{ N/mm}^2$
- Screw or rod with steel grade 5.8 (carbon steel) and / or A4-70 (stainless steel)

Effective anchorage depth

Anchor size	Metric	M6	M8	M10	M10	M12	M16
	Imperial	1/4	5/16	3/8	3/8	1/2	-
Eff. anchorage depth range	h_{ef} [mm]	25	30	30	40	50	65

Mean ultimate resistance

Anchor size	Metric	M6	M8	M10	M10	M12	M16
	Imperial	1/4	5/16	3/8	3/8	1/2	-
Tension $N_{Ru,m}$	HKV [kN]	5,6	7,8	7,8	12,1	16,9	35,3
Shear $V_{Ru,m}$	HKV [kN]	5,5	9,4	11,0	11,0	20,1	37,1

Characteristic resistance

Anchor size	Metric	M6	M8	M10	M10	M12	M16
	Imperial	1/4	5/16	3/8	3/8	1/2	-
Tension N_{Rk}	HKV [kN]	4,2	5,9	5,9	9,1	12,7	26,5
Shear V_{Rk}	HKV [kN]	5,0	8,6	10,0	11,0	18,3	33,8

Design resistance

Anchor size	Metric		M6	M8	M10	M10	M12	M16
	Imperial		1/4	5/16	3/8	3/8	1/2	-
Tension N_{Rd}	HKV	[kN]	2,8	3,9	3,9	6,1	8,5	17,6
Shear V_{Rd}	HKV	[kN]	5,0	8,6	8,0	8,0	14,6	27,0

Recommended loads ^{a)}

Anchor size	Metric		M6	M8	M10	M10	M12	M16
	Imperial		1/4	5/16	3/8	3/8	1/2	-
Tension N_{Rec}	HKV	[kN]	2,0	2,8	2,8	4,3	6,0	12,6
Shear V_{Rec}	HKV	[kN]	2,9	4,9	5,7	5,7	10,5	19,3

a) With overall partial safety factor for action $\gamma = 1,4$. The partial safety factors for action depend on the type of loading and shall be taken from national regulations. According to ETAG 001, the partial safety factor is $\gamma_G = 1,35$ for permanent actions and $\gamma_Q = 1,5$ for variable actions.

Materials

Mechanical properties

Anchor size	Metric		M6	M8	M10	M10	M12	M16
	Imperial		1/4	5/16	3/8	3/8	1/2	-
Nominal tensile strength	f_{uk}	[N/mm ²]	570	570	570	570	570	640
Yield strength	f_{yk}	[N/mm ²]	460	460	460	460	460	510
Stressed cross-section	A_s	[mm ²]	20,7	26,7	32,7	32,7	60,1	105
			17,3	27,46	39,9	39,9	70,6	-
Moment of resistance	W	[mm ³]	32,3	54,6	82,9	82,9	184	431
			28,2	55,8	97,4	97,4	229,8	-
Char. bending resistance for rod or bolt with 5.8 steel grade	$M^{0}_{Rk,s}$	[Nm]	7,6	18,7	37,4	37,4	65,5	167
			10,4	16,5	23,9	24,5	42,4	-

Material quality

Part	Material
Anchor body	Steel Fe/Zn5 galvanized to min. 5 μ m
Expansion plug	Steel material

Anchor dimension

Anchor size	Metric		M6	M8	M10	M10	M12	M16
	Imperial		1/4	5/16	3/8	3/8	1/2	-
Effective anchorage depth	h_{ef}	[mm]	25	30	30	40	50	65
Anchor diameter	d_1	[mm]	7,9	9,95	11,8	11,95	14,9	19,75
				9,9	11,9		15,85	-
Diameter of cone bolt	d_2	[mm]	5,1	6,5	8,2	8,2	10,3	13,8
				6,35		7,86	10,2	-
Length of expansion sleeve	l_1	[mm]	10	12	12	16	20	29
						16,2		-

Anchor body

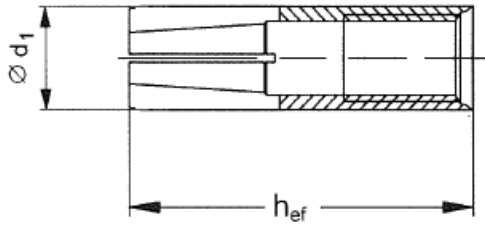

Expansion plugs

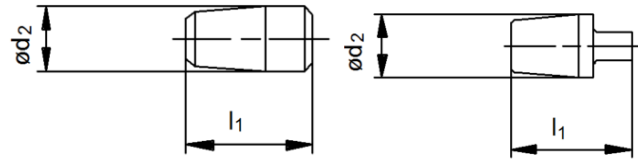

Setting information

Setting details

Anchor size	Metric		M6	M8	M10	M10	M12	M16
	Imperial		1/4	5/16	3/8	3/8	1/2	-
Effective anchorage depth	h_{ef}	[mm]	25	30	30	40	50	65
Nominal diameter of drill bit	d_0	[mm]	8	10	12	12	15 16	20
Cutting diameter of drill bit	$d_{cut} \leq$	[mm]	8,45	10,5	13 12,5	12,5	15,5 16,5	20,5
Depth of drill hole	$h_1 \geq$	[mm]	27	33	33	43	54	70
Diameter of clearance hole in the fixture	$d_f \leq$	[mm]	7	9	12	12	14	18
Torque moment	T_{inst}	[Nm]	4	8	15	15	35	60
Screwing depth	$l_{s,min}$	[mm]	6	8	10	10	12	16
	$l_{s,max}$	mm]	10	12	10,5	15,5	20,0	25,5

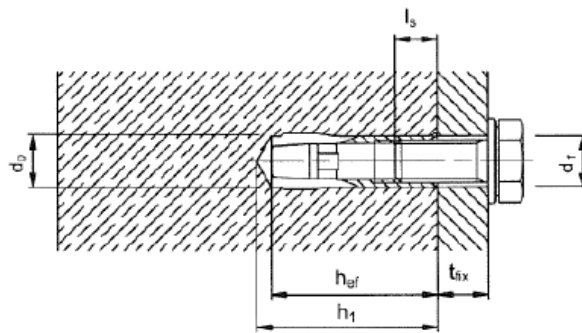

Setting parameters

Anchor size	Metric		M6	M8	M10	M10	M12	M16
	Imperial		1/4	5/16	3/8	3/8	1/2	-
Minimum base material thickness	$h_{min} \geq$	[mm]	100	100	100	100	100	130
Minimum spacing	$s_{min} \geq$	[mm]	200	200	200	200	200	260
Minimum edge distance	$c_{min} \geq$	[mm]	150	150	150	150	150	195

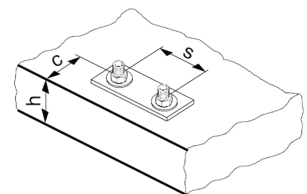

Installation equipment

Anchor size	Metric	M6	M8	M10	M10	M12	M16
	Imperial	1/4	5/16	3/8	3/8	1/2	-
Rotary hammer for setting	TE 1 – TE 30					TE 16 – TE 50	
	TE 1 – TE 30						
Machine setting tool	HSD-M	6x25/30	8x25/30	10x25/30	10x40	12x50	16x65
		1/4x25	5/16x30	3/8x30	3/8x40	1/2x50	-
Hand setting tool	HSD-G	6x25/30	8x25/30	10x25/30	10x40	12x50	16x65
		1/4x25	5/16x30	3/8x30	3/8x40	1/2x50	-
Other tools	hammer, torque wrench, blow out pump						

Setting instruction

*For detailed information on installation see instruction for use given with the package of the product.

Setting instruction

1. Drilling

2. Cleaning

3. Inserting the anchor

4. Setting tools

5. Inserting the tools

6. Inserting the tools

7. Attaching the belonging washer

8.

HRD Plastic frame anchors

Everyday standard plastic frame anchor for redundant fastening applications

Chemical anchors

Mechanical anchors

Plastic/Light duty metal anchors

Insulation anchors

Anchor version



HRD-C
HRD-CR
(M8)



HRD-C
HRD-CR
HRD-CR2
(M10)



HRD-H
HRD-HR
HRD-HR2
HR-HF
(M10)



HRD-K
HRD-KR
HRD-KR2
(M10)



HRD-P
HRD-PR
HRD-PR2
(M10)

Benefits

- Innovative screw design for better hold
- Suitable on practically all base materials
- Flexible embedment depth (approved at 50mm and 70mm)
- Suitable for fastening thicknesses up to 260mm
- Available in 4 different materials for optimum suitability in all corrosive environments
- Pre-assembled for optimum handling and fastening quality

Base material



Concrete (non-cracked)

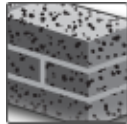

Solid brick

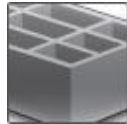

Hollow brick

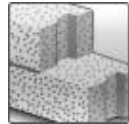

Autoclaved aerated concrete



Drywall



Prestressed hollow core slabs



Window frame

Load conditions



Tensile zone^{a)}



Fire resistance

Other information



European Technical Approval



CE conformity

a) Redundant fastening only

Approvals / certificates

Description	Authority / Laboratory	No./ date of issue
European technical approval ^{a)}	DIBt, Berlin	ETA-07/0219 / 2018-06-28
Fire test report	MFPA, Leipzig	GS 3.2/10-157-1/ 2010-09-02
Window frame report ^{b)}	Ift, Rosenheim	Ift report 105 33035 / 2007-07-09

a) All data given in this section according ETA-07/0219, issue 2017-09-19. The anchor is to be used only for redundant fastening for non-structural applications.

b) Only available for HRD 8

Basic loading data

All data in this section applies to:

- Correct setting (See setting instruction)
- No edge distance and spacing influence
- Base material as specified in the table
- Minimum base material thickness
- Steel failure
- Shear without lever arm
- Anchor in redundant fastening

The additional Hilti recommended data, not part of the approval

Characteristic resistance

Anchor size			HRD 8	HRD 10		
		h_{nom} [mm]	50	50	70	90
Concrete C12/15		N_{Rk} [kN]	2,0	3,0	6,0	-
		N_{Rk} [kN]	6,9 / 6,6 ^{b)}	10,6 / 10,1 ^{b)} / 11,1 ^{c)}		-
Concrete C16/20 – C 50/60		F_{Rk} [kN]	3,0	4,5	8,5	-
		V_{Rk} [kN]	6,9 / 6,6 ^{b)}	10,6 / 10,1 ^{b)} / 11,1 ^{c)}		-
Solid clay brick Mz 2,0 DIN V 105-100/EN 771-1	$f_b \geq 20$ N/mm ²	F_{Rk} [kN]	1,5	3,0 4,5 ^{d)}	f)	-
	$f_b \geq 10$ N/mm ²	F_{Rk} [kN]		2,0 3,0 ^{d)}		
Solid sand-lime brick KS 2,0 DIN V 106 /EN 771-2	$f_b \geq 20$ N/mm ²	F_{Rk} [kN]	2,5	3,0 4,5 ^{d)}	f)	-
	$f_b \geq 10$ N/mm ²	F_{Rk} [kN]		2,0 3,0 ^{d)}		
Lightweight solid block Vbl 0,9 DIN V 18151-100/EN 771	$f_b \geq 20$ N/mm ²	F_{Rk} [kN]	-	3,5 6,0 ^{d)}	f)	-
	$f_b \geq 10$ N/mm ²	F_{Rk} [kN]		2,5 4,5 ^{d)}		
	$f_b \geq 6$ N/mm ²	F_{Rk} [kN]		0,5		
Ital. solid brick Tufo	$f_b \geq n/a$	F_{Rk} [kN]	1,4	-	-	-
Hollow clay brick Hz B 12/1,2 Brick A^{e)}	$f_b \geq 12$ N/mm ²	F_{Rk} [kN]	0,5	-	-	-
Vertic. perforated clay brick Hz 1,2-2DF Brick F^{e)}	$f_b \geq 8$ N/mm ²	F_{Rk} [kN]	-	1,5	-	-
	$f_b \geq 10$ N/mm ²	F_{Rk} [kN]	-	2,0	-	-
	$f_b \geq 12$ N/mm ²	F_{Rk} [kN]	-	2,0	-	-
Vertic. perforated clay brick Hz 1,0-2DF Brick G^{e)}	$f_b \geq 8$ N/mm ²	F_{Rk} [kN]	-	0,4	0,75	-
	$f_b \geq 10$ N/mm ²	F_{Rk} [kN]	-	0,5	0,9	-
	$f_b \geq 12$ N/mm ²	F_{Rk} [kN]	-	0,6	0,9	-
	$f_b \geq 20$ N/mm ²	F_{Rk} [kN]	-	0,9	1,5	-
Vertic. perforated clay brick Hz 1,0-2DF Brick H^{e)}	$f_b \geq 28$ N/mm ²	F_{Rk} [kN]	-	2,0	2,5	-
	$f_b \geq 50$ N/mm ²	F_{Rk} [kN]	-	3,0	3,5	-
Vertic. perforated clay brick Poroton T8 Brick M^{e)}	$f_b \geq 6$ N/mm ²	F_{Rk} [kN]	-	0,75	1,5	-
Vertic. perforated clay brick Hz 1,0-9DF Brick L^{e)}	$f_b \geq 8$ N/mm ²	F_{Rk} [kN]	-	1,2	1,5	-
	$f_b \geq 10$ N/mm ²	F_{Rk} [kN]	-	1,5	1,5	-
	$f_b \geq 12$ N/mm ²	F_{Rk} [kN]	-	1,5	2,0	-
	$f_b \geq 16$ N/mm ²	F_{Rk} [kN]	-	2,0	3,0	-

b) Values for hot-dipped galvanized carbon steel.

c) Values for stainless steel.

d) Valid for edge distance $c \geq 150$ mm, intermediate values can be interpolated.

e) Specification on hollow base material brick types see separate table below.

f) Data can be determined by job-site testing, data for $h_{nom}=50$ mm can be applied.

Characteristic resistance

Anchor size			HRD 8		HRD 10	
			50	50	70	90
		h_{nom} [mm]				
Hollow sand-lime brick KSL 12/1,4 Brick O ^{e)}	$f_b \geq 12 \text{ N/mm}^2$	F_{Rk} [kN]	0,75	-	-	-
Vertic. perforated clay brick Hz 1,6-2DF Brick P ^{e)}	$f_b \geq 8 \text{ N/mm}^2$	F_{Rk} [kN]	-	1,5	-	-
	$f_b \geq 10 \text{ N/mm}^2$	F_{Rk} [kN]	-	1,5	-	-
	$f_b \geq 12 \text{ N/mm}^2$	F_{Rk} [kN]	-	2,0	-	-
Vertic. perforated clay brick Hz 1,6-2DF Brick Q ^{e)}	$f_b \geq 8 \text{ N/mm}^2$	F_{Rk} [kN]	-	-	2,0	-
	$f_b \geq 10 \text{ N/mm}^2$	F_{Rk} [kN]	-	-	2,5	-
	$f_b \geq 12 \text{ N/mm}^2$	F_{Rk} [kN]	-	-	3,0	-
Vertic. perforated clay brick KSL R 1,6-16DF Brick R ^{e)}	$f_b \geq 8 \text{ N/mm}^2$	F_{Rk} [kN]	-	0,9	1,2	-
	$f_b \geq 10 \text{ N/mm}^2$	F_{Rk} [kN]	-	1,2	1,5	-
	$f_b \geq 12 \text{ N/mm}^2$	F_{Rk} [kN]	-	1,5	2,0	-
	$f_b \geq 16 \text{ N/mm}^2$	F_{Rk} [kN]	-	2,0	2,5	-
Lightweight hollow brick Hbl B 2/0,8 Brick S ^{e)}	$f_b \geq 2 \text{ N/mm}^2$	F_{Rk} [kN]	0,30	-	-	-
Lightweight concrete hollow block Hbl 1,2-12DF Brick T ^{e)}	$f_b \geq 8 \text{ N/mm}^2$	F_{Rk} [kN]	-	0,5	0,75	-
	$f_b \geq 10 \text{ N/mm}^2$	F_{Rk} [kN]	-	1,2	2,0	-
Ital. hollow brick Poroton P700 Brick N ^{e)}	$f_b \geq 20 \text{ N/mm}^2$	F_{Rk} [kN]	1,5	-	-	-
Ital. hollow brick Doppio Uni Brick C+I ^{e)}	$f_b \geq 28 \text{ N/mm}^2$	F_{Rk} [kN]	-	-	0,6	-
	$f_b \geq 50 \text{ N/mm}^2$	F_{Rk} [kN]	0,9 (C)	-	1,5 (I)	-
Span. hollow brick Rojo hidrofugano Brick D ^{e)}	$f_b \geq 6 \text{ N/mm}^2$	F_{Rk} [kN]	0,60	-	-	-
Span. hollow brick Ladrillo perforado Brick J ^{e)}	$f_b \geq 16 \text{ N/mm}^2$	F_{Rk} [kN]	-	1,5	2,0	-
Span. hollow brick Clinker mediterraneo Brick K ^{e)}	$f_b \geq 75 \text{ N/mm}^2$	F_{Rk} [kN]	-	-	1,5	-
French hollow brick Brique Creuse B ^{e)}	$f_b \geq 6 \text{ N/mm}^2$	F_{Rk} [kN]	0,50	-	-	-
Autoclaved aerated concrete AAC	AAC 2	F_{Rk} [kN]	-	-	0,9	0,9
	AAC 4	F_{Rk} [kN]	-	-	2,0	2,5
	AAC 6	F_{Rk} [kN]	-	-	2,0	2,5
			-	-	3,5 ^{d)}	4,5 ^{d)}

- b) Values for hot-dipped galvanized carbon steel.
c) Values for stainless steel.
d) Valid for edge distance $c \geq 150\text{mm}$, intermediate values can be interpolated.
e) Specification on hollow base material brick types see separate table below.
f) Data can be determined by job-site testing, data for $h_{nom}=50\text{mm}$ can be applied.

Design resistance

Anchor size			HRD 8	HRD 10		
h_{nom} [mm]			50	50	70	90
Concrete C12/15	N_{Rd} [kN]		1,1	1,7	3,3	-
	V_{Rd} [kN]		5,5 / 5,2 ^{b)}	8,5 / 8,1 ^{b)} / 8,5 ^{c)}		-
Concrete C16/20 – C 50/60	N_{Rd} [kN]		1,7	2,5	4,7	-
	V_{Rd} [kN]		5,5 / 5,2 ^{b)}	8,5 / 8,1 ^{b)} / 8,5 ^{c)}		-
Solid clay brick Mz 2,0 DIN V 105-100/EN 771-1	$f_b \geq 20$ N/mm ²	F_{Rd} [kN]	0,6	1,2 1,8 ^{d)}	f)	-
	$f_b \geq 10$ N/mm ²	F_{Rd} [kN]	0,48	0,8 1,2 ^{d)}	f)	-
Solid sand-lime brick KS 2,0 DIN V 106 /EN 771-2	$f_b \geq 20$ N/mm ²	F_{Rd} [kN]	1,0	1,2 1,8 ^{d)}	f)	-
	$f_b \geq 10$ N/mm ²	F_{Rd} [kN]	0,8	0,8 1,2 ^{d)}	f)	-
Lightweight solid block Vbl 0,9 DIN V 18151-100/EN 771	$f_b \geq 20$ N/mm ²	F_{Rd} [kN]	-	1,4 2,4 ^{d)}	f)	-
	$f_b \geq 10$ N/mm ²	F_{Rd} [kN]	-	1,0 1,8 ^{d)}	f)	-
	$f_b \geq 6$ N/mm ²	F_{Rd} [kN]	0,2	-	-	-
Ital. solid brick Tufo	$f_b \geq n/a$	F_{Rd} [kN]	0,56	-	-	-
Hollow clay brick Hlz B 12/1,2 Brick A ^{e)}	$f_b \geq 12$ N/mm ²	F_{Rd} [kN]	0,2	-	-	-
Vertic. perforated clay brick Hlz 1,2-2DF Brick F ^{e)}	$f_b \geq 8$ N/mm ²	F_{Rd} [kN]	-	0,6	-	-
	$f_b \geq 10$ N/mm ²	F_{Rd} [kN]	-	0,8	-	-
	$f_b \geq 12$ N/mm ²	F_{Rd} [kN]	-	0,8	-	-
Vertic. perforated clay brick Hlz 1,0-2DF Brick G ^{e)}	$f_b \geq 8$ N/mm ²	F_{Rd} [kN]	-	0,16	0,3	-
	$f_b \geq 10$ N/mm ²	F_{Rd} [kN]	-	0,2	0,36	-
	$f_b \geq 12$ N/mm ²	F_{Rd} [kN]	-	0,24	0,36	-
	$f_b \geq 20$ N/mm ²	F_{Rd} [kN]	-	0,36	0,6	-
Vertic. perforated clay brick Hlz 1,0-2DF Brick H ^{e)}	$f_b \geq 28$ N/mm ²	F_{Rd} [kN]	-	0,8	1,0	-
	$f_b \geq 50$ N/mm ²	F_{Rd} [kN]	-	1,2	1,4	-
Vertic. perforated clay brick Poroton T8 Brick M ^{e)}	$f_b \geq 6$ N/mm ²	F_{Rd} [kN]	-	0,3	0,6	-
Vertic. perforated clay brick Hlz 1,0-9DF Brick L ^{e)}	$f_b \geq 8$ N/mm ²	F_{Rd} [kN]	-	0,48	0,6	-
	$f_b \geq 10$ N/mm ²	F_{Rd} [kN]	-	0,6	0,6	-
	$f_b \geq 12$ N/mm ²	F_{Rd} [kN]	-	0,6	0,8	-
	$f_b \geq 16$ N/mm ²	F_{Rd} [kN]	-	0,8	1,2	-

b) Values for hot-dipped galvanized carbon steel.

c) Values for stainless steel.

d) Valid for edge distance $c \geq 150$ mm, intermediate values can be interpolated.

e) Specification on hollow base material brick types see separate table below.

f) Data can be determined by job-site testing, data for $h_{nom}=50$ mm can be applied.

Design resistance

Anchor size			HRD 8		HRD 10	
			50	50	70	90
			h_{nom} [mm]			
Hollow sand-lime brick KSL 12/1,4 Brick O^{e)}	$f_b \geq 12 \text{ N/mm}^2$	F_{Rd} [kN]	0,3	-	-	-
	$f_b \geq 8 \text{ N/mm}^2$	F_{Rd} [kN]	-	0,6	-	-
	$f_b \geq 10 \text{ N/mm}^2$	F_{Rd} [kN]	-	0,6	-	-
Vertic. perforated clay brick Hz 1,6-2DF Brick P^{e)}	$f_b \geq 12 \text{ N/mm}^2$	F_{Rd} [kN]	-	0,8	-	-
	$f_b \geq 8 \text{ N/mm}^2$	F_{Rd} [kN]	-	-	0,8	-
	$f_b \geq 10 \text{ N/mm}^2$	F_{Rd} [kN]	-	-	1,0	-
Vertic. perforated clay brick Hz 1,6-2DF Brick Q^{e)}	$f_b \geq 12 \text{ N/mm}^2$	F_{Rd} [kN]	-	-	1,2	-
	$f_b \geq 8 \text{ N/mm}^2$	F_{Rd} [kN]	-	0,36	0,48	-
	$f_b \geq 10 \text{ N/mm}^2$	F_{Rd} [kN]	-	0,48	0,6	-
Vertic. perforated clay brick KSL R 1,6-16DF Brick R^{e)}	$f_b \geq 12 \text{ N/mm}^2$	F_{Rd} [kN]	-	0,6	0,8	-
	$f_b \geq 16 \text{ N/mm}^2$	F_{Rd} [kN]	-	0,8	1,0	-
	$f_b \geq 2 \text{ N/mm}^2$	F_{Rd} [kN]	0,12	-	-	-
Lightweight hollow brick Hbl B 2/0,8 Brick S^{e)}	$f_b \geq 8 \text{ N/mm}^2$	F_{Rd} [kN]	-	0,2	0,3	-
	$f_b \geq 10 \text{ N/mm}^2$	F_{Rd} [kN]	-	0,48	0,8	-
Ital. hollow brick Poroton P700 Brick N^{e)}	$f_b \geq 20 \text{ N/mm}^2$	F_{Rd} [kN]	0,6	-	-	-
Ital. hollow brick Doppio Uni Brick C+I^{e)}	$f_b \geq 28 \text{ N/mm}^2$	F_{Rd} [kN]	-	-	0,24	-
	$f_b \geq 50 \text{ N/mm}^2$	F_{Rd} [kN]	0,36 (C)	-	0,6 (I)	-
Span. hollow brick Rojo hidrofugano Brick D^{e)}	$f_b \geq 6 \text{ N/mm}^2$	F_{Rd} [kN]	0,24	-	-	-
Span. hollow brick Ladrillo perforado Brick J^{e)}	$f_b \geq 16 \text{ N/mm}^2$	F_{Rd} [kN]	-	0,6	0,8	-
Span. hollow brick Clinker mediterraneo Brick K^{e)}	$f_b \geq 75 \text{ N/mm}^2$	F_{Rd} [kN]	-	-	0,6	-
French hollow brick Brique Creuse B^{e)}	$f_b \geq 6 \text{ N/mm}^2$	F_{Rd} [kN]	0,20	-	-	-
Autoclaved aerated concrete AAC	AAC 2	F_{Rd} [kN]	-	-	0,45	0,45
	AAC 4	F_{Rd} [kN]	0,21	-	1,0	1,25
	AAC 6	F_{Rd} [kN]	0,21	-	1,0	1,25
			0,21	-	1,75 ^{d)}	2,25 ^{d)}

b) Values for hot-dipped galvanized carbon steel.

c) Values for stainless steel.

d) Valid for edge distance $c \geq 150\text{mm}$, intermediate values can be interpolated.

e) Specification on hollow base material brick types see separate table below.

f) Data can be determined by job-site testing, data for $h_{nom}=50\text{mm}$ can be applied.

Recommended loads a)

Anchor size			HRD 8	HRD 10			
h_{nom} [mm]			50	50	70	90	
Concrete C12/15	N_{Rec} [kN]		0,8	1,2	2,4	-	
	V_{Rec} [kN]		3,9 / 3,7 ^{b)}	6,1 / 5,8 ^{b)} / 6,1 ^{c)}		-	
Concrete C16/20 – C 50/60	N_{Rec} [kN]		1,2	1,8	3,4	-	
	V_{Rec} [kN]		3,9 / 3,7 ^{b)}	6,1 / 5,8 ^{b)} / 6,1 ^{c)}		-	
Solid clay brick Mz 2,0 DIN V 105-100/EN 771-1	$f_b \geq 20$ N/mm ²	F_{Rec} [kN]	0,42	0,85 1,28 ^{d)}	f)	-	
	$f_b \geq 10$ N/mm ²	F_{Rec} [kN]		0,34			0,57 0,85 ^{d)}
Solid sand-lime brick KS 2,0 DIN V 106 /EN 771-2	$f_b \geq 20$ N/mm ²	F_{Rec} [kN]	0,7	0,85 1,28 ^{d)}	f)	-	
	$f_b \geq 10$ N/mm ²	F_{Rec} [kN]		0,57			0,57 0,85 ^{d)}
Lightweight solid block Vbl 0,9 DIN V 18151-100/EN 771	$f_b \geq 20$ N/mm ²	F_{Rec} [kN]	-	1,0 1,71 ^{d)}	f)	-	
	$f_b \geq 10$ N/mm ²	F_{Rec} [kN]		-			0,71 1,28 ^{d)}
	$f_b \geq 6$ N/mm ²	F_{Rec} [kN]		0,14			-
Ital. solid brick Tufo	$f_b \geq n/a$	F_{Rd} [kN]	0,4	-	-	-	
Hollow clay brick Hz B 12/1,2 Brick A ^{e)}	$f_b \geq 12$ N/mm ²	F_{Rd} [kN]	0,14	-	-	-	
Vertic. perforated clay brick Hz 1,2-2DF Brick F ^{e)}	$f_b \geq 8$ N/mm ²	F_{Rd} [kN]	-	0,42	-	-	
	$f_b \geq 10$ N/mm ²	F_{Rd} [kN]	-	0,57	-	-	
	$f_b \geq 12$ N/mm ²	F_{Rd} [kN]	-	0,57	-	-	
Vertic. perforated clay brick Hz 1,0-2DF Brick G ^{e)}	$f_b \geq 8$ N/mm ²	F_{Rd} [kN]	-	0,11	0,21	-	
	$f_b \geq 10$ N/mm ²	F_{Rd} [kN]	-	0,14	0,25	-	
	$f_b \geq 12$ N/mm ²	F_{Rd} [kN]	-	0,17	0,25	-	
	$f_b \geq 20$ N/mm ²	F_{Rd} [kN]	-	0,25	0,42	-	
Vertic. perforated clay brick Hz 1,0-2DF Brick H ^{e)}	$f_b \geq 28$ N/mm ²	F_{Rd} [kN]	-	0,57	0,71	-	
	$f_b \geq 50$ N/mm ²	F_{Rd} [kN]	-	0,85	1,0	-	
Vertic. perforated clay brick Poroton T8 Brick M ^{e)}	$f_b \geq 6$ N/mm ²	F_{Rd} [kN]	-	0,21	0,42	-	
Vertic. perforated clay brick Hz 1,0-9DF Brick L ^{e)}	$f_b \geq 8$ N/mm ²	F_{Rd} [kN]	-	0,34	0,42	-	
	$f_b \geq 10$ N/mm ²	F_{Rd} [kN]	-	0,42	0,42	-	
	$f_b \geq 12$ N/mm ²	F_{Rd} [kN]	-	0,42	0,57	-	
	$f_b \geq 16$ N/mm ²	F_{Rd} [kN]	-	0,57	0,85	-	

- a) With overall partial safety factor for action $\gamma = 1,4$. The partial safety factors for action depend on the type of loading and shall b-e taken from national regulations.
- b) Values for hot-dipped galvanized carbon steel.
- c) Values for stainless steel.
- d) Valid for edge distance $c \geq 150$ mm, intermediate values can be interpolated.
- e) Specification on hollow base material brick types see separate table below.
- f) Data can be determined by job-site testing, data for $h_{nom}=50$ mm can be applied.

Recommended loads ^{a)}

Anchor size			HRD 8	HRD 10		
			50	50	70	90
h_{nom} [mm]						
Hollow sand-lime brick KSL 12/1,4 Brick O^{e)}	$f_b \geq 12 \text{ N/mm}^2$	F_{Rec} [kN]	0,21	-	-	-
Vertic. perforated clay brick Hlz 1,6-2DF Brick P^{e)}	$f_b \geq 8 \text{ N/mm}^2$	F_{Rec} [kN]	-	0,42	-	-
	$f_b \geq 10 \text{ N/mm}^2$	F_{Rec} [kN]	-	0,42	-	-
	$f_b \geq 12 \text{ N/mm}^2$	F_{Rec} [kN]	-	0,57	-	-
Vertic. perforated clay brick Hlz 1,6-2DF Brick Q^{e)}	$f_b \geq 8 \text{ N/mm}^2$	F_{Rec} [kN]	-	-	0,57	-
	$f_b \geq 10 \text{ N/mm}^2$	F_{Rec} [kN]	-	-	0,71	-
	$f_b \geq 12 \text{ N/mm}^2$	F_{Rec} [kN]	-	-	0,85	-
Vertic. perforated clay brick KSL R 1,6-16DF Brick R^{e)}	$f_b \geq 8 \text{ N/mm}^2$	F_{Rec} [kN]	-	0,25	0,34	-
	$f_b \geq 10 \text{ N/mm}^2$	F_{Rec} [kN]	-	0,34	0,42	-
	$f_b \geq 12 \text{ N/mm}^2$	F_{Rec} [kN]	-	0,42	0,57	-
	$f_b \geq 16 \text{ N/mm}^2$	F_{Rec} [kN]	-	0,57	0,71	-
Lightweight hollow brick Hbl B 2/0,8 Brick S^{e)}	$f_b \geq 2 \text{ N/mm}^2$	F_{Rec} [kN]	0,09	-	-	-
Lightweight concrete hollow block Hbl 1,2-12DF Brick T^{e)}	$f_b \geq 8 \text{ N/mm}^2$	F_{Rec} [kN]	-	0,14	0,21	-
	$f_b \geq 10 \text{ N/mm}^2$	F_{Rec} [kN]	-	0,34	0,57	-
Ital. hollow brick Poroton P700 Brick N^{e)}	$f_b \geq 20 \text{ N/mm}^2$	F_{Rec} [kN]	0,43	-	-	-
Ital. hollow brick Doppio Uni Brick C+I^{e)}	$f_b \geq 28 \text{ N/mm}^2$	F_{Rec} [kN]	-	-	0,17	-
	$f_b \geq 50 \text{ N/mm}^2$	F_{Rec} [kN]	0,25 (C)	-	0,42 (I)	-
Span. hollow brick Rojo hidrofugano Brick D^{e)}	$f_b \geq 6 \text{ N/mm}^2$	F_{Rec} [kN]	0,17	-	-	-
Span. hollow brick Ladrillo perforado Brick J^{e)}	$f_b \geq 16 \text{ N/mm}^2$	F_{Rec} [kN]	-	0,42	0,57	-
Span. hollow brick Clinker mediterraneo Brick K^{e)}	$f_b \geq 75 \text{ N/mm}^2$	F_{Rec} [kN]	-	-	0,42	-
French hollow brick Brique Creuse B^{e)}	$f_b \geq 6 \text{ N/mm}^2$	F_{Rec} [kN]	0,14	-	-	-
Autoclaved aerated concrete AAC	AAC 2	F_{Rec} [kN]	-	-	0,32	0,32
	AAC 4	F_{Rec} [kN]	0,15	-	0,71	0,89
			0,15	-	0,71	0,89
	AAC 6	F_{Rec} [kN]	0,15	-	1,25 ^{d)}	1,6 ^{d)}

a) With overall partial safety factor for action $\gamma = 1,4$. The partial safety factors for action depend on the type of loading and shall be taken from national regulations.

b) Values for stainless steel.

c) Valid for edge distance $c \geq 150\text{mm}$, intermediate values can be interpolated.

d) Specification on hollow base material brick types see separate table below.

e) Data can be determined by job-site testing, data for $h_{nom}=50\text{mm}$ can be applied.

Characteristic resistance for pull-out failure (plastic sleeve) for use in concrete

Anchor size		HRD 8	HRD 10	
In standard concrete slabs				
Embedment depth	$h_{nom} \geq$ [mm]	50	50	70
Characteristic resistance	$\geq C16/20$ $N_{Rk,p}$ [kN]	3,0	4,5	8,5
	C12/15 $N_{Rk,p}$ [kN]	2,0	3,0	6,0
Partial safety factor	$\gamma_{Mc}^{a)}$	1,8		
In thin skins (whether resistant skins of external wall panels)				
Embedment depth	$h_{nom} \geq$ [mm]	-	50	-
Characteristic resistance	$h=100\text{mm}$ $\geq C16/20$ $N_{Rk,p}$ [kN]	-	3,5	-
	$\text{to } 400\text{mm}$ C12/15 $N_{Rk,p}$ [kN]	-	2,5	-
Partial safety factor	$\gamma_{Mc}^{a)}$	1,8		
In precast prestressed hollow cored slabs				
Embedment depth	$h_{nom} \geq$ [mm]	-	50	
Characteristic resistance	$d_b \geq 25\text{mm}$ $\geq C16/20$ $N_{Rk,p}$ [kN]	-	0,6	
	$d_b \geq 30\text{mm}$ $\geq C16/20$ $N_{Rk,p}$ [kN]	-	1,5	
	$d_b \geq 35\text{mm}$ $\geq C16/20$ $N_{Rk,p}$ [kN]	-	2,5	
	$d_b \geq 40\text{mm}$ $\geq C16/20$ $N_{Rk,p}$ [kN]	-	3,5	
Partial safety factor	$\gamma_{Mc}^{a)}$	1,8		

a) In absence of other regulations.

Specification of hollow base material brick types

Specification	Picture	Drilling method	Specification	Picture	Drilling method
Brick A Hlz B 12/1,2 LxWxH [mm]: 300x240x248 h _{min} [mm]: 240		Rotary drilling	Brick B Brique Creuse LxWxH [mm] : 210x198x... h _{min} [mm]: 210		Rotary drilling
Brick C Doppio Uni LxWxH [mm]: 230x120x100 h _{min} [mm]: 120		Rotary drilling	Brick D Rojo hidrofugano LxWxH [mm]: 240x115x50 h _{min} [mm]: 115		Rotary drilling
brick E Mattone LxWxH [mm]: 240x180x100 h _{min} [mm]: 180		Rotary drilling	brick F Hlz 1,2-2DF LxWxH [mm]: 240x115x113 h _{min} [mm]: 115		Hammer drilling
brick G Hlz 1,0-2DF LxWxH [mm]: 240x115x113 h _{min} [mm]: 110		Hammer drilling	brick H VHlz 1,6-2DF LxWxH [mm]: 240x115x113 h _{min} [mm]: 115		Hammer drilling
brick I Doppio Uni LxWxH [mm]: 250x120x190 h _{min} [mm]: 120		Rotary drilling	brick J Ladrillo perforado LxWxH [mm]: 240x110x100 h _{min} [mm]: 110		Rotary drilling
brick K Clinker mediterr. LxWxH [mm]: 240x113x50 h _{min} [mm]: 113		Hammer drilling	brick L Hlz 1,0-9DF LxWxH [mm]: 372x175x238 h _{min} [mm]: 175		Rotary drilling
brick M Poroton T8 LxWxH [mm]: 248x365x249 h _{min} [mm]: 365		Rotary drilling	brick N Poroton P700 LxWxH [mm]: 225x300x190 h _{min} [mm]: 300		Rotary drilling
Hollow sand-lime bricks according EN 771-2					
brick O KSL 12/1,4 LxWxH [mm]: 240x248x248 h _{min} [mm]: 240		Hammer drilling	brick P KS L 1,6-2DF LxWxH [mm]: 240x115x113 h _{min} [mm]: 115		Hammer drilling
brick Q KS L 1,4-3DF LxWxH [mm]: 240x175x113 h _{min} [mm]: 175		Hammer drilling	brick R KS L R 1,6-16DF LxWxH [mm]: 480x240x248 h _{min} [mm]: 240		Rotary drilling
brick S Hbl 2/0,8 LxWxH [mm]: 497x240x248 h _{min} [mm]: 240		Hammer drilling	brick T Hbl 1,2-12DF LxWxH [mm]: 497x175x238 h _{min} [mm]: 175		Rotary drilling

Requirements for redundant fastening

The definition of redundant fastening according to Member States is given in ETAG 020. In Absence of a definition by a Member State the following default values may be taken

Maximum number of fixing points	Minimum number of anchors per fixing point	Maximum design load of action N_{sd} per fixing point ^{a)}
3	1	3 [kN]
4	1	4,5 [kN]

Materials

Mechanical properties

Anchor size		HRD 8		HRD 10		
		Galvanized steel	Stainless steel	Galvanized steel	Hot-deep galvanized	Stainless steel
Nominal tensile strength f_{uk}	[N/mm ²]	600	580	600	600	630
Yield strength f_{yk}	[N/mm ²]	480	450	480	480	480
Stressed cross-section A_s	[mm ²]	22,9	22,9	35,3	33,7	35,3
Moment of resistance W	[mm ³]	15,5	15,5	29,5	27,6	29,5
Char. bending resistance $M^0_{Rk,s}$	[Nm]	11,1	10,8	21,3	19,9	22,3

Material quality

Part	Material	
Sleeve	Polyamide, colour red	
Screw ^{a)}	HRD-C, -H, -K, -P HDS-C, -H, -K, -P	Carbon steel, galvanized to min.5 μ m
	HRD-HF; HDS-HF	Carbon steel, hot-dip galvanized to min. 65 μ m
	HRD-CR2, -HR2, -KR2, -PR2 HDS-CR2, -HR2, -KR2, -PR2	Stainless steel, corrosion class II: 1.4301 / 1.4567
	HRD-CR, -HR, -KR, -PR HDS-CR, -HR, -KR, -PR	Stainless steel, corrosion class III: 1.4362/1.4401/1.4404/1.4571

a) Marking of the screw (HDR and HDS) depending on the supply.

Anchor dimension

Anchor size		HRD 8	HRD 10
Minimum thickness of fixture	$t_{fix,min}$ [mm]	0	0
Maximum thickness of fixture	$t_{fix,max}$ [mm]	90	260
Diameter of the sleeve	d_{nom} [mm]	8	10
Minimum length of the sleeve	$l_{1,min}$ [mm]	60	60
Maximum length of the sleeve	$l_{1,max}$ [mm]	140	310
Diameter of plastic washer	d_{pw} [mm]	-	17,5
Thickness of plastic washer	t_{pw} [mm]	-	2
Diameter of the screw	d_s [mm]	6	7
Minimum length of the screw	$l_{2,min}$ [mm]	65	65
Maximum length of the screw	$l_{2,max}$ [mm]	145	315
Head diameter of countersunk screw	d_{sc} [mm]	11	14
Head diameter of hexhead screw	d_{sw} [mm]	-	17,5

Anchor sleeve

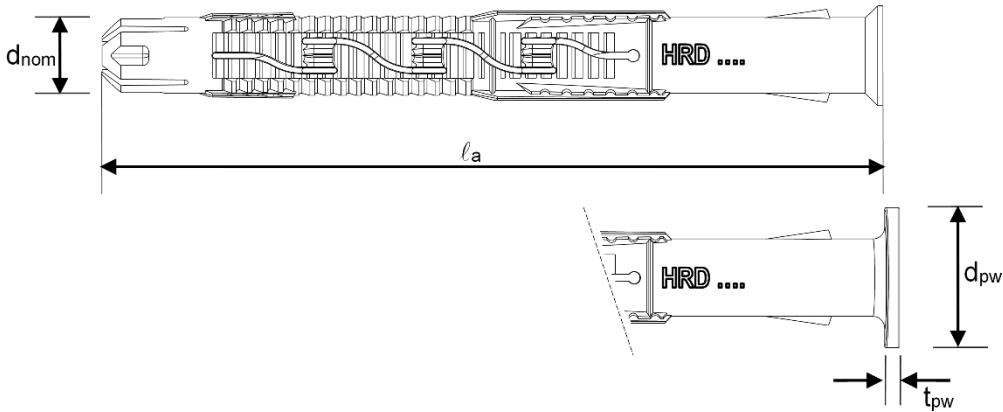

Special screw

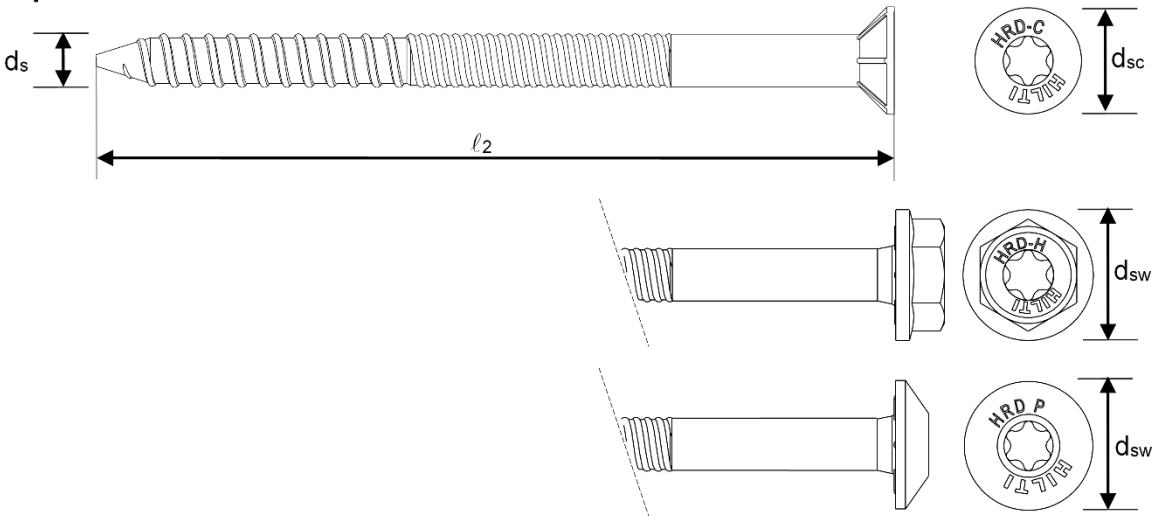

Setting information

Installation temperature

-10°C to +40°C

Service temperature range

Hilti HRD frame anchors may be applied in the temperature range given below.

Temperature range	Base material temperature	Max. long term base material temperature	Max. short term base material temperature
Temperature range	-40 °C to +80 °C	+50 °C	+80 °C

Max short term base material temperature

Short-term elevated base material temperatures are those that occur over brief intervals, e.g. as a result of diurnal cycling.

Max long term base material temperature

Long-term elevated base material temperatures are roughly constant over significant periods of time.

Chemical anchors
Mechanical anchors
Plastic/Light duty metal anchors
Insulation anchors

Setting details

Anchor size			HRD 8	HRD 10
Drill hole diameter	d_o	[mm]	8	10
Cutting diameter of drill bit	$d_{cut} \leq$	[mm]	8,45	10,45
Depth of drilled hole to deepest point	$h_{1,1} \geq$	[mm]	60	60
	$h_{1,2} \geq$	[mm]	-	80
	$h_{1,3} \geq$	[mm]	-	100 ^{a)}
Overall plastic anchor embedment depth in base material	$h_{nom,1} \geq$	[mm]	50	50
	$h_{nom,2} \geq$	[mm]	-	70
	$h_{nom,3} \geq$	[mm]	-	90 ^{a)}
Diameter of clearance hole in the fixture	Countersunk screw	$d_f \leq$	8,5	11
	Hexhead screw	$d_f \leq$	-	12

a) For use in AAC

Setting parameters

Anchor size			HRD 8	HRD 10	
	h_{nom}	[mm]	50	50	70
Minimum base material thickness	Concrete	h_{min}	100	100	120
	Concrete thin skin	h_{min}	-	40	-
	Masonry ^{e)}	h_{min}	115-300		
Minimum spacing	Concrete \geq C16/20	s_{min}	100	50	
		for $c \geq$	50	100 ^{c)}	
	Concrete C12/15	s_{min}	140	70	
		for $c \geq$	70	140 ^{c)}	
	Masonry and AAC	a_{min}	250	250	
		s_{min1}	200 (120 ^{d)})	100	
	s_{min2}	400 (240 ^{d)})	100		
Minimum edge distance	Concrete \geq C16/20	c_{min}	50	50	
		for $s \geq$	100	150 ^{c)}	
	Concrete C12/15	c_{min}	70	70	
	for $s \geq$	140	210 ^{c)}		
Masonry and AAC	c_{min}	100 (60 ^{d)})	100		
Critical spacing in concrete ^{a)}	Concrete \geq C16/20	$s_{cr,N}$	62	80	125
	Concrete C12/15	$s_{cr,N}$	68	90	135
Critical edge distance in concrete ^{b)}	Concrete \geq C16/20	$c_{cr,N}$	100	100	
	Concrete C12/15	$c_{cr,N}$	140	140	

a) For spacing larger than the critical spacing each anchor in a group can be considered in design

b) For edge distance smaller than critical edge distance the design loads

c) Linear interpolation allowed

d) Only for brick "Doppio Uni" and "Mattone"

e) Minimum base material thickness of masonry depends on brick type; see specification of brick types in the table above

For spacing (edge distance) smaller than critical spacing (critical edge distance) the design loads have to be reduced.

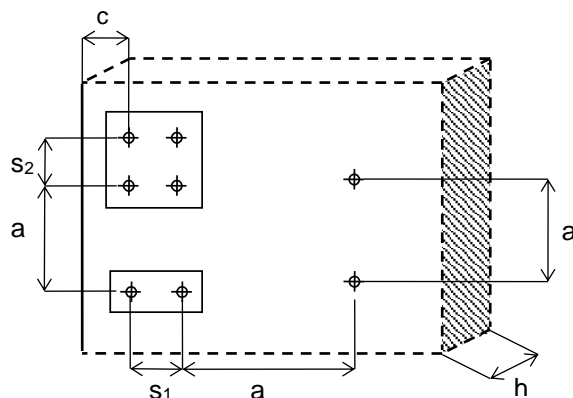

Installation equipment

Anchor size	HRD 8	HRD 10
Rotary hammer	TE 2- TE16	
Other tools	Hammer, Screwdriver	

Admissible anchor positions, min. spacing and edge distance of anchors and distance between anchor groups in precast pre-stressed hollow core slabs

Anchor size		HRD 8	HRD 10
Overall plastic anchor embedment depth in the base material	$h_{nom} \geq$ [mm]	-	50
Bottom flange thickness	$d_b \geq$ [mm]	-	25
Core distance	$l_c \geq$ [mm]	-	100
Prestressing steel distance	$l_p \geq$ [mm]	-	100
Distance between anchor position and prestressing steel	$a_p \geq$ [mm]	-	50
Minimum edge distance	$c_{min} \geq$ [mm]	-	100
Minimum anchor spacing	$s_{min} \geq$ [mm]	-	100
Minimum distance between anchor groups	$a_{min} \geq$ [mm]	-	100

Schemes of distances and spacing

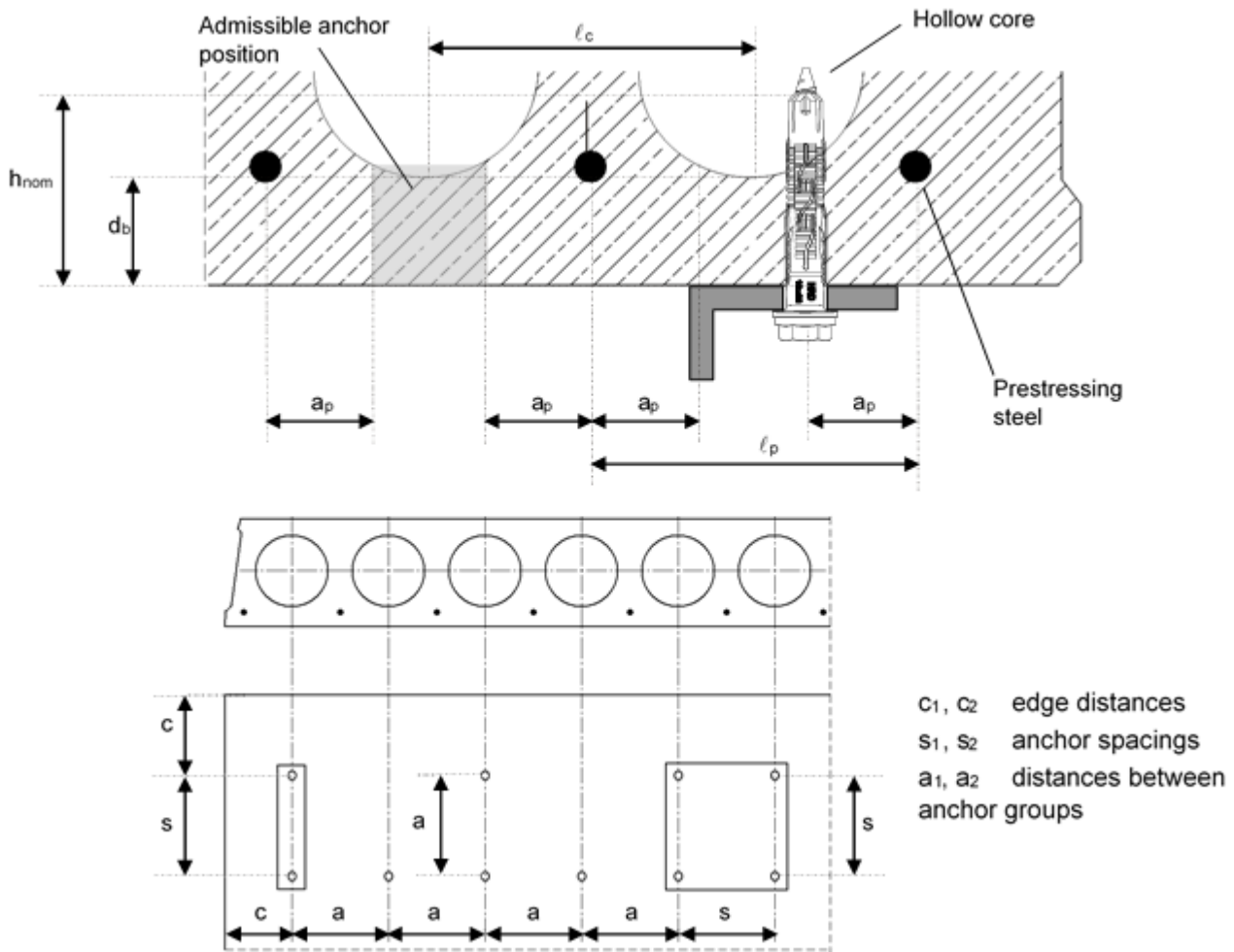

Setting instruction

*For detailed information on installation see instruction for use given with the package of the product.

Setting instruction for HRD	
<p>1. Drilling</p>	<p>2. Inserting the anchor</p>
<p>3. Inserting the anchor</p>	<p>4. Setting tools</p>
<p>5. Checking</p>	<p>6. Attaching the belonging washer</p>
<p>7. Attaching the belonging washer</p>	
Additional preparation in case of application in precast prestressed hollow core slabs	
<p>1. Location of pre-stressed bars</p>	<p>2. Marking location of pre-stressed bars</p>
<p>3. Marking location of pre-stressed bars</p>	<p>4. Drilling</p>

HRD Plastic frame anchors

Everyday standard plastic frame anchor for single use applications

Anchor version



HRD-C
HRD-CR
HRD-CR2
(M10)



HRD-H
HRD-HR
HRD-HR2
HR-HF
(M10)



HRD-K
HRD-KR
HRD-KR2
(M10)



HRD-P
HRD-PR
HRD-PR2
(M10)

Benefits

- Innovative screw design for better hold
- Suitable on practically all base materials
- Flexible embedment depth (approved at 50mm and 70mm)
- Suitable for fastening thicknesses up to 260mm
- Available in 4 different materials for optimum suitability in all corrosive environments
- Pre-assembled for optimum handling and fastening quality

Base material



Concrete

Approvals / certificates

Description	Authority / Laboratory	No./ date of issue
Allgemeine bauaufsichtliche Zulassung ^{a)} (German approval)	DIBt, Berlin	Z-21.2-2034 / 2014-11-14

c) All data given in this section according Z-21.2-2034, issue 2014-11-14.

Basic loading data

All data in this section applies to:

- Correct setting (See setting instruction)
- No edge distance and spacing influence
- Base material as specified in the table
- Minimum base material thickness
- Shear without lever arm
- Use at max. temperature of +30°C(long term) or +50°C (short term)

Mean ultimate resistance

Anchor type		HRD 10		
Anchor screw material		Galvanized steel	Hot-dip galvanized steel	Stainless steel
Non-cracked concrete				
Tension $N_{Ru,m}$	[kN]	18,4	17,5	19,3
Shear $V_{Ru,m}$	[kN]	11,1	10,6	11,7
Cracked concrete				
Tension $N_{Ru,m}$	[kN]	5,8	5,8	5,8
Shear $V_{Ru,m}$	[kN]	11,1	10,6	11,7

Characteristic resistance

Anchor type		HRD 10		
Anchor screw material		Galvanized steel	Hot-dip galvanized steel	Stainless steel
Non-cracked concrete				
Tension N_{Rk}	[kN]	15,2	15,2	15,2
Shear V_{Rk}	[kN]	10,6	10,1	11,1
Cracked concrete				
Tension N_{Rk}	[kN]	4,4	4,4	4,4
Shear V_{Rk}	[kN]	9,0	9,0	9,0

Design resistance

Anchor type		HRD 10		
Anchor screw material		Galvanized steel	Hot-dip galvanized steel	Stainless steel
Non-cracked concrete				
Tension N_{Rd}	[kN]	6,0	6,0	6,0
Shear V_{Rd}	[kN]	8,5	8,1	8,5
Cracked concrete				
Tension N_{Rd}	[kN]	1,7	1,7	1,7
Shear V_{Rd}	[kN]	5,0	5,0	5,0

Recommended loads ^{a)}

Anchor type		HRD 10		
Anchor screw material		Galvanized steel	Hot-dip galvanized steel	Stainless steel
Non-cracked concrete				
Tension N_{Rec}	[kN]	4,3	4,3	4,3
Shear V_{Rec}	[kN]	6,1	5,8	6,1
Cracked concrete				
Tension N_{Rec}	[kN]	1,2	1,2	1,2
Shear V_{Rec}	[kN]	3,6	3,6	3,6

a) With overall partial safety factor for action $\gamma = 1,4$. The partial safety factors for action depend on the type of loading and shall be taken from national regulations.

Materials

Mechanical properties

Anchor type		HRD 10		
Anchor screw material		Galvanized steel	Hot-dip galvanized steel	Stainless steel
Nominal tensile strength f_{uk}	[N/mm ²]	600	600	630
Yield strength f_{yk}	[N/mm ²]	480	480	480
Stressed cross-section A_s	[mm ²]	35,3	33,7	35,3
Moment of resistance W	[mm ³]	29,5	27,6	29,5
Char. bending resistance $M^0_{Rk,s}$	[Nm]	21,3	19,9	22,3

Material quality

Part	Material
Sleeve	Polyamide, colour red
Screw	HRD-C, -H, -K, -P
	HRD-HF
	HRD-CR2, -HR2, -KR2, -PR2
	HRD-CR, -HR, -KR, -PR

Anchor dimension

Anchor size		HRD 10
Minimum thickness of fixture	$t_{fix,min}$ [mm]	0
Maximum thickness of fixture	$t_{fix,max}$ [mm]	260
Diameter of the sleeve	d_{nom} [mm]	10
Minimum length of the sleeve	$l_{1,min}$ [mm]	60
Maximum length of the sleeve	$l_{1,max}$ [mm]	310
Diameter of plastic washer	d_{pw} [mm]	17,5
Thickness of plastic washer	t_{pw} [mm]	2
Diameter of the screw	d_s [mm]	7
Minimum length of the screw	$l_{2,min}$ [mm]	65
Maximum length of the screw	$l_{2,max}$ [mm]	315
Head diameter of countersunk screw	d_{sc} [mm]	14
Head diameter of hexhead screw	d_{sw} [mm]	17,5
Length of threaded section	L_t [mm]	70

Anchor sleeve

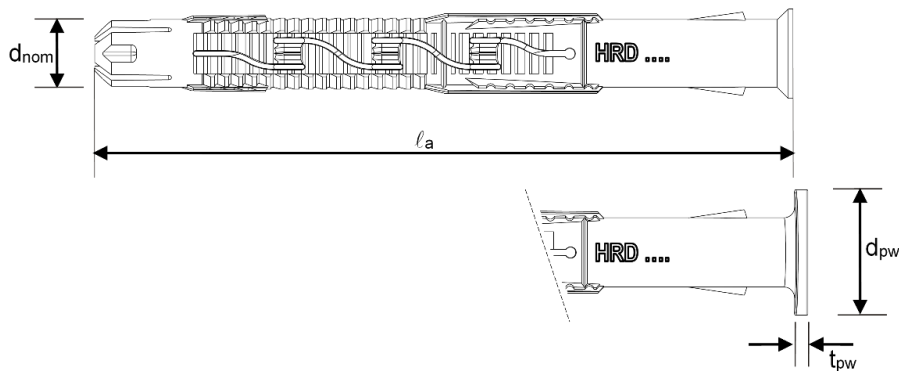

Special screw

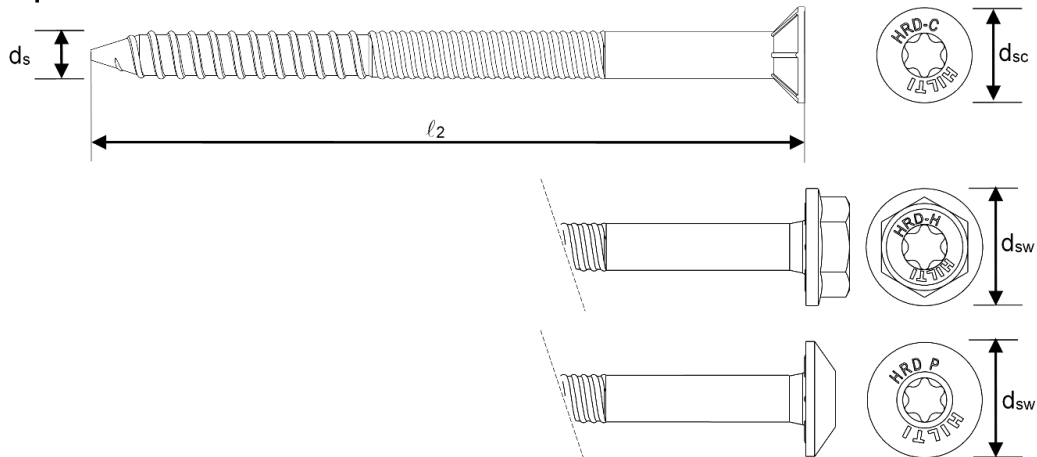

Setting information

Installation temperature

-10°C to +40°C

Service temperature range

Hilti HRD frame anchors may be applied in the temperature range given below.

Temperature range	Base material temperature	Max. long term base material temperature	Max. short term base material temperature
Temperature range I	-40 °C to +50 °C	+30 °C	+50 °C
Temperature range II	-40 °C to +80 °C	+50 °C	+80 °C

Max short term base material temperature

Short-term elevated base material temperatures are those that occur over brief intervals, e.g. as a result of diurnal cycling.

Max long term base material temperature

Long-term elevated base material temperatures are roughly constant over significant periods of time.

Setting details

Anchor size			HRD 10
Drill hole diameter	d_o	[mm]	10
Cutting diameter of drill bit	$d_{cut} \leq$	[mm]	10,45
Depth of drilled hole to deepest point	$h_1 \geq$	[mm]	80
Overall plastic anchor embedment depth in base material	$h_{nom} \geq$	[mm]	70
Diameter of clearance hole in the fixture	Countersunk screw	$d_f \leq$	11
	Hexhead screw	$d_f \leq$	12

Setting parameters

Anchor size			HRD 10	
		h_{nom}	70	
Minimum base material thickness	Concrete	h_{min}	120	
Minimum spacing ^{a)}	Concrete \geq C20/25	s_{min}	50	
		for $c \geq$	100	
Minimum edge distance ^{a)}	Concrete \geq C20/25	c_{min}	50	
		for $s \geq$	150	
Critical spacing for splitting failure	Concrete \geq C20/25	$s_{cr,sp}$	300	
Critical edge distance for splitting failure	Concrete \geq C20/25	$c_{cr,sp}$	150	
Concrete			Non-cracked	Cracked
Critical spacing for concrete cone failure	Concrete \geq C20/25	$s_{cr,N}$	135	75
Critical edge distance for concrete cone failure	Concrete \geq C20/25	$c_{cr,N}$	38	68

a) Linear interpolation allowed

For spacing (edge distance) smaller than critical spacing (critical edge distance) the design loads have to be reduced.

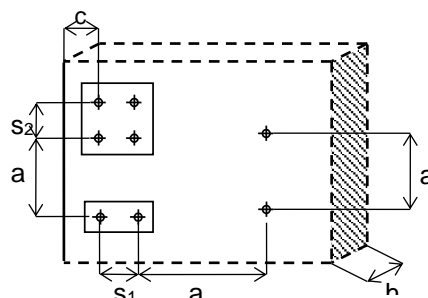

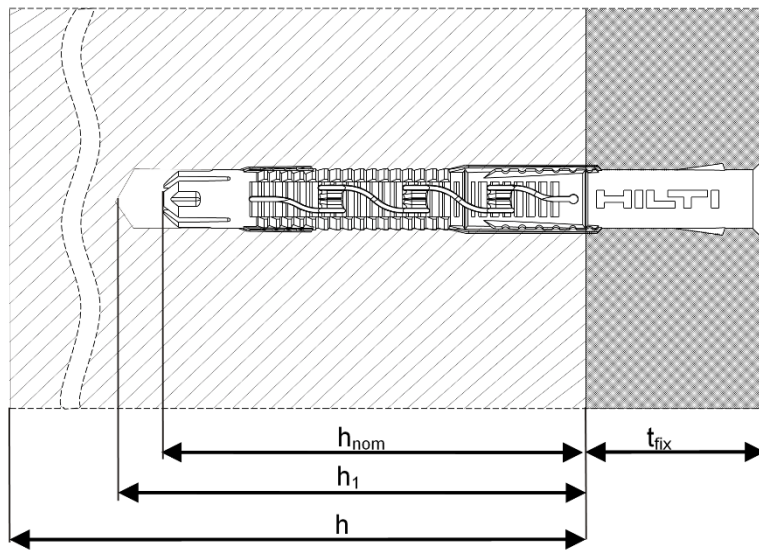

Installation equipment

Anchor size	HRD 10
Rotary hammer	TE 2 (-A) - TE16 (-A)
Other tools	Hammer, Screwdriver

Setting instruction

*For detailed information on installation see instruction for use given with the package of the product.

Setting instruction for HRD	
<p>1. Drilling</p>	<p>2. Cleaning</p>
<p>3. Inserting the anchor</p>	<p>4. Inserting the anchor</p>
<p>5. Setting tools</p>	<p>6. Checking</p>

HRV Plastic anchors

Economical plastic frame anchor

Anchor version



HRV-H
HRV-HF
(M10)

Benefits

- Available in carbon steel and hot-deep galvanized
- Suitable for concrete and steel washers
- Integrated plastic and steel washer

Base material



Concrete
(non-cracked)

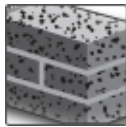

Solid brick

Basic loading data

All data in this section applies to:

- Correct setting (See setting instruction)
- No edge distance and spacing influence
- Non-cracked concrete C16/20 – C50/60, other base material as specified
- Minimum base material thickness
- *Steel failure*
- Shear without lever arm
- Anchor for single point application

Mean ultimate resistance

Anchor size		HRV 10	
		h_{nom}	[mm]
			70
Concrete C16/20 – C50/60		N_{Rum}	[kN]
		V_{Rum}	[kN]
Solid clay brick	$f_b \geq 10 \text{ n/mm}^2$	F_{Rum}	[kN]
	$f_b \geq 20 \text{ n/mm}^2$	F_{Rum}	
Russian solid clay brick	$f_b \geq 10 \text{ n/mm}^2$	F_{Rum}	[kN]
	$f_b \geq 20 \text{ n/mm}^2$	F_{Rum}	[kN]

Characteristic resistance

Anchor size		HRV 10	
		h_{nom}	[mm]
			70
Concrete C16/20 – C50/60		N_{Rk}	[kN]
		V_{Rk}	[kN]
Solid clay brick	$f_b \geq 10 \text{ n/mm}^2$	F_{Rk}	[kN]
	$f_b \geq 20 \text{ n/mm}^2$	F_{Rk}	[kN]
Russian solid clay brick	$f_b \geq 10 \text{ n/mm}^2$	F_{Rk}	[kN]
	$f_b \geq 20 \text{ n/mm}^2$	F_{Rk}	[kN]

Design resistance

Anchor size		HRV 10	
		h_{nom}	[mm]
Concrete C16/20 – C50/60		N_{Rd}	[kN]
		V_{Rd}	[kN]
Solid clay brick	$f_b \geq 10 \text{ n/mm}^2$	F_{Rd}	[kN]
	$f_b \geq 20 \text{ n/mm}^2$	F_{Rd}	[kN]
Russian solid clay brick	$f_b \geq 10 \text{ n/mm}^2$	F_{Rd}	[kN]
	$f_b \geq 20 \text{ n/mm}^2$	F_{Rd}	[kN]

Recommended loads^{a)}

Anchor size		HRV 10	
		h_{nom}	[mm]
Concrete C16/20 – C50/60		N_{Rd}	[kN]
		V_{Rd}	[kN]
Solid clay brick	$f_b \geq 10 \text{ n/mm}^2$	F_{Rd}	[kN]
	$f_b \geq 20 \text{ n/mm}^2$	F_{Rd}	[kN]
Russian solid clay brick	$f_b \geq 10 \text{ n/mm}^2$	F_{Rd}	[kN]
	$f_b \geq 20 \text{ n/mm}^2$	F_{Rd}	[kN]

a) With overall partial safety factor for action $\gamma = 1,4$. The partial safety factors for action depend on the type of loading and shall be taken from national regulations.

Materials



Mechanical properties

Anchor size		HRV 10	
		Galvanized steel	Hot-deep galvanized
Nominal tensile strength f_{uk}	[N/mm ²]	600	600
Yield strength f_{yk}	[N/mm ²]	480	480
Stressed cross-section A_s	tension	27,3	27,3
	shear	28,3	28,3
Moment of resistance W	[mm ³]	21,2	21,2
Char. Bending resistance $M^0_{Rk,s}$	[Nm]	15,3	15,3

Material quality

Part	Material
Sleeve	Polyamide, colour black
Screw	HRV-H
	HRV-HF

Masonry base materials

Solid clay brick	Russian solid clay brick
<p>Mz 1,8 DIN 105-100 / EN 771-1 LxWxH [mm]: 240x115x113 hmin [mm]: 115</p> 	<p>Density [kg/dm³]: 1,9 LxWxH [mm]: 250x120x65 hmin [mm]: 120</p> 

Mechanical properties

Anchor size		HRV 10	
		Galvanized steel	Hot-deep galvanized
Nominal tensile strength f_{uk}	[N/mm ²]	600	600
Yield strength f_{yk}	[N/mm ²]	480	480
Stressed cross-section A_s	tension	27,3	27,3
	shear	28,3	28,3
Moment of resistance W	[mm ³]	21,2	21,2
Char. Bending resistance $M^{0}_{Rk,s}$	[Nm]	15,3	15,3

Anchor dimension

Anchor size			HRV 10
Minimum thickness of fixture	$t_{fix,min}$	[mm]	0
Maximum thickness of fixture	$t_{fix,max}$	[mm]	30
Diameter of the sleeve	d_{nom}	[mm]	10
Minimum length of the sleeve	$l_{1,min}$	[mm]	80
Maximum length of the sleeve	$l_{1,max}$	[mm]	100
Diameter of plastic washer	d_{pw}	[mm]	17,8
Thickness of plastic washer	t_{pw}	[mm]	2,5
Diameter of the screw	d_s	[mm]	7
Minimum length of the screw	$l_{2,min}$	[mm]	75
Maximum length of the screw	$l_{2,max}$	[mm]	105
Head diameter of hexhead screw	d_{sw}	[mm]	17,5

Anchor sleeve

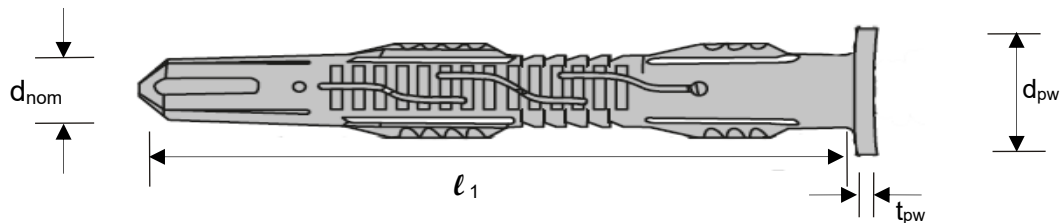

Special screw

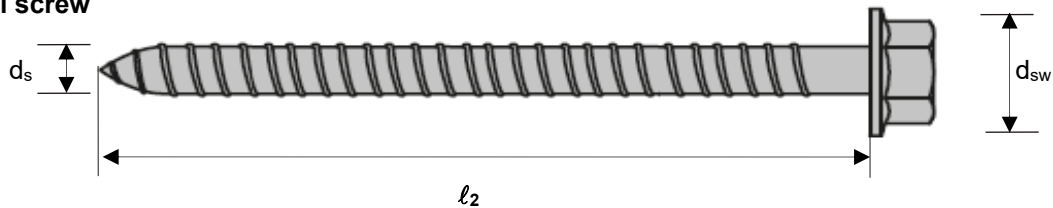

Setting information

Installation temperature

-10°C to +40°C

Service temperature range

Hilti HRV frame anchors may be applied in the temperature range given below.

Temperature range	Base material temperature	Max. long term base material temperature	Max. short term base material temperature
Temperature range	-40 °C to +80 °C	+50 °C	+80 °C

Max short term base material temperature

Short-term elevated base material temperatures are those that occur over brief intervals, e.g. as a result of diurnal cycling.

Max long term base material temperature

Long-term elevated base material temperatures are roughly constant over significant periods of time.

Setting details

Anchor size		HRV 10
Drill hole diameter	d_o [mm]	10
Cutting diameter of drill bit	$d_{cut} \leq$ [mm]	10,45
Depth of drilled hole to deepest point	$h_1 \geq$ [mm]	80
Overall plastic anchor embedment depth in base material	$h_{nom} \geq$ [mm]	70
Diameter of clearance hole in the fixture	$d_f \leq$ [mm]	12

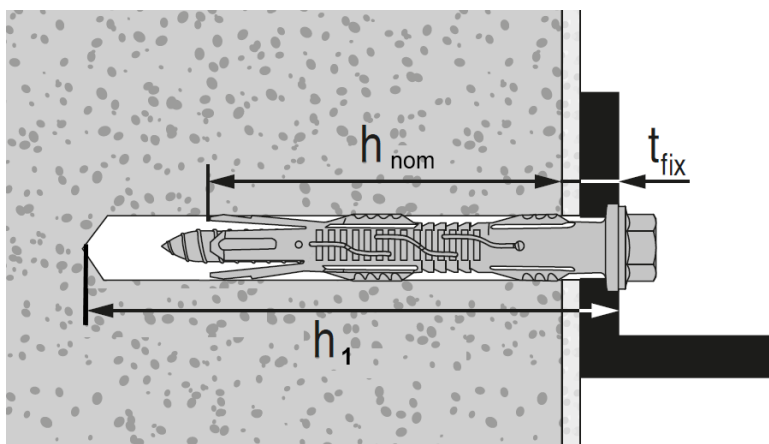

Installation equipment

Anchor size		HRV 10
Rotary hammer		TE 2- TE16
Other tools		Hammer, Screwdriver

Setting parameters

Anchor size		HRV 10
	h_{nom} [mm]	70
Minimum base material thickness	h_{min} [mm]	120
Minimum spacing	s_{min} [mm]	50
	for $c \geq$ [mm]	100 ^{a)}
Minimum edge distance	c_{min} [mm]	50
	for $c \geq$ [mm]	150 ^{a)}
Critical spacing for splitting failure	$s_{cr,sp}$ [mm]	200
Critical edge distance for splitting failure	$c_{cr,sp}$ [mm]	100
Critical spacing for concrete cone failure	$s_{cr,N}$ [mm]	210
Critical edge distance for concrete cone failure	$c_{cr,N}$ [mm]	105

a) Linear interpolation allowed

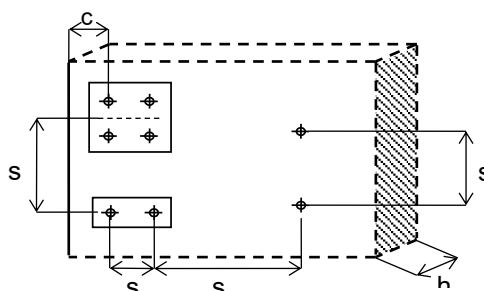

Setting instruction

*For detailed information on installation see instruction for use given with the package of the product.

Setting instruction for HRV

1. Drilling

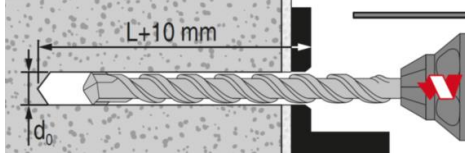

2. Cleaning

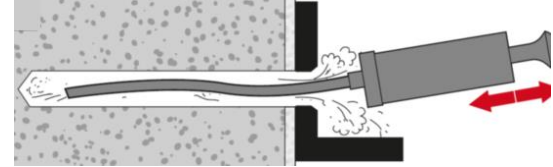

3. Inserting the anchor with hand

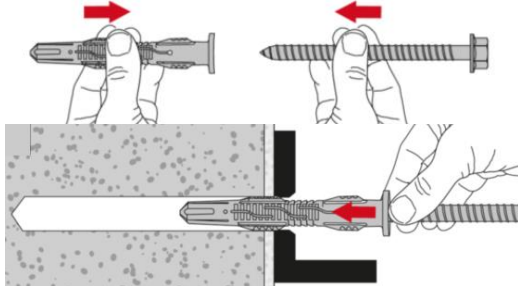

4. Inserting the anchor with hammer

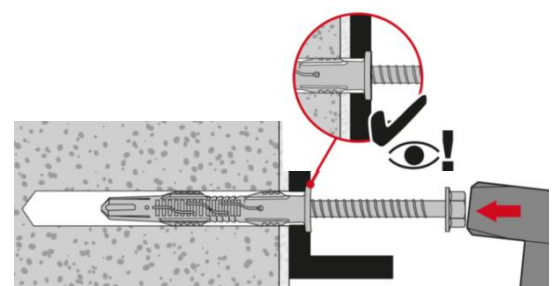

5. Inserting the tools

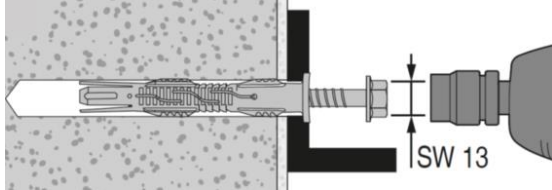

6. Checking

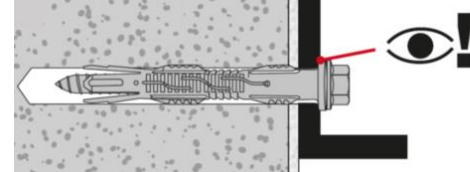

HPS-1 Plastic anchors

Economical plastic impact anchor

Anchor version



HPS-1
(M4-M8)

Benefits

- Impact anchor for light frames, battens and profiles on solid base materials
- Impact and temperature resistant
- High quality plastic

Base material



Concrete
(non-cracked)

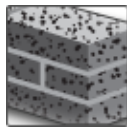

Solid brick

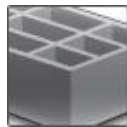

Hollow brick

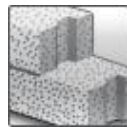

Autoclaved
aerated
concrete

Basic loading data

All data in this section applies to:

- Correct setting (See setting instruction)
- No edge distance and spacing influence
- Base material as specified in the table
- Minimum base material thickness
- Loads shall be reduced if the temperature sustains above 40°C

Recommended loads^{a)}

Anchor size		4/0	5/0	5/5- 5/15	6/0- 6/25	6/30- 6/40	8/0	8/10- 8/40	8/60- 8/100
Concrete ≥ C16/20	N _{Rd} [kN]	0,05	0,10	0,15	0,25	0,25	0,30	0,40	0,40
	V _{Rd} [kN]	0,15	0,30	0,35	0,55	0,35	0,50	0,90	0,50
Engineering brick, 12 hole, class B	N _{Rd} [kN]	0,05	0,10	0,15	0,25	0,25	0,30	0,40	0,40
	V _{Rd} [kN]	0,15	0,30	0,35	0,55	0,35	0,50	0,90	0,50
Perforated brick 3 hole common	N _{Rd} [kN]	0,05	0,10	0,15	0,20	0,20	0,25	0,30	0,30
	V _{Rd} [kN]	0,15	0,30	0,35	0,55	0,35	0,50	0,90	0,55
Thermalite block, 7 N lightweights	N _{Rd} [kN]	-	-	0,08	0,15	0,15	0,20	0,25	0,25
	V _{Rd} [kN]	-	-	0,15	0,25	0,15	0,40	0,40	0,25
Thermalite block, 1/2 N lightweights	N _{Rd} [kN]	-	-	0,05	0,08	0,08	-	0,12	0,12
	V _{Rd} [kN]	-	-	0,10	0,15	0,10	-	0,25	0,15
Autoclaved aerated concrete AAC 4, ACC 6	N _{Rd} [kN]	-	-	0,08	0,10	0,10	-	0,15	0,15
	V _{Rd} [kN]	-	-	0,10	0,12	0,10	-	0,30	0,20
Extruded brick, Boral 10	N _{Rd} [kN]	0,05	0,10	0,15	0,20	0,20	0,25	0,35	0,35
	V _{Rd} [kN]	0,15	0,25	0,30	0,40	0,25	0,50	0,90	0,55

a) With overall global safety factor $\gamma = 5$ to the characteristic loads and a partial safety factor of $\gamma = 1,4$ to the design values.

Materials

Material quality

Part	Material
Plastic sleeve	Polyamide 6.6
Screw	Carbon steel, galvanised to min. 5µm
	Stainless steel, grade A2
	Stainless steel, grade A2, copper-plated

Setting information

Installation temperature

-10 °C to +40°C

Service temperature range

Hilti HPS-1 impact anchor may be applied in the temperature range below.

Temperature range	Base material temperature	Max. long term base material temperature	Max. short term base material temperature
Temperature range	-40 °C to +80 °C	+50 °C	+80 °C

Max. short term base material temperature

Short-term elevated base material temperatures are those that occur over brief intervals, e.g. as a result of diurnal cycling.

Max. long term base material temperature

Long-term elevated base material temperatures are roughly constant over significant periods of time.

Setting details HPS-1

Anchor		HPS-1 4	HPS-1 5	HPS-1 6	HPS-1 8
Nominal diameter of drill bit	d_o [mm]	4	5	6	8
Cutting diameter of drill bit	$d_{cut} \leq$ [mm]	4,35	5,35	6,4	8,45
Depth of drill hole	$h_1 \geq$ [mm]	25	30	40	50
Nominal embedment depth	h_{nom} [mm]	20	20	25	30
Anchor length	l [mm]	21,5	22 - 37	27 - 67	28,5 - 132,5
Max fixture thickness	t_{fix} [mm]	2	15	40	100

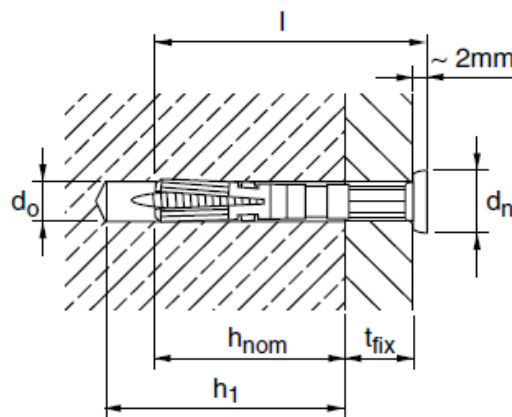

Installation equipment

Anchor	HPS-1 4	HPS-1 5	HPS-1 6	HPS-1 8
Rotary hammer	TE2 - TE16			
Other tools	Screwdriver			

Setting parameters HPS-1

Anchor	HPS-1 4	HPS-1 5	HPS-1 6	HPS-1 8
Spacing s [mm]	20	25	30	35
Edge distance c [mm]	20	25	30	35

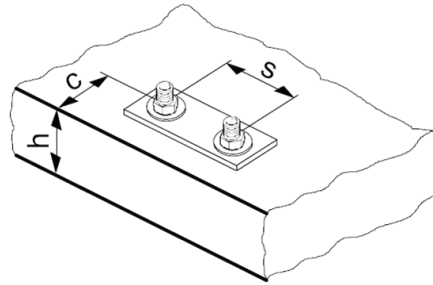

Setting instruction

*For detailed information on installation see instruction for use given with the package of the product.

Setting instructions

<p>1. Drill hole with drill bit</p>	<p>2. Install anchor</p>	<p>3. Hammer in anchor</p>
--	---------------------------------	-----------------------------------

HUD-1 Plastic anchor

Economical universal plastic anchor

Anchor version



HUD-1
(M5-M14)

Benefits

- Flat setting
- Flexibility of screw length
- An anchor for every base material

Base material



Concrete
(non-cracked)

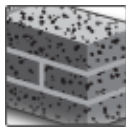

Solid brick

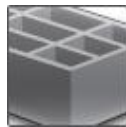

Hollow brick

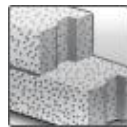

Autoclaved
aerated
concrete



Drywall

Basic loading data

All data in this section applies to:

- Correct setting (See setting instruction)
- Load data are only valid for the specified woodscrew type
- No edge distance and spacing influence
- Base material as specified in the table
- Minimum base material thickness

Characteristic resistance

Anchor size		5x25		6x30		8x40		10x50		12x60	14x70
Screw type ^{d)}		W	C	W	C	W	C	W	C	W	W
Size		4	4	5	5	6	6	8	8	10	12
DIN		96		96		96		96		571	571
Concrete ≥ C16/20	N _{Rk} [kN]	1,5	0,5	2,75	1,75	4,25	2,5	7	-	10	15
	V _{Rk} [kN]	2	-	4,5	-	6,25	-	11	-	15	28
Solid clay brick Mz 20	N _{Rk} [kN]	0,85	0,3	1,75	0,75	3	1,75	4	-	5	5 ^{a)}
	V _{Rk} [kN]	1,2	-	1,5	-	2,2	-	-	-	-	-
Solid sand-lime brick KS 12	N _{Rk} [kN]	1,25	0,75	2,5	1,5	4,25	2	5	-	7,5	7,5 ^{a)}
	V _{Rk} [kN]	1,25	-	2,8	-	3,7	-	6,6	-	-	-
Hollow clay brick HlzB 12	N _{Rk} [kN]	0,4	0,25	0,5	0,4	1	0,6	1,25	-	1,4	1,6
	V _{Rk} [kN]	1,15	-	1,75	-	-	-	-	-	-	-
Hollow clay brick HlzB 12 – 15mm plastered	N _{Rk} [kN]	0,4	0,25	0,75	0,5	1,25	0,75	1,5	-	1,75	2
	V _{Rk} [kN]	1,15	-	1,75	-	-	-	-	-	-	-
Autoclaved aerated concrete AAC 2	N _{Rk} [kN]	0,3	0,2	0,5	0,3	0,75	0,5	1	-	1,25	1,5
	V _{Rk} [kN]	0,2	-	0,25	-	0,4	-	-	-	-	-
Autoclaved aerated concrete AAC 4	N _{Rk} [kN]	0,5	0,3	0,75	0,5	1,5	1	2	-	2,5	3
	V _{Rk} [kN]	0,65	-	0,9	-	1,5	-	-	-	-	-
Gypsum board Thickness 12,5mm	N _{Rk} [kN]	0,2	0,3	0,25	0,4	0,3	0,5	-	0,75 ^{b)}	-	-
	V _{Rk} [kN]	0,45	-	0,7	-	-	-	-	-	-	-
Gypsum board Thickness 2x12,5mm	N _{Rk} [kN]	0,3	0,3	0,4	0,4	0,5	0,5	0,75 ^{b)}	1 ^{b)}	1,5 ^{c)}	-
	V _{Rk} [kN]	0,45	-	0,7	-	-	-	-	-	-	-
Fibre reinforced gypsum board Thickness 12,5mm	N _{Rk} [kN]	0,45	-	0,6	-	0,9	-	-	-	-	-
	V _{Rk} [kN]	0,72	-	0,96	-	1,44	-	-	-	-	-
Fibre reinforced gypsum board Thickness 2x12,5mm	N _{Rk} [kN]	0,45	-	1,2	-	1,8	-	2,1	-	-	-
	V _{Rk} [kN]	0,72	-	1,92	-	2,88	-	3,36	-	-	-

a) only with screw diameter 6mm

b) only with screw diameter 8mm

c) only with screw diameter 10mm

d) Screw type: W: Wood-screw C: Chipboard screw

Load data are valid for the mentioned woodscrew type, if other types or different screws are used the load capacity may decrease.

Design resistance

Anchor size		5x25		6x30		8x40		10x50		12x60	14x70
Screw type ^{d)}		W	C	W	C	W	C	W	C	W	W
Size		4	4	5	5	6	6	8	8	10	12
DIN		96		96		96		96		571	571
Concrete ≥ C16/20	N _{Rd} [kN]	0,42	0,14	0,77	0,49	1,19	0,70	1,96	-	2,80	4,20
	V _{Rd} [kN]	0,56	-	1,26	-	1,75	-	3,08	-	4,20	7,84
Solid clay brick Mz 20	N _{Rd} [kN]	0,24	0,08	0,49	0,21	0,84	0,49	1,12	-	1,40	1,40 ^{c)}
	V _{Rd} [kN]	0,34	-	0,42	-	0,62	-	-	-	-	-
Solid sand-lime brick KS 12	N _{Rd} [kN]	0,35	0,21	0,70	0,42	1,19	0,56	1,40	-	2,10	2,10 ^{c)}
	V _{Rd} [kN]	0,35	-	0,78	-	1,04	-	1,85	-	-	-
Hollow clay brick HlzB 12	N _{Rd} [kN]	0,11	0,07	0,14	0,11	0,28	0,17	0,35	-	0,39	0,45
	V _{Rd} [kN]	0,32	-	0,49	-	-	-	-	-	-	-
Hollow clay brick HlzB 12 – 15mm plastered	N _{Rd} [kN]	0,11	0,07	0,21	0,14	0,35	0,21	0,42	-	0,49	0,56
	V _{Rd} [kN]	0,32	-	0,49	-	-	-	-	-	-	-
Autoclaved aerated concrete AAC 2	N _{Rd} [kN]	0,08	0,06	0,14	0,08	0,21	0,14	0,28	-	0,35	0,42
	V _{Rd} [kN]	0,06	-	0,07	-	0,11	-	-	-	-	-
Autoclaved aerated concrete AAC 4	N _{Rd} [kN]	0,14	0,08	0,21	0,14	0,42	0,28	0,56	-	0,70	0,84
	V _{Rd} [kN]	0,18	-	0,25	-	0,42	-	-	-	-	-
Gypsum board Thickness 12,5mm	N _{Rd} [kN]	0,06	0,08	0,07	0,11	0,08	0,14	-	0,21 ^{a)}	-	-
	V _{Rd} [kN]	0,13	-	0,20	-	-	-	-	-	-	-
Gypsum board Thickness 2x12,5mm	N _{Rd} [kN]	0,08	0,08	0,11	0,11	0,14	0,14	0,21 ^{a)}	0,28 ^{a)}	0,42 ^{b)}	
	V _{Rd} [kN]	0,13	-	0,20	-	-	-	-	-	-	-
Fibre reinforced gypsum board Thickness 12,5mm	N _{Rd} [kN]	0,13	-	0,17	-	0,25	-	-	-	-	-
	V _{Rd} [kN]	0,20	-	0,27	-	0,40	-	-	-	-	-
Fibre reinforced gypsum board Thickness 2x12,5mm	N _{Rd} [kN]	0,13	-	0,34	-	0,50	-	0,59	-	-	-
	V _{Rd} [kN]	0,20	-	0,54	-	0,81	-	0,94	-	-	-

a) only with screw diameter 6mm

b) only with screw diameter 8mm

c) only with screw diameter 10mm

d) Screw type: W: Wood-screw C: Chipboard screw

Load data are valid for the mentioned woodscrew type, if other types or different screws are used the load capacity may decrease.

Recommended loads^{e)}

Anchor size		5x25		6x30		8x40		10x50		12x60	14x70
Screw type ^{d)}		W	C	W	C	W	C	W	C	W	W
Concrete ≥ C16/20	N _{Rec} [kN]	0,3	0,1	0,55	0,35	0,85	0,5	1,4	-	2	3
	V _{Rec} [kN]	0,4	-	0,9	-	1,25	-	2,2	-	3	5,6
Solid clay brick Mz 20	N _{Rec} [kN]	0,17	0,06	0,35	0,15	0,6	0,35	0,8	-	1	1
	V _{Rec} [kN]	0,24	-	0,3	-	0,44	-	-	-	-	-
Solid sand-lime brick KS 12	N _{Rec} [kN]	0,25	0,15	0,5	0,3	0,85	0,4	1	-	1,5	1,5
	V _{Rec} [kN]	0,25	-	0,56	-	0,74	-	1,32	-		
Hollow clay brick HlzB 12	N _{Rec} [kN]	0,08	0,05	0,1	0,08	0,2	0,12	0,25	-	0,28	0,32
	V _{Rec} [kN]	0,23	-	0,35	-	-	-	-	-	-	-
Hollow clay brick HlzB 12 – 15mm plastered	N _{Rec} [kN]	0,08	0,05	0,15	0,1	0,25	0,15	0,3	-	0,35	0,4
	V _{Rec} [kN]	0,23	-	0,35	-	-	-	-	-	-	-
Autoclaved aerated concrete AAC 2	N _{Rec} [kN]	0,06	0,04	0,1	0,06	0,15	0,1	0,2	-	0,25	0,3
	V _{Rec} [kN]	0,04	-	0,05		0,08			-		
Autoclaved aerated concrete AAC 4	N _{Rec} [kN]	0,1	0,06	0,15	0,1	0,3	0,2	0,4	-	0,5	0,6
	V _{Rec} [kN]	0,13	-	0,18	-	0,3	-	-	-	-	-
Gypsum board Thickness 12,5mm	N _{Rec} [kN]	0,04	0,06	0,05	0,08	0,06	0,1	-	0,15	-	-
	V _{Rec} [kN]	0,09	-	0,14	-	-	-	-	-	-	-
Gypsum board Thickness 2x12,5mm	N _{Rec} [kN]	0,06	0,06	0,08	0,08	0,1	0,1	0,15	0,2	0,3	-
	V _{Rec} [kN]	0,09	-	0,14	-	-	-	-	-	-	-
Fibre reinforced gypsum board Thickness 12,5mm	N _{Rec} [kN]	0,09	-	0,12	-	0,18	-	-	-	-	-
	V _{Rec} [kN]	0,14	-	0,19	-	0,29	-	-	-	-	-
Fibre reinforced gypsum board Thickness 2x12,5mm	N _{Rec} [kN]	0,09	-	0,24	-	0,36	-	0,42	-	-	-
	V _{Rec} [kN]	0,14	-	0,38	-	0,58	-	0,67	-	-	-

a) only with screw diameter 6mm

b) only with screw diameter 8mm

c) only with screw diameter 10mm

d) Screw type: W: Wood-screw C: Chipboard screw

Load data are valid for the mentioned woodscrew type, if other types or different screws are used the load capacity may decrease.

e) With overall global safety factor $\gamma = 5$ to the characteristic loads and a partial safety factor of $\gamma = 1,4$ to the design values.

Materials
Material quality

Part	Material
Plastic sleeve	Polyamide 6

Setting information

Service temperature range

Hilti HUD-1 universal anchor may be applied in the temperature range given below.

Temperature range	Base material temperature	Max. long term base material temperature	Max. short term base material temperature
Temperature range	-40 °C to +80 °C	+50 °C	+80 °C

Max short term base material temperature

Short-term elevated base material temperatures are those that occur over brief intervals, e.g. as a result of diurnal cycling.

Max long term base material temperature

Long-term elevated base material temperatures are roughly constant over significant periods of time.

Setting details

Anchor size		5x25	6x30	8x40	10x50	12x60	14x70
Nominal diameter of drill bit	d_o [mm]	5	6	8	10	12	14
Cutting diameter of drill bit	$d_{cut} \leq$ [mm]	5,35	6,4	8,45	10,45	12,5	14,5
Depth of drill hole	$h_1 \geq$ [mm]	35	40	55	65	80	90
Effective anchorage depth	h_{nom} [mm]	25	30	40	50	60	70
Anchor length	l [mm]	25	30	40	50	60	70
Max fixture thickness	t_{fix} [mm]	Depending on screw length					
Installation temperature	[°C]	-10 to +40					
Woodscrew diameter ^{a)}	d [mm]	3,5 - 4	4,5 - 5	5 - 6	7 - 8	8 - 10	10 - 12

a) The basic loading data are depending on the woodscrew diameters, if other types or different screws are used the load capacity may decrease. Highlighted diameters refer to basic loading data table, except footnotes ^{a), b), c)} of basic loading data tables.

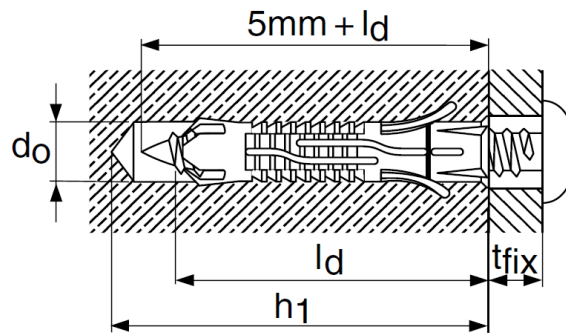

Installation equipment

Anchor size	5x25	6x30	8x40	10x50	12x60	14x70	5x25
Rotary hammer	TE 2- TE16						
Other tools	Screwdriver						

Setting instruction^{a)}

*For detailed information on installation see instruction for use given with the package of the product.

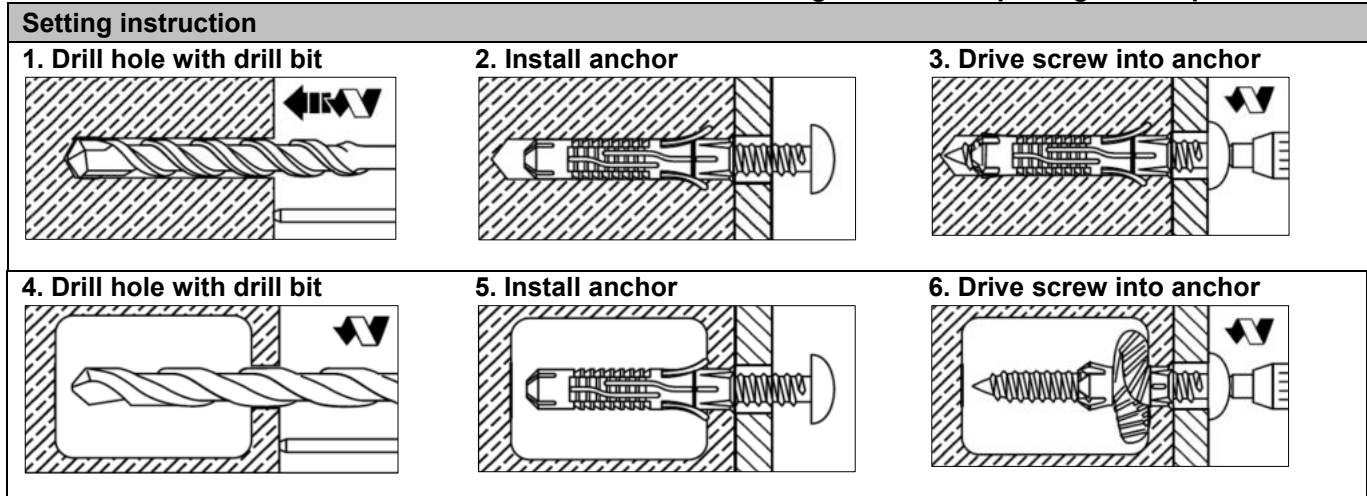

a) Use only for wall and floor applications. Not applicable for ceiling and façade applications.

HUD-L Plastic anchors

Economical universal long plastic anchor

Anchor version



HUD-L
(M6-M8)



HUD-L
(M10)

Benefits

- Universal plastic anchor for weak base materials and renovation
- For many base materials
- Daily application
- Excellent setting behaviour

Base material



Concrete

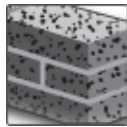

Solid brick

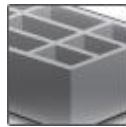

Hollow brick

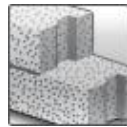

Autoclaved
aerated
concrete



Drywall

Basic loading data

All data in this section applies to:

- Correct setting (See setting instruction)
- Load data are only valid for the specified woodscrew type
- Load data given in the tables is independent of load direction
- No edge distance and spacing influence
- Base material as specified in the table
- Minimum base material thickness

Characteristic resistance

Anchor size		6x50	8x60	10x70
Screw type ^{c) d)}		W	W	W
Size		4,5x80	5x90	8
DIN		96	96	571
Concrete \geq C16/20	F_{Rk} [kN]	1,15	1,4	9,0
Solid clay brick Mz 12	F_{Rk} [kN]	0,85	1,0	-
Solid clay brick Mz 20	F_{Rk} [kN]	-	-	7,0
Solid sand-lime brick KS 12	F_{Rk} [kN]	0,85	1,0	2
Hollow clay brick Hlz 12 ^{a)}	F_{Rk} [kN]	0,5	0,75	1,5
Hollow sand-lime brick KSL 12	F_{Rk} [kN]	0,7	0,8	-
Autoclaved aerated concrete AAC 2 ^{a)}	F_{Rk} [kN]	0,25	0,55	2,0
Gypsum board Thickness 2x12,5mm ^{a)}	F_{Rk} [kN]	0,3	0,7	0,6 ^{b)}

a) Drilling without hammering

b) Suitable for fitting hexagonal screws by hand

c) Load data are valid for the mentioned woodscrew type, if other types or different screws are used the load capacity may decrease.

d) Screw type: W: Wood-screw

Design resistance

Anchor size		6x50	8x60	10x70
Screw type ^{c) d)}		W	W	W
Size		4,5x80	5x90	8
DIN		96	96	571
Concrete \geq C16/20	F_{Rd} [kN]	0,32	0,39	2,52
Solid clay brick Mz 12	F_{Rd} [kN]	0,24	0,28	-
Solid clay brick Mz 20	F_{Rd} [kN]	-	-	1,96
Solid sand-lime brick KS 12	F_{Rd} [kN]	0,24	0,28	0,56
Hollow clay brick Hlz 12 ^{a)}	F_{Rd} [kN]	0,14	0,21	0,42
Hollow sand-lime brick KSL 12	F_{Rd} [kN]	0,20	0,22	-
Autoclaved aerated concrete AAC 2 ^{a)}	F_{Rd} [kN]	0,07	0,15	0,56
Gypsum board Thickness 2x12,5mm ^{a)}	F_{Rd} [kN]	0,08	0,20	0,17 ^{b)}

a) Drilling without hammering

b) Suitable for fitting hexagonal screws by hand

c) Load data are valid for the mentioned woodscrew type, if other types or different screws are used the load capacity may decrease.

d) Screw type: W: Wood-screw

Recommended loads ^{e)}

Anchor size		6x50	8x60	10x70
Screw type ^{c) d)}		W	W	W
Size		4,5x80	5x90	8
DIN		96	96	571
Concrete \geq C16/20	F_{Rec} [kN]	0,23	0,28	1,8
Solid clay brick Mz 12	F_{Rec} [kN]	0,17	0,2	-
Solid clay brick Mz 20	F_{Rec} [kN]	-	-	1,4
Solid sand-lime brick KS 12	F_{Rec} [kN]	0,17	0,2	0,4
Hollow clay brick Hlz 12 ^{a)}	F_{Rec} [kN]	0,1	0,15	0,3
Hollow sand-lime brick KSL 12	F_{Rec} [kN]	0,14	0,16	-
Autoclaved aerated concrete AAC 2 ^{a)}	F_{Rec} [kN]	0,05	0,11	0,4
Gypsum board Thickness 2x12,5mm ^{a)}	F_{Rec} [kN]	0,06	0,14	0,12 ^{b)}

a) Drilling without hammering

b) Suitable for fitting hexagonal screws by hand

c) Load data are valid for the mentioned woodscrew type, if other types or different screws are used the load capacity may decrease.

d) Screw type: W: Wood-screw

e) With overall global safety factor $\gamma = 5$ to the characteristic loads and a partial safety factor of $\gamma = 1,4$ to the design values.

Materials

Material quality

Part	Material
Plastic sleeve	Polyamide 6

Setting information

Installation temperature

-10°C to + 40°C

Service temperature range

Hilti HUD-L universal anchor may be applied in the temperature range given below.

Temperature range	Base material temperature	Max. long term base material temperature	Max. short term base material temperature
Temperature range	-40 °C to +80 °C	+50 °C	+80 °C

Max short term base material temperature

Short-term elevated base material temperatures are those that occur over brief intervals, e.g. as a result of diurnal cycling.

Max long term base material temperature

Long-term elevated base material temperatures are roughly constant over significant periods of time.

Anchor size		6x50	8x60	10x70
Nominal diameter of drill bit	d_o [mm]	6	8	10
Cutting diameter of drill bit	$d_{cut} \leq$ [mm]	6,4	8,45	10,45
Depth of drill hole	$h_1 \geq$ [mm]	70	80	90
Effective anchorage depth	h_{nom} [mm]	47	57	70
Anchor length	l [mm]	47	57	70
Max fixture thickness	t_{fix} [mm]	Depending on screw length		
Recommended length of screw in base material	l_d [mm]	55	65	75
Woodscrew diameter ^{a)}	d [mm]	4,5 - 5	5 - 6	7 - 8

a) The basic loading data are depending on the woodscrew diameters, if other types or different screws are used the load capacity may decrease. Highlighted diameters refer to basic loading data table, except footnotes ^{a), b), c)} of basic loading data tables.

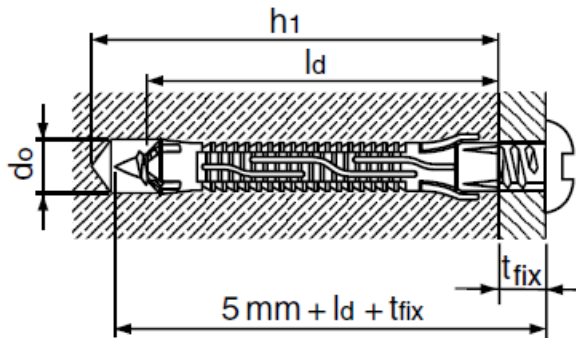

Installation equipment

Anchor size	6x50	8x60	10x70
Rotary hammer		TE 2- TE16	
Other tools		Screwdriver	

Setting instruction ^{a)}

*For detailed information on installation see instruction for use given with the package of the product.

Setting instruction		
1. Drill hole with drill bit 	2. Install anchor 	3. Put part being fastened in place and drive screw into anchor.
4. Drill hole with drill bit 	5. Put part being fastened in place and install anchor 	6. Drive screw into anchor

a) Use only for wall and floor applications. Not applicable for ceiling and façade applications.

HLD Plastic anchors

Economical plastic anchor for drywall

Anchor version



HLD
(M10)

Benefits

- Plastic undercut anchor
- Simple setting
- Drywall application

Base material



Drywall

Basic loading data

All data in this section applies to:

- Correct setting (See setting instruction)
- No edge distance and spacing influence
- Base material as specified in the table
- Load data given in the tables is independent of load direction

Characteristic resistance

Anchor size	Anchoring principle ^{a)}			HLD 2	HLD 3	HLD 4
Gypsum board Thickness 12,5mm	B	F_{Rk}	[kN]	0,4	0,4	0,4
Fibre reinforced gypsum board	A	F_{Rk}	[kN]	0,3	-	-
Fibre reinforced gypsum board Thickness 2x12,5mm	A	F_{Rk}	[kN]	-	0,6	-
Hollow clay brick	A / B	F_{Rk}	[kN]	0,75	0,75	
Concrete \geq C16/20	C	F_{Rk}	[kN]	1,25	2	2,5

a) See setting details

Design resistance

Anchor size	Anchoring principle ^{a)}			HLD 2	HLD 3	HLD 4
Gypsum board Thickness 12,5mm	B	F_{Rd}	[kN]	0,11	0,11	0,11
Fibre reinforced gypsum board	A	F_{Rd}	[kN]	0,08	-	-
Fibre reinforced gypsum board Thickness 2x12,5mm	A	F_{Rd}	[kN]	-	0,17	-
Hollow clay brick	A / B	F_{Rd}	[kN]	0,21	0,21	-
Concrete \geq C16/20	C	F_{Rd}	[kN]	0,35	0,56	0,70

a) See setting detail

Recommended loads ^{b)}

Anchor size			HLD 2	HLD 3	HLD 4
Anchoring principle ^{a)}					
Gypsum board Thickness 12,5mm	B	F _{Rec} [kN]	0,08	0,08	0,08
Fibre reinforced gypsum board	A	F _{Rec} [kN]	0,06	-	-
Fibre reinforced gypsum board Thickness 2x12,5mm	A	F _{Rec} [kN]	-	0,12	-
Hollow clay brick	A / B	F _{Rec} [kN]	0,15	0,15	
Concrete ≥ C16/20	C	F _{Rec} [kN]	0,25	0,4	0,5

a) See setting details

b) With overall global safety factor $\gamma = 5$ to the characteristic loads and a partial safety factor of $\gamma = 1,4$ to the design value.

Materials

Material quality

Part	Material
Sleeve	Polyamide PA 6

Setting information

Installation temperature

-10°C to + 40°C

Service temperature range

Hilti HLD universal anchor may be applied in the temperature range given below.

Temperature range	Base material temperature	Max. long term base material temperature	Max. short term base material temperature
Temperature range	-40 °C to +80 °C	+50 °C	+80 °C

Max short term base material temperature

Short-term elevated base material temperatures are those that occur over brief intervals, e.g. as a result of diurnal cycling.

Max long term base material temperature

Long-term elevated base material temperatures are roughly constant over significant periods of time.

Setting details

Anchor size			HLD 2	HLD 3	HLD 4
Nominal diameter of drill bit	d _o	[mm]	10		
Depth of drill hole	(only anchoring principle C)	h ₁ ≥ [mm]	50	56	66
Screw length	(anchoring principle A/B)	l _s [mm]	33 + t _{fix}	40 + t _{fix}	49 + t _{fix}
	(anchoring principle C)	l _s [mm]	40 + t _{fix}	46 + t _{fix}	56 + t _{fix}
Screw diameter	(anchoring principle A/B)	d _s [mm]	4 - 5		
	(anchoring principle C)	d _s [mm]	5 - 6		
Wall / panel thickness	(anchoring principle A)	h [mm]	4 - 12	15 - 19	24 - 28
	(anchoring principle B)	h [mm]	12 - 16	19 - 25	28 - 32
	(anchoring principle C)	h	35	42	50

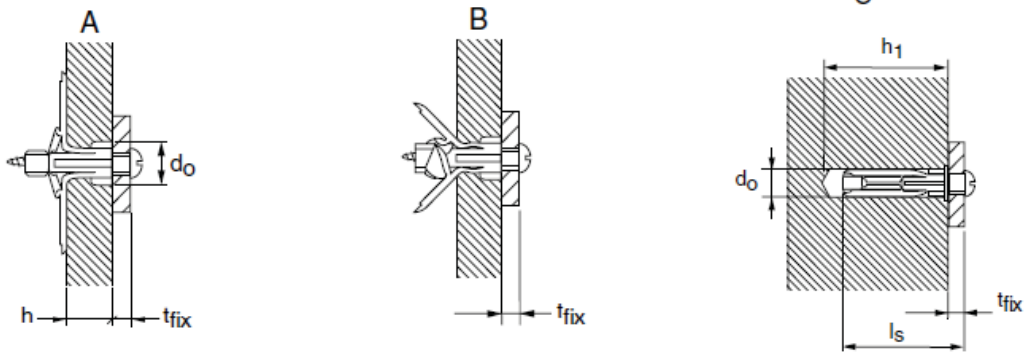

Installation equipment

Anchor size	HLD 2	HLD 3	HLD 4
Rotary hammer	TE 2- TE16		
Other tools	Screwdriver		





Setting instruction



*For detailed information on installation see instruction for use given with the package of the product.

Setting instruction	
1. Drill hole with drill bit 	2. Install anchor
3. Install anchor 	4. Drive in the screw

HMF plastic anchor

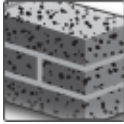
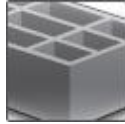
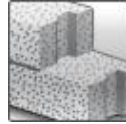

Economical universal plastic anchor

Anchor version		Benefits
	HMF	- Flat setting - An anchor for every base material
	CS: Countersunk screw	- Suitable for fastening through in-place parts - Resists rotation in hole and premature expansion
	PH: Pan head screw	- High reliability and precise screw guidance, 360° expansion
	HH: Hexagonal head screw	

Base material				
				
Concrete (non-cracked)	Solid brick	Hollow brick	Autoclaved aerated concrete	Drywall

Basic loading data
<p>All data in this section applies to:</p> <ul style="list-style-type: none"> - Correct setting (See setting instruction) - Load data are only valid for the specified screw types - No edge distance and spacing influence - Base material as specified in the table - Minimum base material thickness

Recommended loads ^{a)} for all load directions

Anchor size		HMF 5x25	HMF 6x30	HMF 8x40	HMF 10x50	HMF 12x60	HMF 14x70
Screw type ^{b)}		CS F PH 4	CS 4,5 PH 4,5	CS 5 PH 5 HH 5	CS 7 PH 7 HH 7	HH 8	HH 10
Non-cracked concrete \geq C16/20	F_{Rec} [kN]	0,25	0,30	0,40	1,00	1,40	1,40
Solid clay brick size: 230x110x60 strength: $f_{c,test} \geq 20$ [N/mm ²] density: 2000 [kg/m ³]	F_{Rec} [kN]	0,15	0,15	0,20	0,80	0,80	0,80
Autoclaved aerated concrete AAC2 size: 600x175x200 strength: 2 [N/mm ²] density: 390[kg/m ³]	F_{Rec} [kN]	0,02	0,04	0,05	0,10	0,15	0,15
Autoclaved aerated concrete AAC4 size: 625x250x250 strength: 4,0 [N/mm ²] density: 600 [kg/m ³]	F_{Rec} [kN]	0,04	0,06	0,10	0,18	0,18	0,22
Hollow clay brick type: Tramezza "Tavella" manufacturer: Fornace Tempora size: 200x250x30 strength: 25 [N/mm ²] density: 2000 [kg/m ³]	 F_{Rec} [kN]	0,10	0,10	0,20	0,20	N/A ^{c)}	0,35
Hollow clay brick type: "Doppio Uni" manufacturer: Fornace S. Antonio size: 120x120x240 strength: 20 [N/mm ²] density: 2000 [kg/m ³]	 F_{Rec} [kN]	0,10	0,10	0,15	0,25	0,45	0,45
Hollow clay brick type: Poroton "Blocchi portanti" manufacturer: Fornace S. Antonio size: 300x200x200 strength: 10 [N/mm ²] density: 2000 [kg/m ³]	 F_{Rec} [kN]	0,10	0,10	0,10	0,20	0,20	0,20
Hollow clay brick type: Pignata "Blocchi intermedi" manufacturer: Fornace S. Antonio size: 120x120x240 strength: 25 [N/mm ²] density: 2000 [kg/m ³]	 F_{Rec} [kN]	0,10	0,10	0,10	0,25	N/A ^{c)}	N/A ^{c)}
Drywall manufacturer: Knauf size: thickness 12,5 [mm] density: 680 [kg/m ³]	F_{Rec} [kN]	0,02 ^{d)}	0,04	0,04	0,04	N/A ^{c)}	N/A ^{c)}
Drywall with fibers manufacturer: Knauf size: thickness 12,5 [mm] density: 1200 [kg/m ³]	F_{Rec} [kN]	0,03	0,20	0,20	0,20	0,35	0,35

- a) Performance assessment based on statistical evaluation of the ultimate loads, including the effect of drill bit wear, conditioning and different installation and in-service temperatures, load-displacement behaviour and scatter of the results. Based on that assessment a partial safety concept is used with $\gamma_{M,concrete} = 1,8$; $\gamma_{M,AAC} = 2,1$; $\gamma_{M,masonry} = 2,5$ additional load safety factor of $\gamma_{G,Q} = 1,4$.
- b) CS: Countersunk, PH: Pan head, HH hexagonal head; screws are specified by Hilti and can be ordered with the plastic body.
- c) Not applicable
- d) Shear load only

Materials

Material quality

Part	Material
Plastic sleeve	Polyamide 6
Screw	Carbon steel, galvanized $\geq 5 \mu\text{m}$

Setting information

Installation temperature

-10°C to +40°C

In service temperature range

Hilti HMF universal plastic anchor may be applied in the temperature range given below.

Temperature in base material

Temperature range	Base material temperature	Max. long term base material temperature	Max. short term base material temperature
Temperature range I	-40 °C to +80 °C	+50 °C	+80 °C

Max short term base material temperature

Short-term elevated base material temperatures are those that occur over brief intervals, e.g. as a result of diurnal cycling.

Max long term base material temperature

Long-term elevated base material temperatures are roughly constant over significant periods of time.

Setting details

Anchor size		HMF 5x25	HMF 6x30	HMF 8x40	HMF 10x50	HMF 12x60	HMF 14x70
Screw type ^{b)}		CS 4 PH 4	CS 4,5 PH 4,5	CS 5 PH 5 HH 5	CS 7 PH 7 HH 7	HH 8	HH 10
Nominal diameter of drill bit	d_o [mm]	5	6	8	10	12	14
Cutting diameter of drill bit	d_{cut} [mm]	5,35	6,4	8,45	10,45	12,5	14,5
Depth of drill hole	$h_1 \geq$ [mm]	35	40	50	70	80	90
Nominal anchorage depth	h_{nom} [mm]	25	30	40	50	60	70
Anchor length	l_d [mm]	25	30	40	50	60	70
Diameter of clearance hole in the fixture	$d_f \leq$ [mm]	5,5	6,5	8,5	11	13	15
Length of the screw	[mm]	35	40	50	60	70	80
Drive configuration		Pz2	Pz2	Pz2/T30	T30	T30	T30
Hexhead diameter	[mm]	-	-	8	10	10	13
Max fixture thickness	t_{fix} [mm]	5	5	5	5	5	5
Min. edge distance in concrete	c_{min} [mm]	50	50	50	50	50	50

b) CS: Countersunk, PH: Pan head, HH hexagonal head; screws are specified by Hilti and can be ordered with the plastic body.

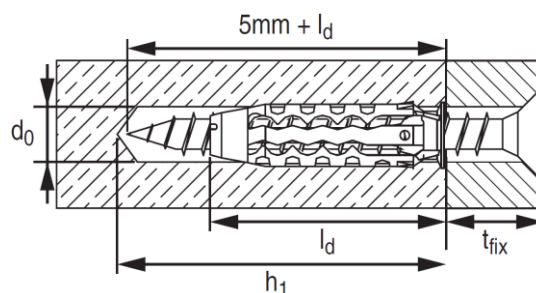

Installation equipment

Anchor size	HMF	5x25	6x30	8x40	10x50	12x60	14x70
Rotary hammer					TE 2- TE16		
Other tools					Screwdriver		

Setting instruction

*For detailed information on installation see instruction for use given with the package of the product.

Setting instruction	
1. Drill hole with drill bit 	2. Insert the anchor
3. Drive screw into anchor 	4a. Drive screw into anchor in concrete
4b. Drive screw into anchor in drywall 	4c. Drive screw into anchor in solid brick
4d. Drive screw into anchor in hollow brick 	

GD 14 + GRS 12 Plastic anchors

Economical plastic scaffolding anchor

Anchor version



GD 14 (anchor body)
GRS 12 (screw)
(M14)

Benefits

- Available in carbon steel and hot-dipped galvanized
- Integrated plastic and steel washer

Base material



Concrete
(non-cracked)

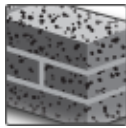

Solid brick

Basic loading data

All data in this section applies to:

- Correct setting (See setting instruction)
- Load data are only valid for the specified screw
- No edge distance and spacing influence
- Minimum base material thickness

Design resistance ^{a) b)}

Anchor size		GD 14					
		GDS 12x90	GDS 12x120	GDS 12x160	GDS 12x190	GDS 12x230	GDS 12x350
Concrete C16/20 – C50/60	N_{Rd} [kN]	4,2					
	V_{Rd} [kN]	2,8	2,5	1,0	0,6	0,35	0,13
Solid clay brick Mz 12-2.0	N_{Rd} [kN]	1,9					
	V_{Rd} [kN]	1,0	1,0	1,0	0,6	0,35	0,13
Solid sand-lime brick KS 12-2.0	N_{Rd} [kN]	1,3					
	V_{Rd} [kN]	0,7	0,7	0,7	0,6	0,35	0,35

a) With partial safety factor $\gamma = 1,8$ for concrete and $\gamma = 2,5$ for masonry (acc. ETAG 020).

b) Shear load data are determined from the lower value of anchor load capacity in the base material and the serviceability load that ensures a maximum bending of the screw of 1/50 of its lever arm.

Recommended load ^{a) b)}

Anchor size		GD 14					
		GDS 12x90	GDS 12x120	GDS 12x160	GDS 12x190	GDS 12x230	GDS 12x350
Concrete C16/20 – C50/60	N_{Rd} [kN]	2,8					
	V_{Rd} [kN]	1,8	1,7	0,65	0,4	0,23	0,09
Solid clay brick Mz 12-2.0	N_{Rd} [kN]	1,3					
	V_{Rd} [kN]	0,65	0,65	0,65	0,4	0,23	0,09
Solid sand-lime brick KS 12-2.0	N_{Rd} [kN]	0,85					
	V_{Rd} [kN]	0,5	0,5	0,5	0,4	0,23	0,09

a) With partial safety factor $\gamma = 1,8$ for concrete and $\gamma = 2,5$ for masonry (acc. ETAG 020).

b) Shear load data are determined from the lower value of anchor load capacity in the base material and the serviceability load that ensures a maximum bending of the screw of 1/50 of its lever arm.

Materials

Material quality

Part	Material
Plastic sleeve	Polyamide

Setting information

Installation temperature

-10°C to +40°C

Service temperature range

Hilti GD frame anchors may be applied in the temperature range given below.

Temperature range	Base material temperature	Max. long term base material temperature	Max. short term base material temperature
Temperature range	-40 °C to +80 °C	+50 °C	+80 °C

Max short term base material temperature

Short-term elevated base material temperatures are those that occur over brief intervals, e.g. as a result of diurnal cycling.

Max long term base material temperature

Long-term elevated base material temperatures are roughly constant over significant periods of time.

Setting details

Anchor size	GD 14		
Drill hole diameter	d_o	[mm]	14
Cutting diameter of drill bit	$d_{cut} \leq$	[mm]	14,5
Depth of drilled hole to deepest point	$h_1 \geq$	[mm]	90
Overall plastic anchor embedment depth in base material	$h_{nom} \geq$	[mm]	70
Recommended length of screw in base material	l_d	[mm]	75

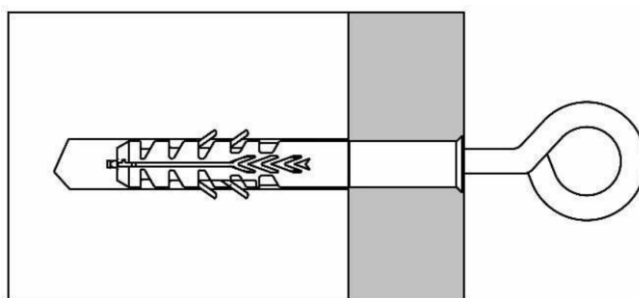

Installation equipment

Anchor size	GD 14
Rotary hammer	TE 2- TE16
Other tools	-

Setting instruction

*For detailed information on installation see instruction for use given with the package of the product.

Setting instruction for GD 14 + GRS 12

1. Drilling

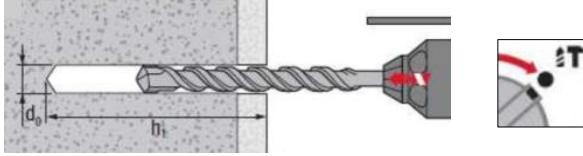

2. Cleaning



3. Inserting the anchor with hammer

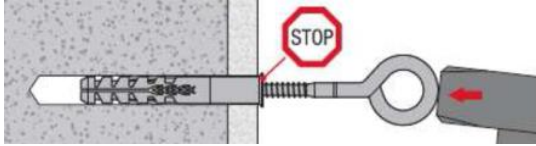

4. Inserting the anchor with hand

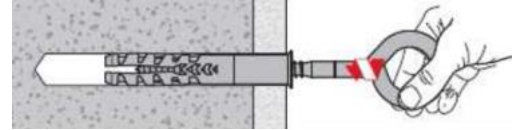

5. Checking

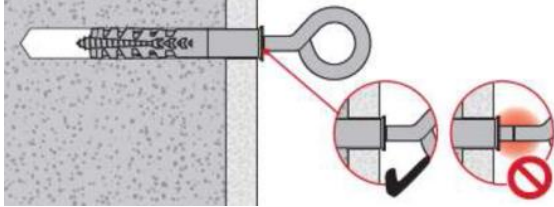

6. Loading the anchor

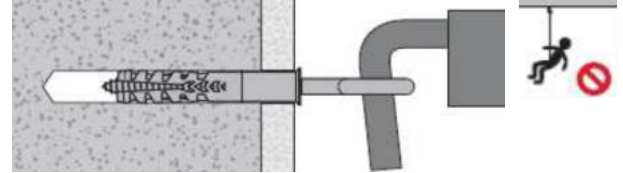

Use only for fixing scaffolds wall and floor applications. Not applicable for ceiling and façade applications.



Chemical anchors

Mechanical anchors

Plastic/Light duty metal anchors

Insulation anchors

DBZ Light duty metal anchors

Economical wedge anchor

Anchor version



DBZ
(M6)

Benefits

- Well proven
- Simple installation
- Small drill bit diameter
- Suitable for cracked and non-cracked concrete C20/25 to C50/60
- Redundant fastening only, e.g. suspended ceilings

Base material

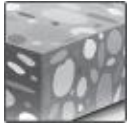

Concrete
(non-cracked)

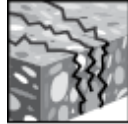

Concrete
(cracked)

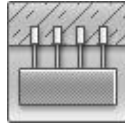

Redundant
fastening

Load conditions

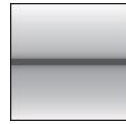

Static /
quasi-static



Fire
resistance

Other information



European
Technical
Assessment



CE conformity

Approvals / certificates

Description	Authority / Laboratory	No. / date of issue
European Technical Assessment ^{a)}	DIBt, Berlin	ETA-06/0179 / 2016-09-15
Fire test report	DIBt, Berlin	ETA-06/0179 / 2016-09-15
Assessment fire report	warringtonfire	WF364181 / 2016-05-03

a) All data given in this section according ETA-06/0179, issue 2016-09-15. The anchor is to be used only for redundant fastening for non-structural applications.

Basic loading data

All data in this section applies to:

- Correct setting (See setting instruction)
- No edge distance and spacing influence
- Concrete C20/25 to C50/60
- Anchors in redundant fastening

Characteristic resistance

Anchor size	DBZ 6 / 4,5	DBZ 6 / 35
Resistance, all load directions F_{Rk} [kN]	5,0	

Design resistance

Anchor size			DBZ 6 / 4,5	DBZ 6 / 35
Resistance, all load directions	F_{Rd}	[kN]	3,3	

Recommended loads ^{a)}

Anchor size			DBZ 6 / 4,5	DBZ 6 / 35
Resistance, all load directions	F_{Rec}	[kN]	2,4	

a) With overall partial safety factor for action $\gamma = 1,4$. The partial safety factors for action depend on the type of loading and shall be taken from national regulations.

The definition of redundant fastening according to Member States is given in the ETAG 001 Part six, Annex 1. In Absence of a definition by a Member States the following default values may be taken.

Minimum number of fixing points	Minimum number of anchors per fixing point	Maximum design load of action N_{sd} per fixing point ^{a)}
3	1	2
4	1	3

a) The value for maximum design load of actions per fastening point N_{sd} is valid in general that means all fastening points are considered in the design of the redundant structural system. The value N_{sd} may be increased if the failure of one (=most unfavourable) fixing point is taken into account in the design (serviceability and ultimate limit state) of the structural system e.g. suspended ceiling.

Materials

Mechanical properties

Anchor size			DBZ 6 / 4,5	DBZ 6 / 35
Nominal tensile strength	f_{uk}	[N/mm ²]	390	390
Yield strength	f_{yk}	[N/mm ²]	310	310
Stressed cross-section	A_s	[mm ²]	26	26
Char. bending resistance	$M^0_{Rk,s}$	[Nm]	5,0	5,0

Material quality

Part	Material
Anchor shank (1)	Cold-formed steel, galvanized $\geq 5\mu\text{m}$
Expansion pin (2)	Cold-formed steel, galvanized $\geq 5\mu\text{m}$

Anchor dimension

Anchor size			DBZ 6 / 4,5	DBZ 6 / 35
Height anchor head	l_1	[mm]	2,5	2,5
Max. distance	d_1	[mm]	6,4	6,4
Length of anchor shaft	l_2	[mm]	37,5	68

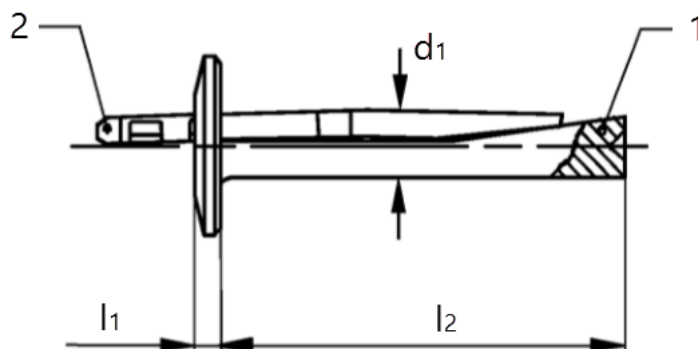

Setting information

Setting details

Anchor size		DBZ 6 / 4,5	DBZ 6 / 35	
Thickness of fixture	t_{fix} [mm]	$\leq 4,5$	$20 \leq t_{fix} \leq 35$	$5 \leq t_{fix} \leq 20$
Depth of drill hole	$h_1 \geq$ [mm]	40	55	70
Cutting diameter of drill bit	$d_{cut} \leq$ [mm]	6,4		
Nominal diameter of drill bit	d_0 [mm]	6		
Clearance hole diameter	$d_r \leq$ [mm]	7		

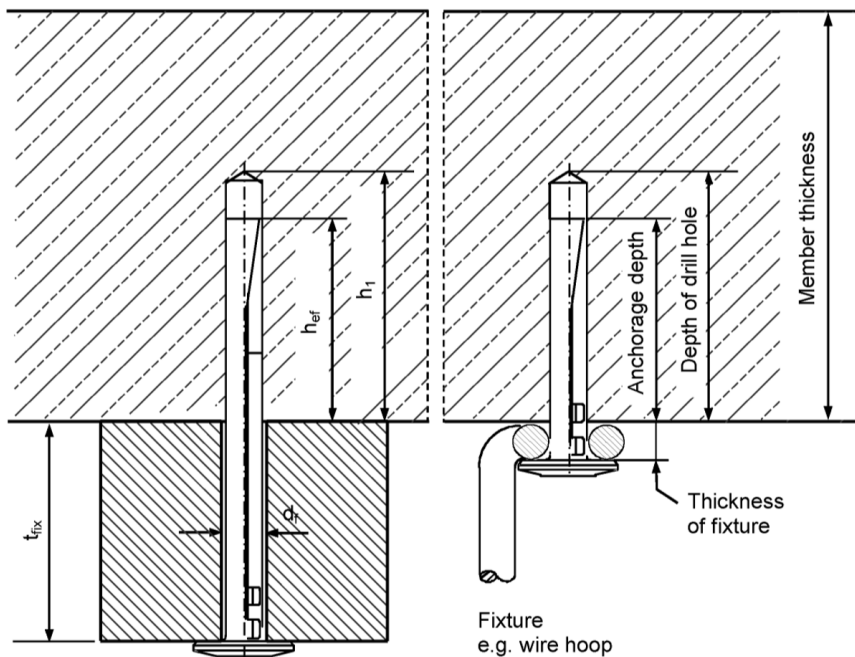

Installation equipment

Anchor size	DBZ 6 / 4,5	DBZ 6 / 35
Rotary hammer	TE 2 -TE 7	
Other tools	Hammer, blow out pump	

Setting parameters

Anchor size		DBZ 6 / 4,5	DBZ 6 / 35	
Thickness of fixture	t_{fix} [mm]	$\leq 4,5$	$20 \leq t_{fix} \leq 35$	$5 \leq t_{fix} \leq 20$
Minimum member thickness	$h_{min} \geq$ [mm]	80	100	
Effective anchorage length	$h_{ef} \geq$ [mm]	32		
Spacing	$s_{min} = s_{cr}$ [mm]	200		
Edge distance	$c_{min} = c_{cr}$ [mm]	150		

- a) The critical spacing (critical edge distance) shall be kept. Smaller spacing (edge distance) than critical spacing (critical edge distance) are not covered by the design method.

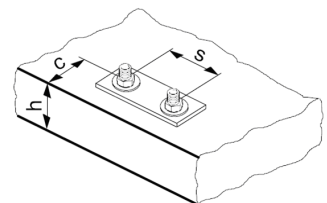

Setting instruction

*For detailed information on installation see instruction for use given with the package of the product.

Setting instructions		
<p>1 Drill hole with drill bit</p>	<p>2 Blow out dust completely</p>	<p>3 Insert anchor with fixture</p>
<p>4 Hammer down the expansion pin</p>	<p>5a Check if the pin is completely flattened</p>	<p>5b Max. exceedance of 2mm can be accepted</p>
<p>6 In case the pin exceedance is larger than 2mm replace the used drill bit with a new drill bit</p>		

HK Light duty metal anchors

Everyday standard ceiling anchor

Anchor version



HK
(M6-M8)



HK I
(M6-M8)



HK L
(M6-M8)

Benefits

- Well proven
- Small drill bit diameter
- For fixing in cracked concrete, redundant fastening only, e.g. suspended ceilings

Base material



Concrete
(non-cracked)



Tensile zone
(redundant
fastening)

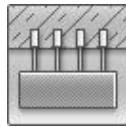

Redundant
fastening

Load conditions



Fire
resistance

Other information



European
Technical
Approval



CE
conformity

Approvals / certificates

Description	Authority / Laboratory	No. / date of issue
European technical assesment ^{a)}	DIBt, Berlin	ETA-04/0043, 2018-04-25
Fire test report	DIBt, Berlin	ETA-04/0043, 2018-04-25
Assessment fire report	warringtonfire	WF 327804/A / 2013-07-10

a) All data given in this section for HK Ceiling anchor according ETA-04/0043, issue 2018-04-25. The anchor is to be used only for multiple use for non-structural applications.

Basic loading data (for a single anchor)

All data in this section applies to:

- Correct setting (See setting instruction)
- No edge distance and spacing influence
- Concrete C20/25 to C50/60
- Non-cracked concrete: $f_{cc} \geq 20 \text{ N/mm}^2$
- Anchors in multiple use

Characteristic resistance

Anchor size (Carbon steel)	HK6	HK6 L	HK8 I
Resistance $F_{Rk}^{a)}$ [kN]	2,0	5,0	5,0
Anchor size (Stainless steel, HCR)	HK6 -R / -HCR	HK6 L -R / -HCR	HK8 I -R / -HCR
Resistance $F_{Rk}^{a)}$ [kN]	1,5	3,0	5,0

a) For all load directions (tension, shear and combined tension and shear loads)

Design resistance

Anchor size (Carbon steel)	HK6	HK6 L	HK8 I
Resistance $F_{Rd}^{a)}$ [kN]	1,3	2,4	2,4
Anchor size (Stainless steel, HCR)	HK6 -R / -HCR	HK6 L -R / -HCR	HK8 I -R / -HCR
Resistance $F_{Rd}^{a)}$ [kN]	0,7	1,4	2,8

a) For all load directions (tension, shear and combined tension and shear loads)

Recommended loads^{b)}

Anchor size (Carbon steel)	HK6	HK6 L	HK8 I
Resistance $F_{Rec}^{a)}$ [kN]	0,9	1,7	1,7
Anchor size (Stainless steel, HCR)	HK6 -R / -HCR	HK6 L -R / -HCR	HK8 I -R / -HCR
Resistance $F_{Rec}^{a)}$ [kN]	0,5	1,0	2,0

a) For all load directions (tension, shear and combined tension and shear loads)

b) With overall partial safety factor for action $\gamma = 1,4$. The partial safety factors for action depend on the type of loading and shall be taken from national regulations.

Special case: Groups of $n=2$ and /or $n=4$ anchors with small spacing:

The basic loading data for a single anchor is valid for one fixing point.

Fixing point can be:

- **Single anchors**
- **Groups of 2 anchors**
With $s_1 \geq 60\text{mm}$
- **Groups of 4 anchors**
With $s_1 \geq 100\text{mm}$ and $s_2 \geq 100$

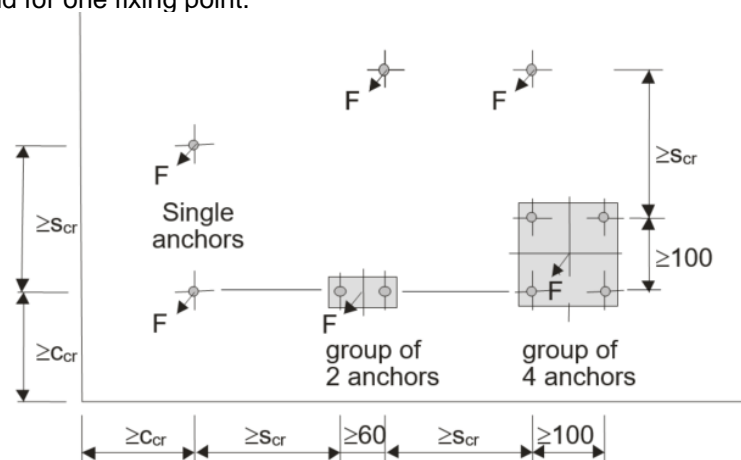

Requirements for multiple use

The definition of multiple use according to Member State is given in the ETAG 001 Part six, Annex 1. In absence of a definition by a Member State the following default values may be taken.

Minimum number of fixing points	Minimum number of anchors per fixing point	Maximum design load of action N_{Sd} per fixing point ^{a)}
3	1	2kN
4	1	3kN

a) The value for maximum design load of actions per fastening point N_{Sd} is valid in general that means all fastening points are considered in the design of the redundant structural system. The value N_{Sd} may be increased if the failure of one (=most unfavourable) fixing point is taken into account in the design (serviceability and ultimate limit state) of the structural system e.g. suspended ceiling.

Materials

Mechanical properties

Anchor size (carbon steel).o		HK6	HK6-L	HK8-I
Characteristic bending resistance	$M^0_{Rk,s}$ [Nm]	3,6	7,7	18
Anchor size (Stainless steel, HCR)		HK6 -R / -HCR	HK6 L -R / -HCR	HK8 I -R / -HCR
Characteristic bending resistance	$M^0_{Rk,s}$ [Nm]	4,0	8,4	20,6

Material quality

Part	Marking	Material
HK6 HK6 L HK8 I	K6 K6L K8	Galvanized steel $\geq 5\mu\text{m}$
HK6-R HK6 L-R HK8 I-R	K6E K6LE K8E	Stainless steel 1.4401 or 1.4404
	K6X K6LX K8X	Stainless steel 1.4571
HK6-HCR HK6 L-HCR HK8 I-HCR	K6C K6LC K8C	High corrosion resistant steel 1.4529 or 1.4565

Anchor dimension

Anchor size		HK6				
		HK6 M6/ t_{fix}		HK6 M8/ t_{fix}		
Thread size		External thread M6		External thread M8		
Setting tool		HSM 6/ t_{fix}		HSM 8/ t_{fix}		
Length of thread	l_{th} [mm]	$5 \leq l_{\text{th}} \leq 50$				
Max. thickness of fixture	t_{fix} [mm]	$t_{\text{fix}} = l_p - 7$				
Anchor size		HK6 L				
		HK M6/4 L	HK6 M6/ t_{fix} L	HK6 M8/ t_{fix} L	HK6-I M6 L	HK6-I M8 L
Thread size		External thread M6	External thread M6	External thread M8	Internal thread M6	Internal thread M6
Setting tool		HSM 6/4	HSM 6/ t_{fix}	HSM 8/ t_{fix}	HSM I M6	HSM I M8
Length of thread	l_{th} [mm]	≥ 5	≥ 5	≥ 5	-	-
Max. thickness of fixture	t_{fix} [mm]	4	$t_{\text{fix}} \leq 300$	$t_{\text{fix}} \leq 300$	-	-
Available thread length	[mm]	-	-	-	6 to 12	8 to 12
Anchor size		HK8 I				
		HK8 I M8	HK8 I M10	HK8 I M12	HK8 I M8/M10	
Thread size		Internal thread M8	Internal thread M10	Internal thread M12	Internal thread M8 / M10	
Setting tool		HSM 8 I M8	HSM 8 I M10	HSM 8 I M12	HSM 8 I M8	
Available thread length	[mm]	8 to 10	10 to 15	12 to 15	M8: 8 to 10 M10: 10	

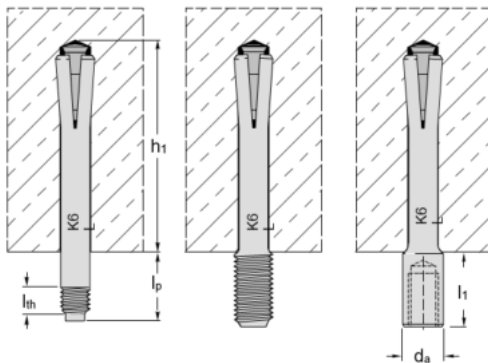

Setting

Setting details

Anchor size		HK6				
		HK6 M6/t _{fix}		HK6 M8/t _{fix}		
Depth of drill hole ^{a)}	h_1	32				
Nominal diameter of drill bit	d_0	6				
Clearance hole	$d_f \leq$	7		9		
Max. torque moment	T_{max}	5				
Anchor size		HK6 L				
		HK M6/4 L	HK6 M6/t _{fix} L	HK6 M8/t _{fix} L	HK6-I M6	HK6-I M8 L
Depth of drill hole ^{a)}	h_1	42				
Nominal diameter of drill bit	d_0	6				
Clearance hole	$d_f \leq$	7	7	9	9	12
Max. torque moment	T_{max}	5				
Anchor size		HK8 I				
		HK8 I M8	HK8 I M10	HK8 I M12	HK8 I M8/M10	
Depth of drill hole ^{a)}		43				
Setting tool		12	14	16	14	
Available thread length	[mm]	10				

a) Use stop drill bit to ensure correct depth of bore hole.

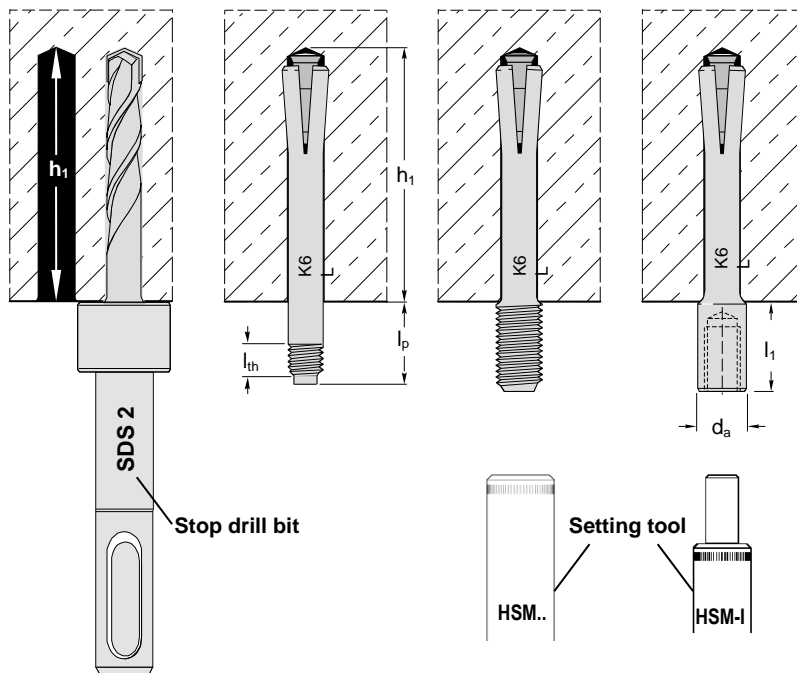

Installation equipment

Anchor size	HK6	HK6-L	HK8-I
Rotary hammer	TE 2 – TE 16		
Stop drill bit ^{a)}	TE-C/SDS 1	TE-C / SDS 2	TE – C/SDS 3
Setting tool	HSM ... / HSM I ...		HSM 8 .. /HSM 8 I..
Other tools	Blow out pump		

a) In case of through setting choose stop drill bit with appropriate length.

Setting parameters ^{a)}

Anchor size	HK6	HK6-L	HK8-I
Minimum member thickness $h_{min} \geq$ [mm]	80		
Effective anchorage depth h_{ef} [mm]	26	36	36
Critical spacing s_{cr} [mm]	200		
Critical edge distance c_{cr} [mm]	150		

a) The critical spacing (critical edge distance) shall be kept. Smaller spacing (edge distance) than critical spacing (critical edge distance) are not covered by the design method.

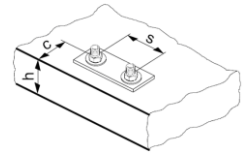

Setting instruction

*For detailed information on installation see instruction for use given with the package of the product.

Setting instruction	
External thread	
Setting of HK with hand setting tool 	Setting of HK with machine setting tool
Internal thread	
Setting of HK...-I with hand setting tool 	Setting of HK...-I with machine setting tool

HLC Light duty metal anchors







Economical sleeve anchor



Chemical anchors

Mechanical anchors

Plastic/Light duty metal anchors

Insulation anchors

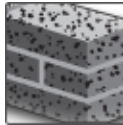
Anchor version			Benefits
	HLC (M5-M16)	Hex head nut with pressed-on washer	- Various head shapes and fastenings thickness
	HLC-H (M5-M16)	Bolt version with washer	
	HLC-L (M5-M16)	Torx round head	
	HLC-SK (M5-M16)	Torx counter sunk head	
	HLC-EC (M5-M16)	Loop-hanger head, eyebold closed	
	HLC-EO (M5-M16)	Loop-hanger head, eyebold open	
	HLC-T (M5-M16)	Ceiling hanger	

Base material	Load condition
 Concrete (non-cracked)	 Solid brick
	 Fire resistance

Approvals/certificates		
Description	Authority/Laboratory	No./date of issue
Fire test report	IBMB, Braunschweig	PB 3093/517/07-CM / 2007-09-10
Assessment report (fire)	Warringtonfire	WF 327804/A / 2013-07-10

Basic loading data (for a single anchor)

All data in this section is Hilti technical data and applies to:

- Correct setting (See setting instruction)
- No edge distance and spacing influence
- Concrete as specified in the table
- *Steel* failure
- Minimum base material thickness
- Concrete C 20/25, $f_{ck,cube} = 25 \text{ N/mm}^2$

Effective anchorage depth

Anchor size	M5	M6	M8	M10	M12	M16
Effective anchorage depth h_{ef} [mm]	16	26	31	33	41	41

Characteristic resistance

Anchor size	M5	M6	M8	M10	M12	M16
Tension N_{Rk} [kN]	2,1	3,5	4,5	7,2	10,0	13,2
Shear V_{Rk} [kN]	3,2	7,0	8,8	14,4	20,0	20,0

Design resistance

Anchor size	M5	M6	M8	M10	M12	M16
Tension N_{Rd} [kN]	1,2	2,0	2,5	4,0	5,6	7,4
Shear V_{Rd} [kN]	1,8	3,9	4,9	8,0	11,1	11,1

Recommended loads^{a)}

Anchor size	M5	M6	M8	M10	M12	M16
Tension N_{Rec} [kN]	0,8	1,4	1,8	2,9	4,0	5,3
Shear V_{Rec} [kN]	1,3	2,8	3,5	5,7	7,9	7,9

a) With overall partial safety factor for action $\gamma = 1,4$. The partial safety factors for action depend on the type of loading and shall be taken from national regulations.

Materials

Material quality

Part	Material
Anchor HLC HLC-EC HLC-EO	Carbon steel tensile strength 500 MPa galvanized to min. 5 μm
Anchor HLC-H HLC-L HLC-SK HLC-T	Steel Bolt Strength 8.8, galvanized to min 5 μm

Anchor dimensions

Anchor version	Thread size	h_{ef} [mm]	d [mm]	l [mm]	l_c [mm]	t_{fix} [mm]	
HLC, HLC-H, HLC-EC/EO carbon steel anchors	6,5 x 25/5	16	M5	30	25	5	
	6,5 x 40/20			45	40	20	
	6,5 x 60/40			65	60	40	
	8 x 40/10	26	M6	46	40	10	
	8 x 55/25			61	55	20	
	8 x 70/40			76	70	40	
	8 x 85/55			91	85	55	
	10 x 40/5	31	M8	48	40	5	
	10 x 50/15			58	50	15	
	10 x 60/25			68	60	25	
	10 x 80/45			88	80	45	
	10 x 100/65	33	M10	108	100	65	
	12 x 55/15			65	55	15	
	12 x 75/35			85	75	35	
	12 x 100/60	41	M12	110	100	60	
	16 x 60/10			72	60	10	
	16 x 100/50			112	100	60	
	16 x 140/90	41	M16	152	140	95	
	20 x 80/25			95	80	25	
	20 x 115/60			130	115	60	
20 x 150/95	41	M16	165	150	95		
6,5 x 45/20			16	M5	45	-	20
6,5 x 65/40					65		40
6,5 x 85/60	85	60					
HLC-SK carbon steel anchors	8 x 60/25	26	M6	60	-	25	
	8 x 75/40			75		40	
	8 x 90/55			90		55	
	10 x 45/5	31	M8	45	-	5	
	10 x 85/45			85		45	
	10 x 105/65			105		65	
	10 x 130/95			130		95	
	12 x 55/15	33	M10	80	-	35	

HLC, HLC-H, HLC-EC/EO, HLC-L

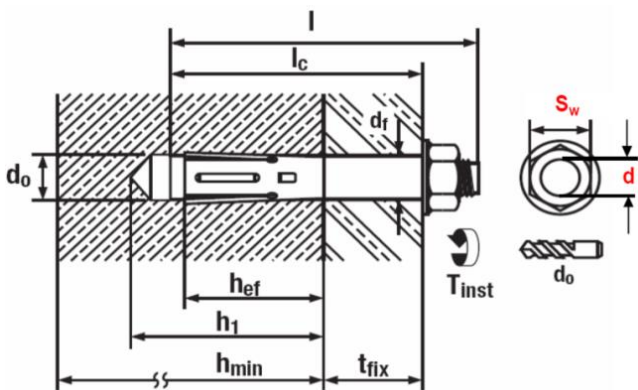

HLC-SK

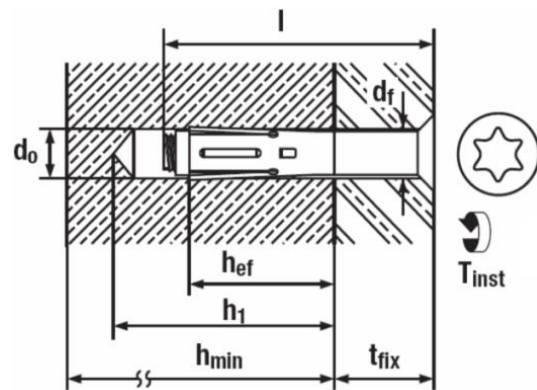

Setting information

Setting details HLC

		M5	M6	M8	M10	M12	M16
Nominal diameter of drill bit	d_0 [mm]	6,5	8	10	12	16	20
Cutting diameter of drill bit	$d_{cut} \leq$ [mm]	6,4	8,45	10,45	12,5	16,5	20,55
Depth of drill hole	$h_1 \geq$ [mm]	30	40	50	65	75	85
Width across nut flats	HLC SW [mm]	8	10	13	15	19	24
	HLC-H SW [mm]				17		
	HLS-SK Driver	PZ 3	T 30	T 40	T 40	-	-
Diameter of clearance hole in the fixture	$d_f \leq$ [mm]	7	10	12	14	18	21
Effective anchorage depth	h_{ef} [mm]	16	26	31	33	41	41
Max. torque moment concrete	T_{inst} [Nm]	5	8	25	40	50	80
Max. torque moment masonry	T_{inst} [Nm]	2,5	4	13	20	25	-

Installation equipment

Anchor size	M5	M6	M8	M10	M12
Rotary hammer for setting	TE 2 – TE 16				
Other tools	hammer, torque wrench, blow up pump				

Setting parameters

Anchor size	M6	M8	M10	M10	M12	M16	
Minimum base material thickness	h_{min} [mm]	60	70	80	100	100	120
Critical spacing for splitting failure and concrete cone failure	s_{cr} [mm]	60	100	120	130	160	160
Critical edge distance for splitting failure and concrete cone failure	c_{cr} [mm]	30	50	60	65	80	80

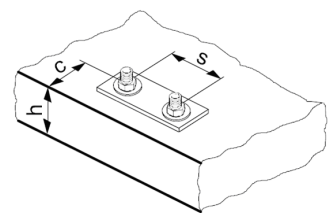

Setting instruction

*For detailed information on installation see instruction for use given with the package of the product.

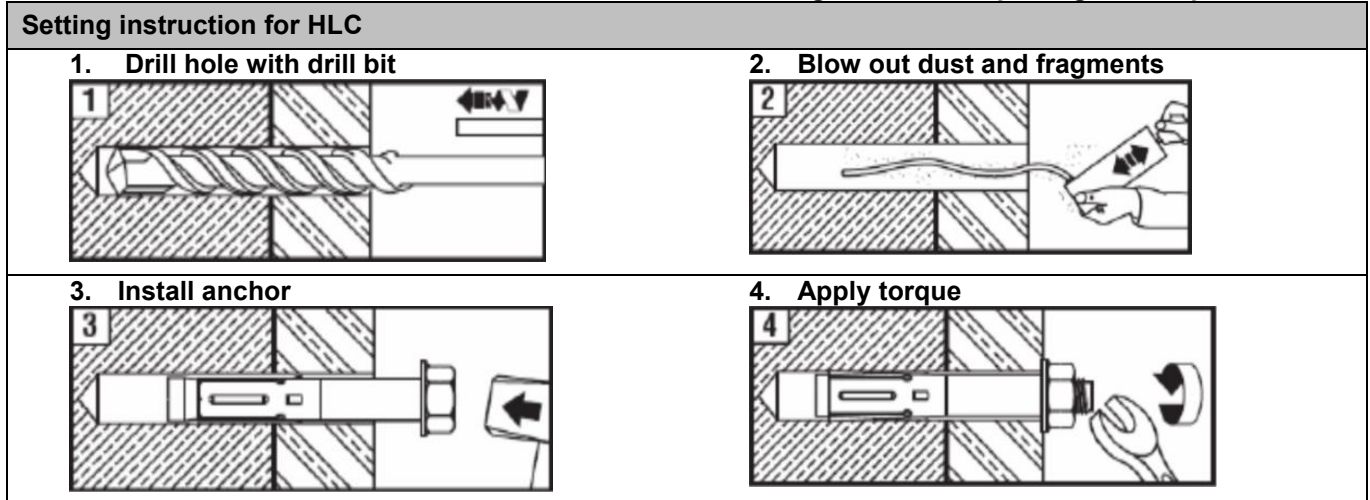

Basic loading data (for a single anchor) in solid masonry units



All data in this section applies to

- Load values valid for holes drilled with TE rotary hammers in hammering mode
- Correct anchor setting (see instruction for use, setting details)
- The core / material ratio may not exceed 15% of a bed joint area.
- The brim area around holes must be at least 70mm
- Edge distances, spacing and other influences, see below

Anchorage depth

Anchor size		M5	M6	M8	M10	M12
Nominal anchorage depth	h_{nom} [mm]	16	26	31	33	41

Recommended loads^{a)}

Anchor size		M5	M6	M8	M10	M12	
Solid clay brick Mz12/2,0 (Germany, Austria, Switzerland)							
	DIN 105/ EN 771-1 $f_b^{b)} \geq 12 \text{ N/mm}^2$	Tension $N_{Rec}^{c)}$ [kN]	0,3	0,5	0,6	0,7	0,8
		Shear $V_{Rec}^{c)}$ [kN]	0,45	1,0	1,2	1,4	1,6
Solid clay brick Mz12/2,0 (Germany, Austria, Switzerland)							
	DIN 106/ EN 771-2 $f_b^{b)} \geq 12 \text{ N/mm}^2$	Tension $N_{Rec}^{d)}$ [kN]	0,4	0,5	0,6	0,8	0,8
		Shear $V_{Rec}^{d)}$ [kN]	0,65	1,0	1,2	1,6	1,6

a) Recommended load values for German base materials are based on national regulations.

b) f_b =brick strength

c) Values only valid for Mz(DIN 105) with brick strength $\geq 19 \text{ N/mm}^2$, density $2,0 \text{ kg/dm}^3$, min. brick size NF (24,0 cm x 11,5 cm x 11,5 cm)

d) Values only valid for KS(DIN 106) with brick strength $\geq 29 \text{ N/mm}^2$, density $2,0 \text{ kg/dm}^3$, min. brick size NF (24,0 cm x 11,5 cm x 11,5 cm)

Permissible anchor location in brick and block walls

Anchor position in Brick

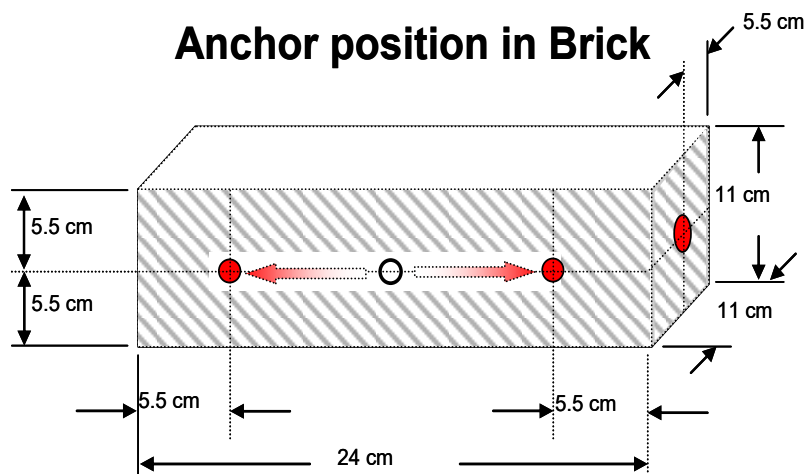

Edge distance and spacing influences

- The technical data for the HLC sleeve anchors are reference loads for MZ 12 and KS 12. Due to the large variation of natural stone solid bricks, on site anchor testing is recommended to validate technical data.
- The HLC anchor was installed and tested in center of solid bricks as shown. The HLC anchor was not tested in the mortar joint between solid bricks or in hollow bricks, however a load reduction is expected.
- For brick walls where anchor position in brick cannot be determined, 100% anchor testing is recommended.
- Distance to free edge free edge to solid masonry (Mz and KS) units ≥ 300 mm
- The minimum distance to horizontal and vertical mortar joint (c_{min}) is stated in the drawing above.
- Minimum anchor spacing (s_{min}) in one brick/block is $\geq 2 \cdot c_{min}$

Limits

- Applied load to individual bricks may not exceed 1,0 kN without compression or 1,4 kN with compression
- All data is for multiple use for non-structural applications

Plaster, graveling, lining or levelling courses are regarded as non-bearing and may not be taken into account for the calculation of embedment depth.

HT Light duty metal anchors

Economical metal frame anchor

Anchor version



HT
(M8-M10)

Benefits

- Fastening door and window frames
- No risk of distortion or forces of constraint
- Expansion cone cannot be lost

Base material



Concrete
(non-cracked)

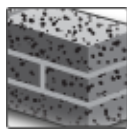

Solid brick

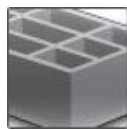

Hollow brick



Autoclaved
aerated
concrete

Load conditions



Fire
resistance

Approvals / certificates

Description	Authority / Laboratory	No. / date of issue
Fire test report	IBMB, Braunschweig	UB 3016/1114-CM / 2006-03-13
Assessment report (fire)	warringtonfire	WF 327804/A / 2013-07-10

Basic loading data (for a single anchor)

All data in this section applies to:

- Correct setting (See setting instruction)
- No edge distance and spacing influence
- Base material as specified in the table
- Non-cracked concrete: $f_{cc} \geq 20 \text{ N/mm}^2$
- Minimum base material thickness

Characteristic resistance

Anchor size		HT 8	HT 10
Concrete, $f_{cc}=30 \text{ N/mm}^2$	N_{Rk} [kN]	4,2	5,0
	V_{Rk} [kN]	6,6	7,0
Aerated concrete PP2 ^{a)}	N_{Rk} [kN]	-	0,3
	V_{Rk} [kN]	-	0,5
Solid brick Mz 12	N_{Rk} [kN]	1,8	2,6
	V_{Rk} [kN]	-	5,0
Sand-lime solid brick, KS 12	N_{Rk} [kN]	1,8	2,6
	V_{Rk} [kN]	-	5,0
Sand-lime hollow brick, KSL	N_{Rk} [kN]	-	1,5
	V_{Rk} [kN]	-	0,5

a) Rotary drilling only.

Recommended loads

Anchor size		HT 8	HT 10
Concrete, $f_{cc}=30 \text{ N/mm}^2$	N_{Rec} [kN]	1,4	1,7
	V_{Rec} [kN]	0,5	0,5
Aerated concrete PP2 ^{a)}	N_{Rec} [kN]	-	0,1
	V_{Rec} [kN]	-	0,15
Solid brick Mz 12	N_{Rec} [kN]	0,6	0,8
	V_{Rec} [kN]	-	0,5
Sand-lime solid brick, KS 12	N_{Rec} [kN]	0,6	0,8
	V_{Rec} [kN]	-	0,5
Sand-lime hollow brick, KSL	N_{Rec} [kN]	-	0,5
	V_{Rec} [kN]	-	0,15

a) Rotary drilling only.

Materials

Material quality

Part	Material
Bolt	Steel strength 4.8, zinc plated to 5 μm
Sleeve	Steel 02 DIN 17162, sendzimir zinc plated to 20 μm

Setting information

Setting details

Anchor size		HT 8	8x72	8x92	8x112	8x132	8x152	8x182
Nominal diameter of drill bit	d_0 [mm]	8	8	8	8	8	8	8
Depth of drill hole	h_1 [mm]	50	50	50	50	50	50	50
Anchorage depth	h_{nom} [mm]	30	30	30	30	30	30	30
Anchor length	L [mm]	72	92	112	132	152	182	
Torque moment	$T_{inst}^{a)}$ [Nm]	100	100	100	100	100	100	100
Minimum base material thickness	h_{min} [mm]	4	4	4	4	4	4	4
Drill bit		TE-CX-8/17		TE-CX-8/22		TE-CX-8/27		

Setting details

Anchor size		HT 10	10x72	10x92	10x112	10x132	10x152	10x182	10x202
Nominal diameter of drill bit	d_0 [mm]	10	10	10	10	10	10	10	10
Depth of drill hole	h_1 [mm]	50	50	50	50	50	50	50	50
Anchorage depth	h_{nom} [mm]	30	30	30	30	30	30	30	30
Anchor length	L [mm]	72	92	112	132	152	182	202	
Torque moment	$T_{inst}^{a)}$ [Nm]	100	100	100	10	10	10	10	10
Minimum base material thickness	h_{min} [mm]	8/4	8/4	8/4	8/4	8/4	8/4	8/4	8/4
Drill bit		TE-C-10/17		TE-C-10/22		TE-C-10/27		TE-C-10/37	

a) First value: solid base material, second value: hollow base material.

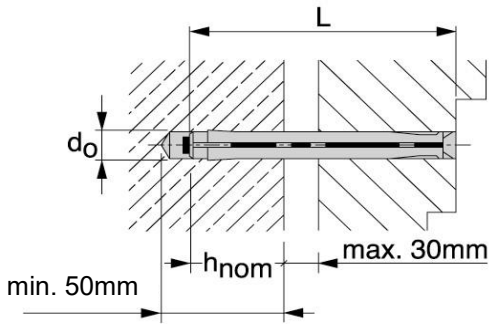

Installation equipment

Anchor size	HT 8	HT 10
Rotary hammer	TE1-TE16	
Other tools	hammer, screwdriver	

Setting instruction

*For detailed information on installation see instruction for use given with the package of the product.

Setting instruction		
1. Drill hole with the drill bit 	2. Install anchor 	3. Drive screw into anchor

HLV Light duty anchors

Economical sleeve anchor

Anchor version



HLV
Pre-setting
(M5-M12)



HLV
Through fastening
(M6-M12)

Benefits

- Available in a variety of sizes in both pre-setting and through fastening configurations
- Carbon steel grade 4.8, zinc galvanized to min 5µm

Base material



Concrete
(non-cracked)

Static resistance

All data in this section is Hilti technical data and applies to:

- Correct setting (See setting instruction)
- No edge distance and spacing influence
- Minimum base material thickness
- Concrete C 20/25, $f_{ck,cube} = 25 \text{ N/mm}^2 - 60 \text{ n/mm}^2$

Characteristic resistance

Anchor size		Pre-setting						Through fastening			
		6,5x22/7	8x35/4	10x45/10	12x48/10	12x60/17	16x68/20	8x35/10	10x75/45	12x95/60	16x130/90
Tension N_{Rk}	[kN]	5,2	7,1	13,0	15,9	21,9	28,3	5,6	8,3	10,5	12,8
Shear V_{Rk}	[kN]	3,3	5,6	11,4	13,0	13,0	19,7	5,6	8,3	10,5	12,8

Design resistance

Anchor size		Pre-setting						Through fastening			
		6,5x22/7	8x35/4	10x45/10	12x48/10	12x60/17	16x68/20	8x35/10	10x75/45	12x95/60	16x130/90
Tension N_{Rd}	[kN]	2,5	3,4	6,1	7,5	10,4	13,5	2,7	4,0	5,0	6,1
Shear V_{Rd}	[kN]	1,5	2,6	5,4	6,1	6,1	9,4	2,7	4,0	5,0	6,1

Recommended loads^{a)}

Anchor size		Pre-setting						Through fastening			
		6,5x22/7	8x35/4	10x45/10	12x48/10	12x60/17	16x68/20	8x35/10	10x75/45	12x95/60	16x130/90
Tension N_{Rec}	[kN]	1,7	2,4	4,3	5,3	7,4	9,6	1,9	2,8	3,6	4,3
Shear V_{Rec}	[kN]	1,0	1,8	3,8	4,3	4,3	6,7	1,9	2,8	3,6	4,3

a) With overall partial safety factor for action $\gamma = 1,4$. The partial safety factors for action depend on the type of loading and shall be taken from national regulations.

Materials

Material quality

Part	Material
Anchor body	Carbon steel, $f_{uk} \geq 400 \text{ N/mm}^2$ galvanised to min. 5 μm

Anchor dimensions

Anchor size		Pre-setting						Through fastening			
		6,5x22/7	8x35/4	10x45/10	12x48/10	12x60/17	16x68/20	8x35/10	10x75/45	12x95/60	16x130/90
Thread size	d [-]	M5	M6	M8	M10	M12	M6	M8	M10	M12	
Anchor diameter	d_1 [mm]	6,5	8	10	12	16	8	10	12	16	
Length of anchor bolt	l [mm]	39	51	68	76	95	109	47	88	114	152
Length of sleeve	l_s [mm]	22	35	45	48	60	68	35	75	95	130

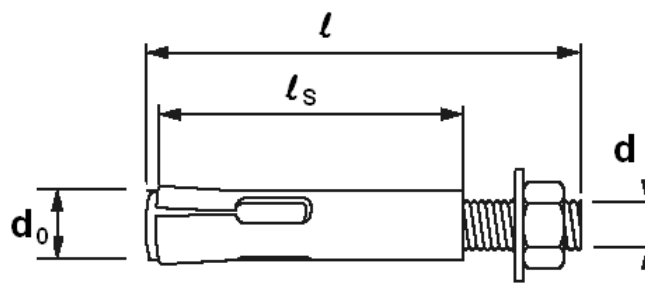

Setting information

Setting details HLV

Anchor size	Pre-setting						Through fastening			
	6,5x22/7	8x35/4	10x45/10	12x48/10	12x60/17	16x68/20	8x35/10	10x75/45	12x95/60	16x130/90
Thread size	M5	M6	M8	M10		M12	M6	M8	M10	M12
Thickness of fixture $t_{fix} \leq$ [mm]	7	4	10	10	17	20	10	45	60	90
Nominal diameter of drill bit d_o [mm]	6,5 (1/4")	8	10	12		16	8	10	12	16
Cutting diameter of drill bit $d_{cut} \leq$ [mm]	6,4	8,45	10,45	12,5		16,5	8,45	10,45	12,5	16,5
Depth of drill hole $h_1 \geq$ [mm]	40	50	65	70	80	100	40	50	55	70
Width across nut flats SW [mm]	8	10	13	17		19	10	13	17	19
Diameter of clearance hole in the fixture $d_f \leq$ [mm]	6	7	9	11	11	14	10	12	14	18
Effective anchorage depth h_{ef} [mm]	22	35	45	48	60	68	25	30	35	40
Max. torque moment T_{inst} [Nm]	2	4	25	40		50	4	25	40	50

Installation equipment

Anchor size	6,5	8	10	M12	M16
Rotary hammer for setting	TE 2 – TE 16				
Other tools	hammer, torque wrench, blow up pump				

Setting parameters

Anchor size	Pre-setting						Through fastening			
	6,5x22/7	8x35/4	10x45/10	12x48/10	12x60/17	16x68/20	8x35/10	10x75/45	12x95/60	16x130/90
Minimum base material $h_{min} \geq$ [kN]	80	80	90	100	120	140	80 ^{a)}	80 ^{a)}	80 ^{a)}	80 ^{a)}
Minimum spacing $s_{min} \geq$ [mm]	200	200	200	200	240	280	200	200	200	200
Minimum edge distance $c_{min} \geq$ [mm]	100	105	135	150	180	210	100	100	105	120

a) In case of deeper embedment than h_{ef} , $h_{min} \geq 2x$ embedment depth.

Setting instruction

*For detailed information on installation see instruction for use given with the package of the product.

Setting instruction	
Pre-setting	
<p>1.</p>	<p>2. Drilling</p>
<p>3. Cleaning</p>	<p>4. Inserting the anchor</p>
<p>5. Inserting the anchor by hammer</p>	<p>6. Attaching the belonging washer</p>
Through fastening	
<p>1.</p>	<p>2. Drilling</p>
<p>3. Cleaning</p>	<p>4. Inserting the anchor by hammer</p>
<p>5. Attaching the belonging washer</p>	

HAM Light duty metal anchors

Economical sleeve anchor

Anchor version



HAM
8.8 screw
(M6-M12)



HAM
(M6-M12)

Benefits

- Secure fastenings in various base materials
- Cone attached to sleeve to ensure pre-setting
- Wings to prevent spinning in the borehole
- Plastic cap in cone to prevent dust entrance
- Blue-chromate zinc coating
- 8.8 steel strength of screw

Base material



Concrete
(non-cracked)

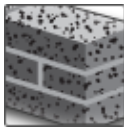

Solid brick

Basic loading data (for a single anchor)

All data in this section applies to:

- Correct setting (See setting instruction)
- No edge distance and spacing influence
- Concrete as specified in the table
- *Steel* failure
- Minimum base material thickness
- Concrete C 20/25, $f_{ck,cube} = 25 \text{ N/mm}^2$

Recommended loads in non-cracked concrete C20/25

Thread diameter		M6x50	M8x60	M10x80	M12x90
Tension N_{Rec}	[kN]	4,0	4,8	5,8	8,7
Shear V_{Rec}	[kN]	4,6	8,4	13,3	19,3

Recommended loads in solid bricks

Thread diameter		M6x50	M8x60	M10x80	M12x90
Tension N_{Rec}	[kN]	For solid brick, load values need to be determined on the building site			
Shear V_{Rec}	[kN]				

Materials

Material quality

Part	Material
Sleeve	Carbon steel
HAM Anchor Hex head Bolt	Carbon steel DIN 933, Strength 8.8
Washer	Carbon steel, DIN 9021

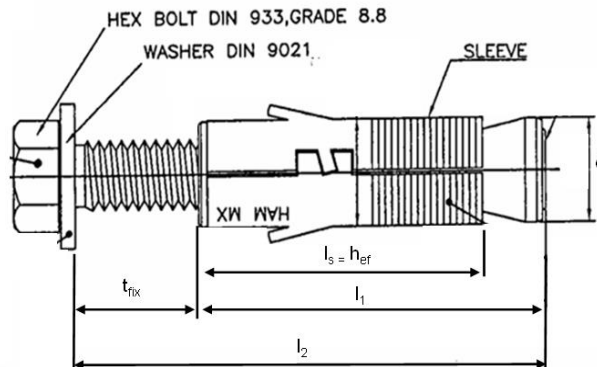

Anchor dimension of HAM

Anchor size		M6x50	M8x60	M10x80	M12x90
Effective anchorage depth	h_{ef} [mm]	30	35	43	55
Anchor diameter	d [mm]	12	14	16	19
Effective anchorage length	$l_s = h_{ef}$ [mm]	30	35	43	55
Length of expansion sleeve	l_1 [mm]	40	50	60	70
Length of anchor	l_2 [mm]	50	60	80	90
Thickness of the fixture	t_{fix} [mm]	10	10	20	20

Setting

Setting details of HAM

Anchor size		M6x50	M8x60	M10x80	M12x90
Nominal diameter of drill bit	d_0 [mm]	12	14	16	20
Cutting diameter of drill bit	$d_{cut} \leq$ [mm]	12,5	14,5	16,5	20,55
Depth of drill hole	$h_1 \geq$ [mm]	65	80	90	110
Width across nut flats	SW [mm]	10	13	17	19
Diameter of clearance hole in the fixture	$d_f \leq$ [mm]	7	9	12	14
Max. torque moment concrete	T_{inst} [Nm]	10	25	45	75
Max. torque moment masonry	T_{inst} [Nm]	5	10	20	30

Installation equipment

Anchor size		M6x50	M8x60	M10x80	M12x90
Rotary hammer for setting		TE 2 – TE 16			
Drill bit	TE-C3X	12	14	16	20
Other tools		hammer, torque wrench, blow up pump			

HPD Light duty metal anchors

Aerated concrete anchor

Anchor version



HPD

Benefits

- Anchor for autoclaved aerated concrete
- Maximum use of base material capacity
- Setting without drilling

Base material



Autoclaved aerated concrete

Load conditions



Fire resistance

Other information



Sprinkler approved

Approvals / certificates

Description	Authority / Laboratory	No. / date of issue
Allgemeine bauaufsichtliche Zulassung (national approval in Germany) ^{a)}	DIBt, Berlin	Z-21.1-1729 / 2011-05-31
Fire test report	IBMB, Braunschweig	UB 3077/3602-Nau- / 2002-02-05
Assessment report (fire)	warringtonfire	WF 327804/A / 2013-07-10
Sprinkler	VdS, Cologne	G 4981083 / 2008-01-01

Basic loading data

All data in this section applies to:

- Correct setting (See setting instruction)
- No edge distance and spacing influence
- Autoclaved aerated concrete (AAC)
- Load data given in the tables is independent of load direction
- Minimum base material thickness

Recommended loads for a single anchor

Anchor size		M6	M8	M10
Non-cracked AAC^{a)}				
AAC blocks	AAC 2 [kN]	0,4	0,4	0,6
	AAC 4, AAC 6 [kN]	0,8	0,8	1,2
AAC wall members	P 3,3 [kN]	0,6	0,6	0,8
	P 4,4 [kN]	0,8	0,8	1,2
Cracked AAC				
AAC ceiling members	P 3,3 [kN]	0,6	0,6	0,8
	P 4,4 [kN]	0,8	0,8	1,2

^{a)} In case of small sized AAC blocks (<= 250mm x 500mm x thickness) the recommended load has to be reduced with a factor 0,6.

Recommended loads for a group of two anchor with a spacing $100\text{mm} \leq s \leq 200\text{mm}$

Anchor size		M6	M8	M10	
Non-cracked AAC^{a)}					
AAC blocks	AAC 2	[kN]	0,4	0,4	0,6
	AAC 4, AAC 6	[kN]	0,8	0,8	1,2
AAC wall members	P 3,3	[kN]	0,6	0,6	0,8
	P 4,4	[kN]	0,8	0,8	1,2
Cracked AAC					
AAC ceiling members	P 3,3	[kN]	0,6	0,6	0,8
	P 4,4	[kN]	0,8	0,8	1,2

a) In case of small sized AAC blocks ($\leq 250\text{mm} \times 500\text{mm} \times \text{thickness}$) the recommended load has to be reduced with a factor 0,6.

Recommended loads for a group of two anchor with a spacing $s \geq 200\text{mm}$

Anchor size		M6	M8	M10	
Non-cracked AAC^{a)}					
AAC blocks	AAC 2	[kN]	0,6	0,6	0,8
	AAC 4, AAC 6	[kN]	1,1	1,1	1,7
AAC wall members	P 3,3	[kN]	0,8	0,8	1,1
	P 4,4	[kN]	1,1	1,1	1,7
Cracked AAC					
AAC ceiling members	P 3,3	[kN]	0,8	0,8	1,1
	P 4,4	[kN]	1,1	1,1	1,7

a) In case of small sized AAC blocks ($\leq 250\text{mm} \times 500\text{mm} \times \text{thickness}$) the recommended load has to be reduced with a factor 0,6.

Materials
Mechanical properties

Anchor size		M6	M8	M10	
Nominal tensile strength	f_{uk}	Carbon steel	800	500	500
		Stainless steel	750	565	565
Yield strength	f_{yk}	Carbon steel	-	-	-
		Stainless steel	-	-	-
Stressed cross-section	A_s	[mm ²]	20,1	36,6	58
Moment of resistance	W	[mm ³]	12,7	31,2	62,3
Char. bending resistance for rod or bolt	$M^0_{Rk,s}$	Carbon steel	12	19	37
		Stainless steel	11	21	42

The recommended bending moment shall be calculated by dividing the characteristic bending moment by 1,4 and 1,25.

Material quality

Part	Material	
All parts	HPD	Carbon steel, galvanised to min. 5 μm
	HPD (stainless steel)	Stainless steel

Anchor dimension

Anchor size		M6	M8	M10	
Minimum thickness of fixture	$t_{fix,min}$	[mm]	0	0	0
Maximum thickness of fixture*	$t_{fix,max}$	[mm]	30	20	30
Anchor diameter	d_1	[mm]	9,8	11,8	13,8
Length of the expansion sleeve	l_c	[mm]	70		
Length of the cone	l_d	[mm]	12		

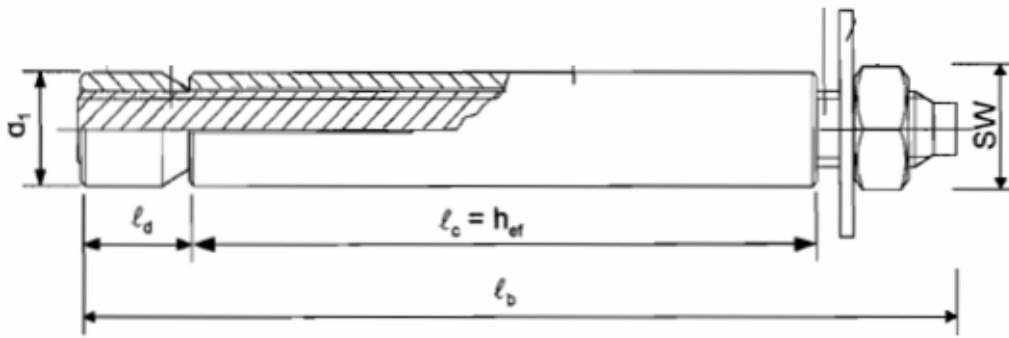

Setting information

Setting details

Anchor size			M6	M8	M10
Diameter of clearance hole in the fixture	$d_f \leq$	[mm]	7	9	12
Effective anchorage depth	h_{ef}	[mm]	62	62	62
Torque moment	T_{inst}	[Nm]	3	5	8
Width across	SW	[mm]	10	13	17

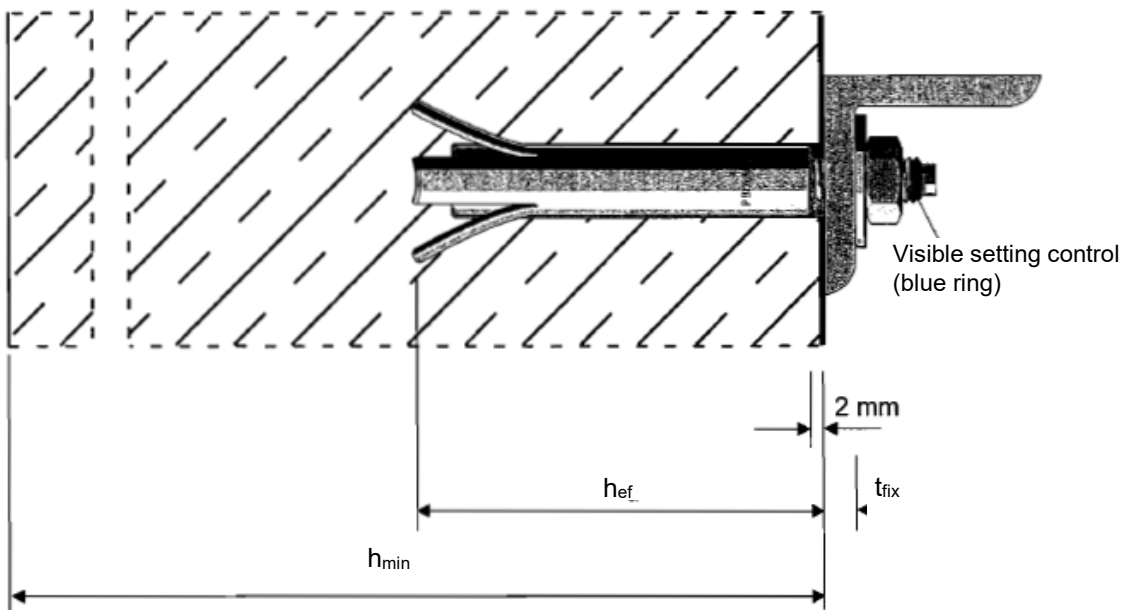

Installation equipment

Anchor size		M6/10	M6/30	M8/10	M8/20	M10/10	M10/30
Setting tool	Manual setting tool (to be used with a hammer)	HPE-G 6/10	HPE-G 6/30	HPE-G 8/10	HPE-G 8/20	-	-
	Machine setting (to be used with a rotary hammer in pure hammering mode)	-	-	-	-	HPE-M 10/10	HPE-M 10/30

Setting parameters

Anchor size			M6	M8	M10
Minimum base material thickness	h_{min}	[mm]	175		
Min. spacing	Of anchors in a group	$s_{min,anchor}$	100 / 200		
	Of anchor groups	$s_{min,group}$	600		
Min. edge distance	to member edge and to vertical joints	$c_{min,1}$	150	150	150
	to horizontal joints	$c_{min,2}$	50	50	50

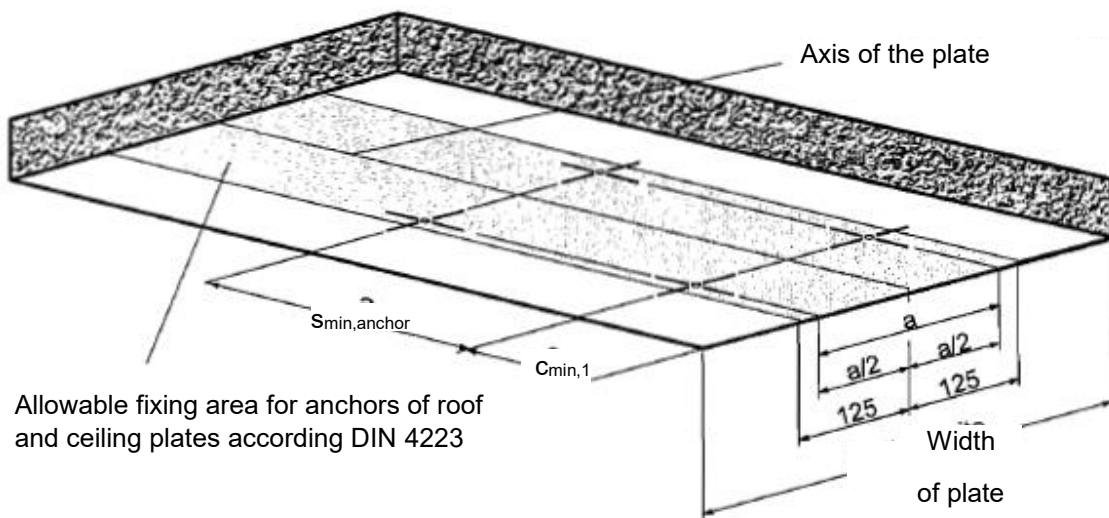
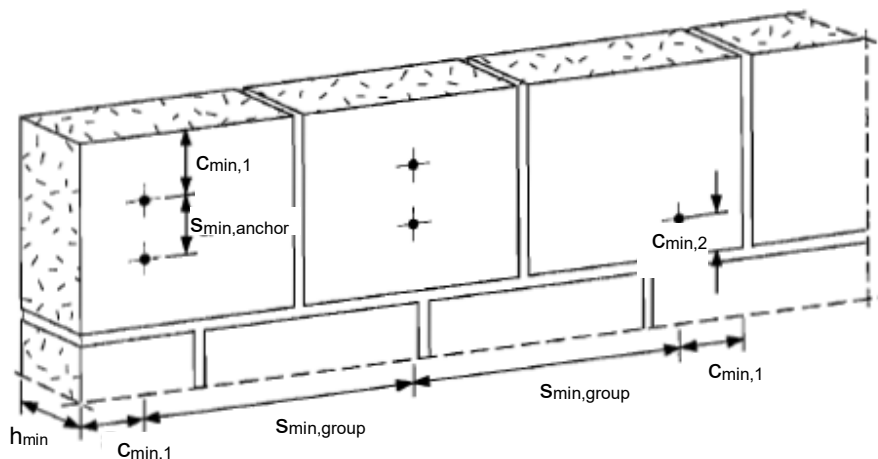

Allowable fixing area for anchors of roof and ceiling plates according DIN 4223

Setting instruction

*For detailed information on installation see instruction for use given with the package of the product.

Setting instruction

1. Insert the cone bolt by hammering it in, until setting tool touches surface.



2. Insert the expansion sleeve over the threaded rod.

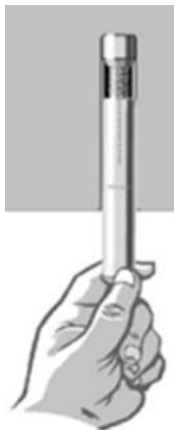

3. Drive in the sleeve by hammering or with the machine setting tool.

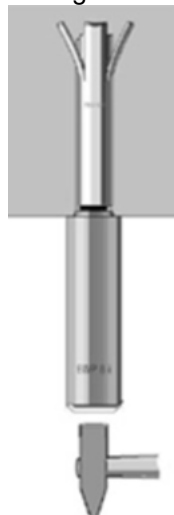

4. Tighten the nut until the blue ring becomes visible.

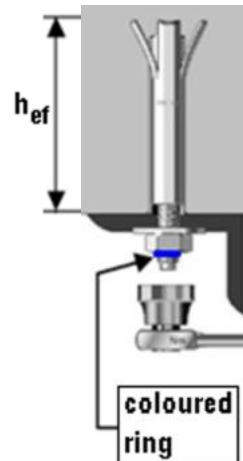

HKH Light duty metal anchors

Hollow deck anchor

Anchor version



HKH
(M6-M10)

Benefits

- Anchor for suspended ceilings and overhead support applications
- Channel installation
- Optical setting control

Base material



Prestressed hollow core slabs

Load condition



Fire resistance



Corrosion resistance

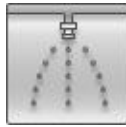

Sprinkler approved

Approvals / certificates

Description	Authority / Laboratory	No. / date of issue
Allgemeine bauaufsichtliche Zulassung (national approval in Germany for a single point fastening) ^{a)}	DIBt, Berlin	Z-21.1-1722 / 2011-10-31
Fire test report	IBMB, Braunschweig	UB 3606 / 8892 / 2002-07-22
Assessment report (fire)	warringtonfire	WF 327804/A / 2013-07-10
Sprinkler	VdS, Cologne	G 4961028 / 2006-09-05

^{a)} All data given in this section according DIBt Z-21.1-1722, issue 2011-10-31.

Basic loading data

All data in this section applies to:

- Correct setting (See setting instruction)
- No edge distance and spacing influence
- Hollow decks where $b_H \leq 4,2 \cdot b_{st}$
- Hollow decks, classification $\geq C 45/55$
- Concrete $f_{cc} \geq 50 \text{ N/mm}^2$

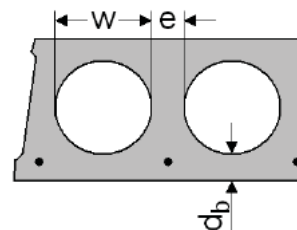

Recommended loads

Anchor size	M6	M8	M10	M6	M8	M10	M6	M8	M10	
Cavity to surface thickness d_b [mm]	≥ 25			≥ 30			≥ 40			
For a single anchor										
Tension F_{rec} [kN]	0,7	0,7	0,9	0,9	0,9	1,2	2,0	2,0	3,0	
For a group of two anchors with a spacing $s \geq 100 \text{ mm}$ and $\leq 200 \text{ mm}$										
Tension F_{rec} [kN]	spacing $s \geq 100 \text{ mm}$	0,9	0,9	1,2	1,2	1,2	1,6	2,5	2,5	4,0
	spacing $s \geq 200 \text{ mm}$	1,1	1,1	1,5	1,5	1,5	2,0	3,3	3,3	5,0
For a group of four anchors with a spacing $s \geq 100 \text{ mm}$ and $\leq 200 \text{ mm}$										
Tension F_{rec} [kN]	spacing $s \geq 100/100 \text{ mm}$	1,2	1,2	1,6	1,6	1,6	2,1	3,5	3,5	5,3
	spacing $s \geq 100/200 \text{ mm}$	1,5	1,5	2,0	2,0	2,0	2,6	4,4	4,4	6,6
	spacing $s \geq 200/200 \text{ mm}$	1,9	1,9	2,5	2,5	2,5	3,3	5,5	5,5	8,3

The given loads are valid for tension load, shear load and all load directions.

Materials

Mechanical properties

Anchor size	M6	M8	M10
Nominal tensile strength f_{uk} [N/mm ²]	Carbon steel	800	500
	Stainless steel	700	700
Admissible bending resistance [Nm]	Carbon steel	7,0	10,7
	Stainless steel	4,9	12,1

Material quality

Part	Material
All parts	HKH (Carbon steel)
	HKH (Stainless steel)

Galvanised to min. 5 μm
Stainless steel A4

Anchor dimension

Anchor size	M6	M8	M10
Thickness of fixture t_{fix} [mm]	≤ 10	≤ 10	≤ 10
Length of the spacer sleeve l_1 [mm]	0	0	0
Length of the part of the sleeve l_{H1} [mm]	10	10	10
Anchor diameter d [mm]	9,8	11,8	13,8
Length of the bolt l [mm]	86	88	93
Length of the part of the sleeve l_h [mm]	55		

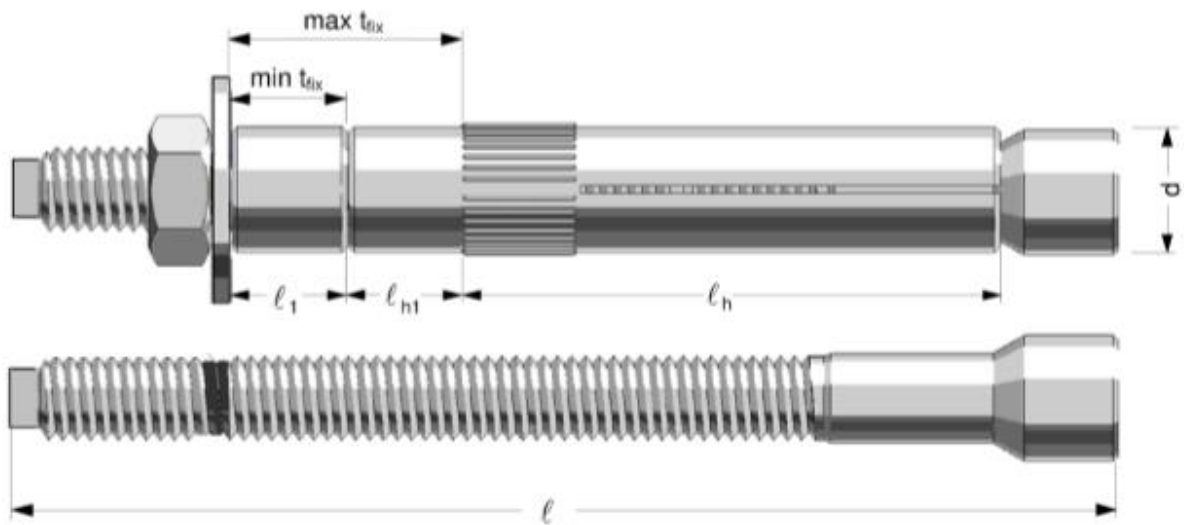

Setting information

Setting details

Anchor size		M6	M8	M10
Diameter of clearance hole in the fixture	$d_f \leq$ [mm]	12	14	16
Embedment depth for HKH	h_s [mm]	55 to 65		
Torque moment	T_{inst} [Nm]	5	10	20
Width across	SW [mm]	10	13	17

Installation equipment

Anchor size	M6	M8	M10
Drill bit	TE-CX-10	TE-CX-12	TE-CX-14
Rotary hammer	TE 6A, TE 6C, TE 6S, TE 15, TE 15-C, TE 18-M		
Setting tools	Torque wrench		
Machine setting tool	available		

Setting parameters

Anchor size		M6	M8	M10
Edge distance ^{a)}	$c \geq$ [mm]	150		
	$c_{min} \geq$ [mm]	100		
Spacing between outer anchors of neighbouring fixation	$a \geq$ [mm]	300		

a) For edge distance < 150 mm the recommended load has to be reduced with $F=0,75 \cdot F_{rec}$.

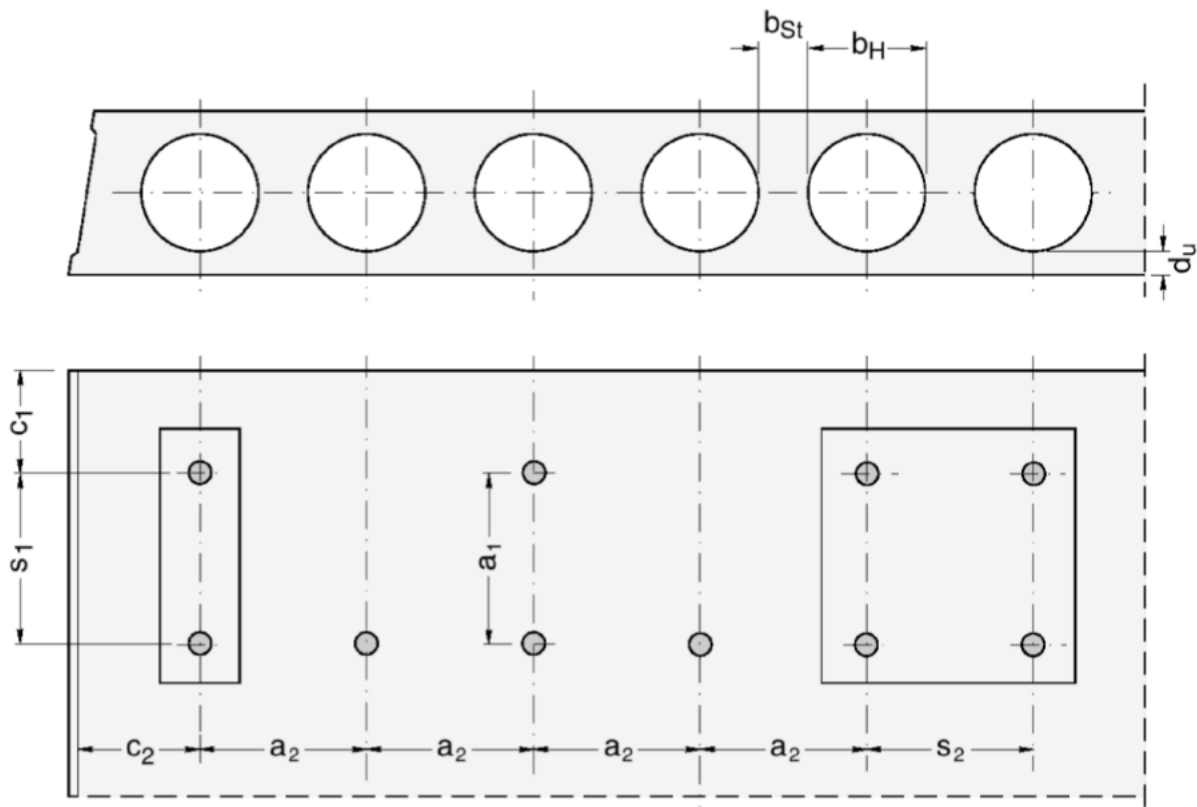

Setting instruction

*For detailed information on installation see instruction for use given with the package of the product.

Setting instruction		
1. Drill the hole 	2. Insert the anchor 	3. Setting mark must be visible

HCA Light duty metal anchors

Economical coil anchor

Anchor version



HCA 5/8"

Benefits

- Re-usable up to 140 times
- High load capacity
- Big washer \varnothing 34 mm
- For temporary external applications

Base material



Concrete
(non-cracked)



Tensile zone

Other information



DIBt
Approval
Reusability

Approvals / certificates

Description	Authority / Laboratory	No. / date of issue
DIBt approval (reusability)	DIBt, Berlin	Z-21.8-2027 / 2014-05-14

Basic loading data

For temporary application:

All data in this section applies to:

- Correct setting (See setting instruction)
- No edge distance and spacing influence
- Base material as specified in the table

For temporary application in standard and fresh concrete < 28 days old:

All data in this section applies to:

- Strength class, $f_{ck,cube} \geq 10 \text{ N/mm}^2$
- Only temporary use
- Screw is reusable, before each usage it must be checked according Hilti instruction for use with the suited tube Hilti HRG
- Design resistance are valid for single anchor only
- Design resistance are valid for all load direction and valid for both cracked and non-cracked concrete
- Minimum base material thickness
- No edge distance and spacing influence

Design resistance for all directions in cracked and non-cracked concrete

Anchor		HCA 5/8" x 90	HCA 5/8" x 130
Length in concrete	$h_{nom} \geq$ [mm]	80	115
For concrete strength $\geq 10 \text{ N/mm}^2$	$F_{Rd}^{(1)}$ [kN]	4	12
For concrete strength $\geq 15 \text{ N/mm}^2$	$F_{Rd}^{(1)}$ [kN]	5	15
For concrete strength $\geq 20 \text{ N/mm}^2$	$F_{Rd}^{(1)}$ [kN]	6	18

Materials

Material quality

Part	Material
Anchor HCA 5/8"	Steel galvanized; $f_{uk} \geq 850 \text{ N/mm}^2$
Coil HCT	Steel galvanized; $350 \text{ N/mm}^2 \leq f_{uk} \leq 800 \text{ N/mm}^2$

Anchor dimensions

Anchor		HCA 5/8" x 90	HCA 5/8" x 130
Length in concrete	$h_{nom} \geq$ [mm]	80	115
Anchor length	l [mm]	90	125
Length of thread	l_s [mm]	51	
Outer diameter	d_t [mm]	15,8	
Core diameter	d_k [mm]	13,1	
Marking for correct installation	h_s [mm]	20	
Cross section	A_s [mm ²]	196,1	

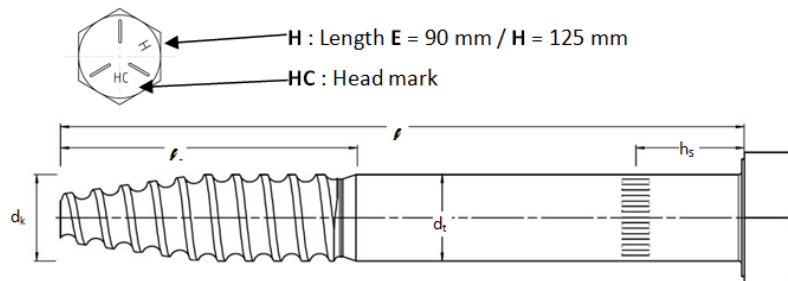

Coil dimensions

Anchor		HCT
Anchor length	l [mm]	29,3
Length of thread	h [mm]	15,6

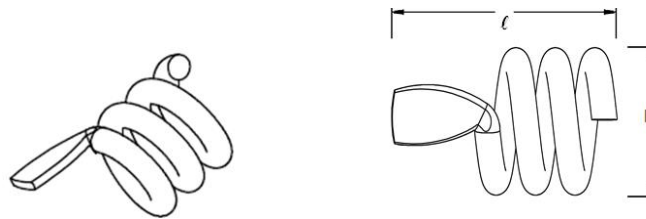

Tube specification

Tube		HRG 16
Inner tube diameter	\varnothing_i [mm]	15,1
Outer tube diameter	\varnothing_e [mm]	20,0
Tube length	L_t [mm]	30,0

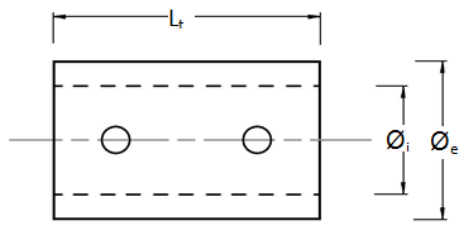

Setting information

Setting details HCA

Anchor			HCA 5/8" x 90	HCA 5/8" x 130
Length in concrete	$h_{nom} \geq$	[mm]	80	115
Nominal diameter of drill bit	d_0	[mm]	16	
Cutting diameter of drill bit	$d_{cut} \leq$	[mm]	16,5	
Diameter of clearance hole in the	d_f	[mm]	18	
Wrench size (H-type)	SW	[mm]	24	
Thickness of fixture	t_{fix}	[mm]	0 ... 10	
Depth of drill hole	$h_1 \geq$	[mm]	95 - t_{fix}	95 - t_{fix}
Torque moment	T_{min}	[Nm]	180	

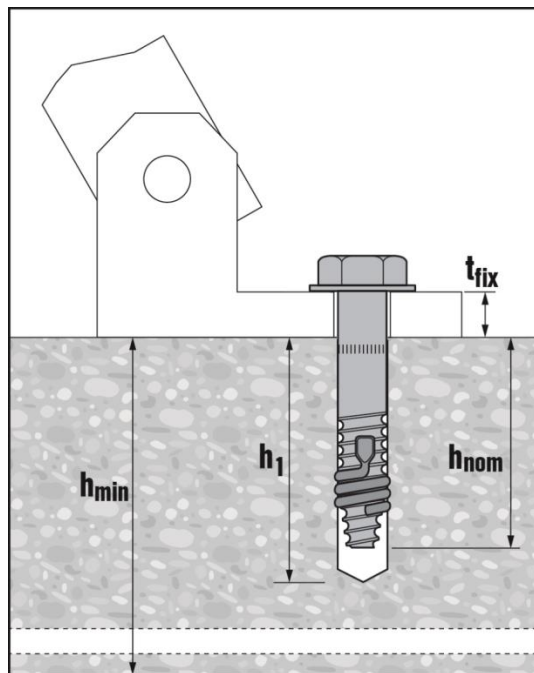

Installation equipment

Anchor	HCA
Rotary hammer	TE 2 – TE 80
Other tools	Hammer, torque wrench, blow out pump

Setting parameters HCA

Anchor			HCA 5/8" x 90	HCA 5/8" x 130
Length in concrete	$h_{nom} \geq$	[mm]	80	115
Min. thickness of concrete member	h_{min}	[mm]	200	200
Min. spacing	s_{min}	[mm]	125	550
Min. edge distance (load direction 1)	$c_{1,min}$	[mm]	150	350
Min. edge distance (load direction 2)	$c_{2,min}$	[mm]	200	500

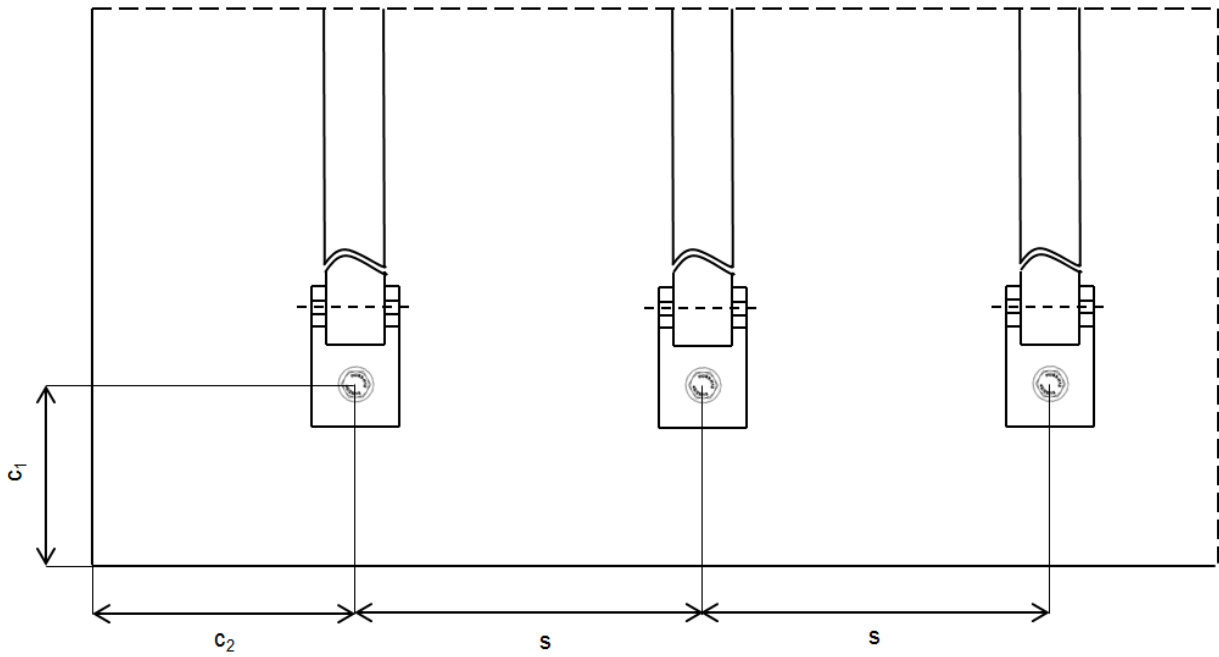

Setting instruction

*For detailed information on installation see instruction for use given with the package of the product.

Setting instructions	
<p>1. Drill the hole</p>	<p>2. Cleaning</p>
<p>3. Position coil</p>	<p>4. Inserting the anchor</p>
<p>5. Attaching the belonging washer</p>	

HHD-S Light duty metal anchors

Economical cavity anchor

Anchor version



HHD-S
(M4-M8)

Benefits

- Metal undercut anchor with metric screw, especially for drywall
- Metal to metal fastening
- Reliable undercut

Base material



Drywall

Basic loading data (for a single anchor)

All data in this section applies to:

- Correct setting (See setting instruction)
- No edge distance and spacing influence
- Base material as specified in the table
- Borehole drilling without hammering

Recommended loads^{a)}

Anchor size		M4	M5	M6	M8
Hollow brick web thickness 20mm	N _{Rd} [kN]	0,1	-	-	-
	V _{Rd} [kN]	0,3	-	-	-
Gypsum board Thickness 10mm	N _{Rd} [kN]	0,2	0,2	0,2	0,2
	V _{Rd} [kN]	0,5	0,5	0,5	0,5
Gypsum board Thickness 12,5mm	N _{Rd} [kN]	0,2	0,2	0,2	0,2
	V _{Rd} [kN]	0,5	0,5	0,5	0,5
Gypsum board Thickness 2x12,5mm	N _{Rd} [kN]	-	0,4	0,3	0,4
	V _{Rd} [kN]	-	1	0,9	1
Fibre reinforced gypsum board Thickness 10mm	N _{Rd} [kN]	0,2	0,3	0,25	0,4
	V _{Rd} [kN]	0,5	0,6	0,8	0,9
Fibre reinforced gypsum board Thickness 12,5mm	N _{Rd} [kN]	0,3	0,5	0,3	0,6
	V _{Rd} [kN]	0,6	1	1	1,2
Fibre reinforced gypsum board Thickness 2x12,5mm	N _{Rd} [kN]	-	0,9	0,8	0,9
	V _{Rd} [kN]	-	1,1	1,8	1,7

a) With overall global safety factor $\gamma = 3$ to the characteristic loads and a partial safety factor of $\gamma = 1,4$ to the design values.

Materials

Material quality

Part	Material
Sleeve	Carbon steel, galvanised
Screw	Carbon steel, galvanised

Setting information

Setting details HHD-S

Anchor		M4x4	M4x6	M4x12	M4x19	M5x8	M5x12	M5x25
Nominal diameter of drill	d_o [mm]	8	8	8	8	10	10	10
Anchor length	l [mm]	20	32	38	45	38	52	65
Anchor neck length	h [mm]	4	6	12,5	19	8	12,5	25
Screw length	$l_s \geq$ [mm]	25	39	45	52	45	58	71
Screw diameter	d [mm]	M4	M4	M4	M4	M5	M5	M5
Panel thickness	$h_{min,max}$ [mm]	3 - 4	6 - 7	10 - 13	18 - 20	6 - 8	11 - 13	23 - 25
Max. fixable thickness for pre-setting	t_{fix} [mm]	15	25	25	25	25	30	30

Setting details HHD-S

Anchor		M6x9	M6x12	M6x24	M6x40	M8x12	M8x24	M8x40
Nominal diameter of drill	d_o [mm]	12	12	12	12	12	12	12
Anchor length	l [mm]	38	52	65	80	54	66	83
Anchor neck length	h [mm]	9	12,5	25	40	12,5	25	40
Screw length	$l_s \geq$ [mm]	45	58	71	88	60	72	90
Screw diameter	d [mm]	M6	M6	M6	M6	M8	M8	M8
Panel thickness	$h_{min,max}$ [mm]	7 - 9	11 - 13	23 - 25	38 - 40	11 - 13	23 - 25	38 - 40
Max. fixable thickness for pre-setting	t_{fix} [mm]	20	30	30	30	30	30	35

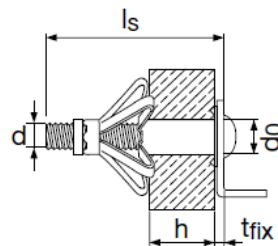

Installation equipment

Anchor	M4	M5	M6	M8
Rotary hammer	TE2 - TE16			
Other tools	Screwdriver, HHD-SZ2 expansion tool			

Setting instruction

*For detailed information on installation see instruction for use given with the package of the product.

Setting instructions

1. Drill hole with drill bit

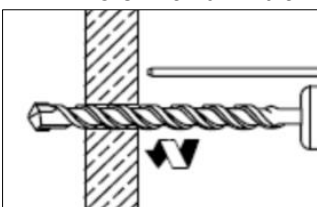

2. Put anchor into setting tool

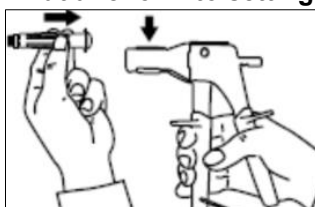

3. Install anchor with setting tool

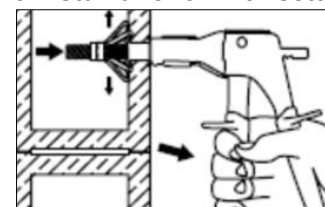

4. Remove screw from anchor and screw in gain with part being fastened attached

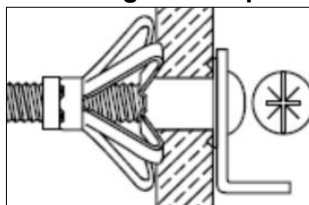
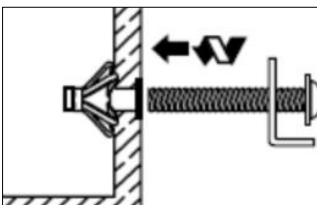

HSP / HFP Light duty metal anchors

Metal drywall anchor

Anchor version

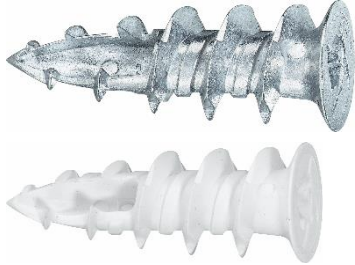

HSP (-S)

HFP (-S)

Benefits

- For light fastenings on drywall panel
- Self-cutting
- Quick setting

Base material



Drywall

Basic loading data

All data in this section applies to:

- Correct setting (See setting instruction)
- No edge distance and spacing influence
- Base material as specified in the table

Recommended loads ^{a)}

Gypsum board thickness		12,5 mm	2 x 12,5 mm
Tensile N _{Rec}	HSP (-S) [kN]	0,06	0,12
	HFP (-S) [kN]	0,06	0,12
Shear V _{Rec}	HSP (-S) [kN]	0,18	0,27
	HFP (-S) [kN]	0,18	0,27

a) With overall global safety factor $\gamma = 3$ to the characteristic load.

Materials

Material quality

Part	Material
HSP (-S)	Polyamide, fibre reinforced
HFP (-S)	Zinc die-casting
Screw	Carbon steel, galvanised to min. 5µm

Setting information

Installation equipment

Anchor	HSP (-S) / HFP (-S)
Rotary hammer	-
Other tools	Screwdriver with D-B PH2 HSP/HFP duo-bit

Setting details HSP (-S) / HFP (-S)

Anchor		HSP (-S)	HFP (-S)
Max fixture thickness	t_{fix}	13	13
Anchor length	l	37	37
Screw length	l_s	19 + t_{fix}	
Screw diameter ϕ	d	4,5	4,5

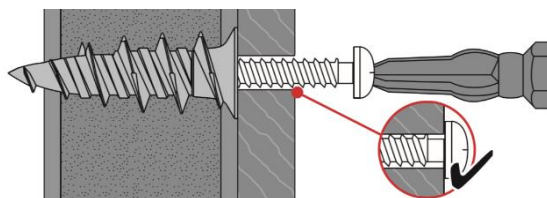
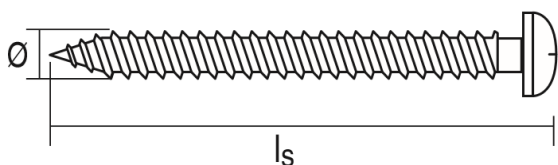

Setting instruction

*For detailed information on installation see instruction for use given with the package of the product.

Setting instructions

Drive in plug

1. Drive in the plug

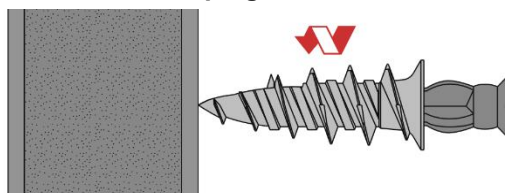

2. Drive in the plug

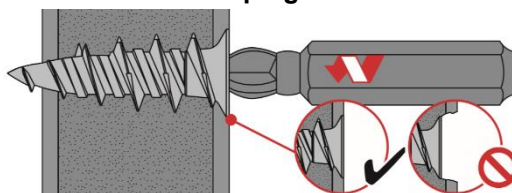

Fasten part and drive in screw

3. Fasten part and drive in screw

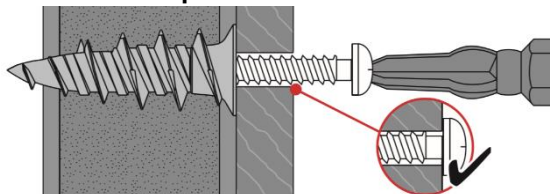

HTB Light duty metal anchors

Economical metal anchor for drywall and hollow wall

Anchor version



HTB
(M5-M6)

Benefits

- Ingenious and strong for hollow base materials
- Convincing simplicity when setting
- Technical superiority with up to 92 mm fixing thickness
- Load carried by strong metal channel and screw

Base material



Drywall

Basic loading data

All data in this section applies to:

- Correct setting (See setting instruction)
- No edge distance and spacing influence
- Base material as specified in the table
- Minimum base material thickness

Characteristic resistance

Anchor size		M5	M6
Gypsum board Thickness 10 mm	N _{Rk} [kN]	0,75	
	V _{Rk} [kN]	0,45	
Gypsum board Thickness 12,5 mm	N _{Rk} [kN]	1,20	
	V _{Rk} [kN]	0,90	
Gypsum board Thickness 2x12,5 mm	N _{Rk} [kN]	2,10	
	V _{Rk} [kN]	0,90	
Fibre reinforced gypsum board Thickness 10 mm	N _{Rk} [kN]	1,20	
	V _{Rk} [kN]	1,80	
Fibre reinforced gypsum board Thickness 12,5 mm	N _{Rk} [kN]	1,80	
	V _{Rk} [kN]	3,00	
Hollow decks Cavity to surface thickness ≥ 30,0 mm	N _{Rk} [kN]	1,50	
	V _{Rk} [kN]	-	
Hollow brick "Parpaing Creux B40"	N _{Rk} [kN]	1,35	
	V _{Rk} [kN]	2,70	

Design resistance

Anchor size			M5	M6
Gypsum board Thickness 10 mm	N_{Rd}	[kN]	0,35	
	V_{Rd}	[kN]	0,21	
Gypsum board Thickness 12,5 mm	N_{Rd}	[kN]	0,56	
	V_{Rd}	[kN]	0,42	
Gypsum board Thickness 2x12,5 mm	N_{Rd}	[kN]	0,98	
	V_{Rd}	[kN]	0,42	
Fibre reinforced gypsum board Thickness 10 mm	N_{Rd}	[kN]	0,56	
	V_{Rd}	[kN]	0,84	
Fibre reinforced gypsum board Thickness 12,5 mm	N_{Rd}	[kN]	0,84	
	V_{Rd}	[kN]	1,40	
Hollow decks Cavity to surface thickness $\geq 30,0$ mm	N_{Rd}	[kN]	0,70	
	V_{Rd}	[kN]	-	
Hollow brick "Parpaing Creux B40"	N_{Rd}	[kN]	0,63	
	V_{Rd}	[kN]	1,26	

Recommended loads^{a)}

Anchor size			M5	M6
Gypsum board Thickness 10 mm	N_{Rec}	[kN]	0,25	
	V_{Rec}	[kN]	0,15	
Gypsum board Thickness 12,5 mm	N_{Rec}	[kN]	0,40	
	V_{Rec}	[kN]	0,30	
Gypsum board Thickness 2x12,5 mm	N_{Rec}	[kN]	0,70	
	V_{Rec}	[kN]	0,30	
Fibre reinforced gypsum board Thickness 10 mm	N_{Rec}	[kN]	0,40	
	V_{Rec}	[kN]	0,60	
Fibre reinforced gypsum board Thickness 12,5 mm	N_{Rec}	[kN]	0,60	
	V_{Rec}	[kN]	1,00	
Hollow decks Cavity to surface thickness $\geq 30,0$ mm	N_{Rec}	[kN]	0,50	
	V_{Rec}	[kN]	-	
Hollow brick "Parpaing Creux B40"	N_{Rec}	[kN]	0,45	
	V_{Rec}	[kN]	0,90	

a) With overall global safety factor $\gamma = 3$ to the characteristic loads and a partial safety factor of $\gamma = 1,4$, to the design values.

Materials

Material quality

Part	Material
Metal channel	Carbon steel galvanized to 5 microns
Cap washer	Polypropylene copolymer
Legs	High impact polystyrene
Screw	Carbon steel galvanized to 3 microns

Setting information

Setting details

Anchor size			M5	M6
Nominal diameter of drill bit	d_o	[mm]	13 - 14	
Thickness of wall and fixture	min	$h + t_{fix}$	10	
	max	$h + t_{fix}$	92	
Minimum space of cavity	l	[mm]	48	
Screw length	l		$12 + h + t_{fix}$	
Screw size	d	[Nm]	M5	M6
Torque moment	T_{inst}	[mm]	3	5

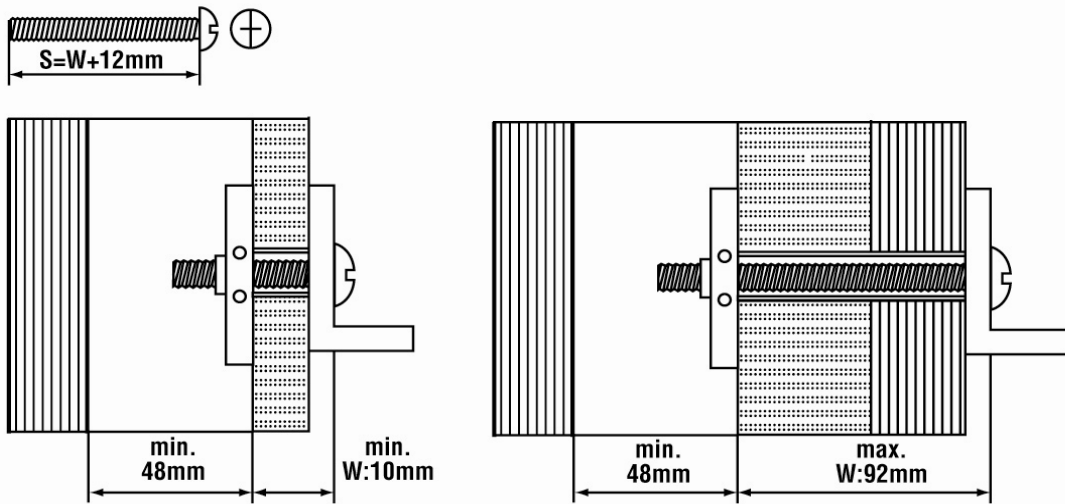

Installation equipment

Anchor size	M5	M6
Rotary hammer	TE 6A, TE 6C, TE 6S, TE 15, TE 15-C, TE 18-M	
Setting tools	Torque wrench	
Machine setting tool	available	

Setting instruction

*For detailed information on installation see instruction for use given with the package of the product.

Setting instruction		
1. Drilling 	2. Inserting anchor in the hole 	3. Adjusting anchor
4. Adjusting anchor 	5. Throw away removable part 	6. Inserting screw with tool



Chemical anchors

Mechanical anchors

Plastic/Light duty metal anchors

Insulation anchors

HIF Insulation fastener

Anchor version



HIF

Benefits

- Especially for soft insulation material
- Plate diameter 90mm is ideal not to sink in the surface
- No slip-on plate must be used
- Drilling, hammering, done
- Speed due to less drilling effort
- With anchors up to 240mm insulation thickness the whole application is covered

Base material



Concrete (non-cracked)

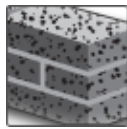

Solid brick

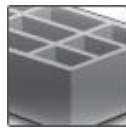

Hollow brick

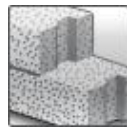

Autoclaved aerated concrete

Other information

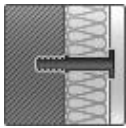

Fastening of insulation at the wall only

Basic loading data (for a single anchor)

All data in this section applies to:

- Correct setting (see setting instruction)
- No edge distance and spacing influence
- Base material as specified in table
- Minimum base material thickness
- Tensile loads only

Recommended loads

Base material		HIF
Concrete \geq C16/20	N_{Rd} [kN]	0,03
Solid clay brick Mz 20 – 1,8 – NF	N_{Rd} [kN]	0,03
Solid sand-lime brick KS 12 – 1,6 – 2DF	N_{Rd} [kN]	0,03
Hollow clay brick ^{c)} Hz 12 – 0,8 – 6DF	N_{Rd} [kN]	0,025 ^{b)}
Hollow sand-lime brick ^{c)} KSL 12 – 1,4 – 3DF	N_{Rd} [kN]	0,03
Autoclaved aerated concrete AAC 4	N_{Rd} [kN]	0,015 ^{b)}

a) Recommended loads N_{rec} are based on an global safety factor $\gamma = 3$ to the characteristic resistance. Design resistance N_{Rd} can be derived by multiplying N_{rec} with a partial safety factor of $\gamma_F = 1,5$.

b) Drilling without hammer action

c) Thickness of web for Hz \geq 18mm, for KSL \geq 25mm

Point thermal transmittance

Base material	Point thermal transmittance χ [W/K]
Insulation	0,000 ^{a)}

a) According EOTA Technical Report TR 025

Fire classification

According to	Classification
DIN 4102	B2
EN 13501-1	E-d2

Service temperature range

	Base material temperature	Maximum long term base material temperature	Maximum short term base material temperature
Temperature range	-40 °C to +40 °C	+24 °C	+40 °C

Maximum short term base material temperature

Short-term elevated base material temperatures are those that occur over brief intervals, e.g. because of diurnal cycling.

Maximum long term base material temperature

Long-term elevated base material temperatures are roughly constant over significant periods of time.

Materials

Material quality

Part	Material
Anchor shaft and anchor plate	Polypropylene

Setting information

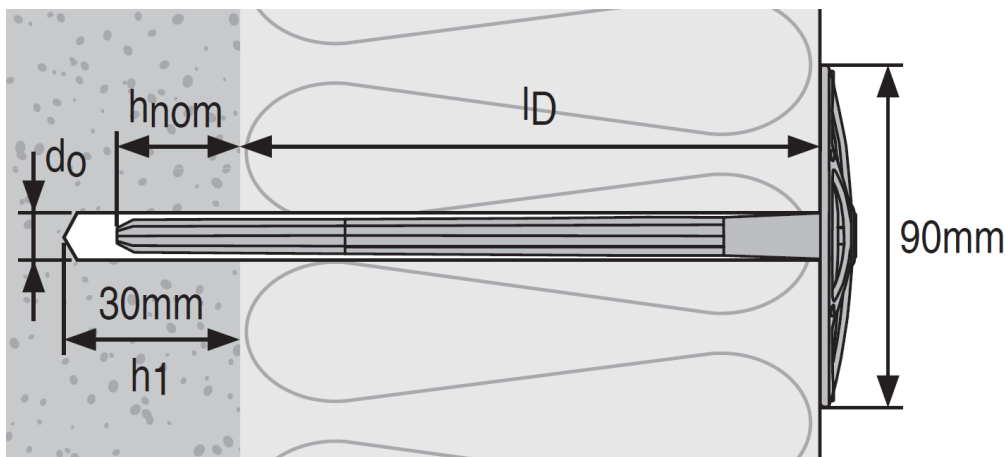

Setting details

HIF	60	80	100	120	140	160	180	200	220	240
Nominal diameter of drill bit d_0 [mm]	8									
Cutting diameter of drill bit $d_{cut} \leq$ [mm]	8,45									
Depth of drill hole $h_1 \geq$ [mm]	$L_a - l_D + 5$ $\geq 30\text{mm}$									
Overall plastic anchor embedment depth in the base material $h_{nom} \geq$ [mm]	25									
Anchor length L_a [mm]	85	105	125	145	165	185	205	225	245	265
Fixture thickness l_D [mm]	40-60	60-80	80-100	100-120	120-140	140-160	160-180	180-200	200-220	220-240
Installation temperature [°C]	0 to +40									
Exposure to UV	≤ 6 weeks									

Installation equipment

Anchor size	HIF
Rotary hammer	Corded: HILTI TE 2 – TE 7 Battery: HILTI TE2-A22, TE4-A22, TE6-A36
Other tools	Hammer

Setting parameters

HIF	60	80	100	120	140	160	180	200	220	240
Minimum base material thickness h_{min} [mm]	100									
Minimum spacing s_{min} [mm]	100									
Minimum edge distance c_{min} [mm]	100									

Setting instruction*

*For detailed information on installation see instruction for use given with the package of the product.

Setting instructions

1. Drill hole with drill bit

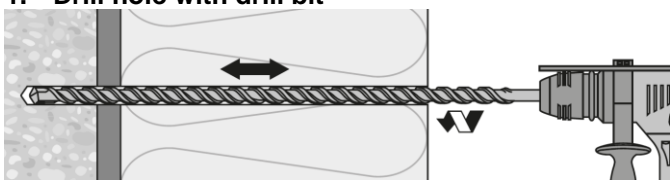

2. Tap fastener with a hammer

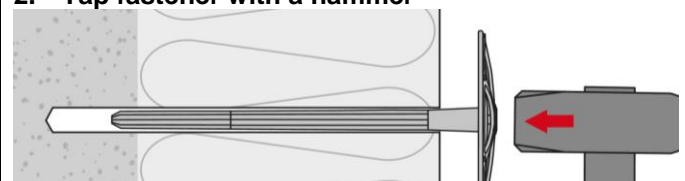

3. Check correct setting

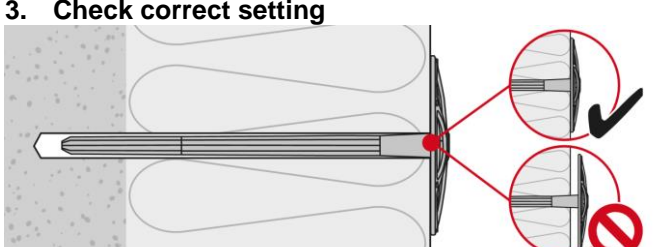

HTH Insulation fastener

Anchor version



HTH

Benefits

- Fastening in all base materials of category A, B, C, D and E
- Setting tool for fast and safe application
- Lowest heat transmission (chi-value up to 0.000 W/K)
- One anchor size fits all insulation thickness

Base material



Concrete (non-cracked)

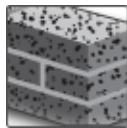

Solid brick

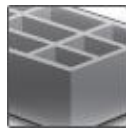

Hollow brick

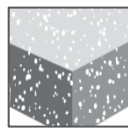

Lightweight Aggregate concrete

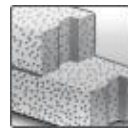

Autoclavated Aerated concrete

Other information

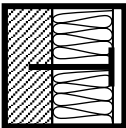

Fastening of insulation at the wall only



European Technical Assessment



CE conformity

Approvals/Certificates

Description	Authority / Laboratory	No. / date of issue
European Technical Assessment ^{a)}	DIBt, Berlin	ETA-15/0464 / 2018-01-11
Application in External Thermal Insulation Composite Systems with Rendering ^{a)}	DIBt, Berlin	Z-21.2-2047 / 2018-04-13

a) Unless otherwise stated, all data given in this section are according to named documents

Basic loading data (for a single anchor)

All data in this section applies to:

- Correct setting (see setting instruction)
- No edge distance and spacing influence
- Base material as specified in table
- Minimum base material thickness
- Transmission of wind suction loads only

Characteristic resistance

Base material	Use cat. ^{d)}		HTH
Concrete ≥ C12/15	A	N _{Rk} [kN]	1,2
Thin concrete members (e.g. weather resistant skins of external wall panels) C16/20 – C 50/60	A	N _{Rk} [kN]	1,2
Solid clay brick Mz 20/2,0	B	N _{Rk} [kN]	1,2
Solid sand-lime brick KS 20/2,0	B	N _{Rk} [kN]	1,2
Vertically perforated clay brick Hz 12/1,2	C	N _{Rk} [kN]	1,2 ^{a)}
Vertically perforated clay brick Hz 12/0,8	C	N _{Rk} [kN]	0,6 ^{b)}
Vertically perforated sand-lime brick KSL 12/1,4	C	N _{Rk} [kN]	1,2 ^{c)}
Lightweight Aggregate Concrete ≥ LAC2 (raw density ≥ 0,9 kg/dm ³)	D	N _{Rk} [kN]	0,6
Lightweight Aggregate Concrete ≥ LAC4 (raw density ≥ 0,9 kg/dm ³)	D	N _{Rk} [kN]	1,2
Autoclaved aerated concrete ≥ PP4 (raw density ≥ 0,5 kg/dm ³)	E	N _{Rk} [kN]	0,9

a) The value applies only for outer web thickness ≥ 12 mm, rotary drilling only

b) The value applies only for outer web thickness ≥ 9 mm, rotary drilling only

c) The value applies only for outer web thickness ≥ 23 mm, rotary drilling only

d) Different installation parameters for use categories A, B, C and use categories D, E and thin concrete members to be considered

Design resistance

Design resistance was calculated according to equation:

$$N_{Rd} = \frac{N_{Rk}}{\gamma_M} \text{ with } \gamma_M = 2,0 \text{ (safety factor for base material)}$$

Base material	Use cat. ^{d)}		HTH
Concrete ≥ C12/15	A	N _{Rd} [kN]	0,6
Thin concrete members (e.g. weather resistant skins of external wall panels) C16/20 – C 50/60	A	N _{Rd} [kN]	0,6
Solid clay brick Mz 20/2,0	B	N _{Rd} [kN]	0,6
Solid sand-lime brick KS 20/2,0	B	N _{Rd} [kN]	0,6
Vertically perforated clay brick Hz 12/1,2	C	N _{Rd} [kN]	0,6 ^{a)}
Vertically perforated clay brick Hz 12/0,8	C	N _{Rk} [kN]	0,3 ^{b)}
Vertically perforated sand-lime brick KSL 12/1,4	C	N _{Rd} [kN]	0,6 ^{c)}
Lightweight Aggregate Concrete ≥ LAC2 (raw density ≥ 0,9 kg/dm ³)	D	N _{Rd} [kN]	0,3
Lightweight Aggregate Concrete ≥ LAC4 (raw density ≥ 0,9 kg/dm ³)	D	N _{Rd} [kN]	0,6
Autoclaved aerated concrete ≥ PP4 (raw density ≥ 0,5 kg/dm ³)	E	N _{Rd} [kN]	0,45

a) The value applies only for outer web thickness ≥ 12 mm, rotary drilling only

b) The value applies only for outer web thickness ≥ 9 mm, rotary drilling only

c) The value applies only for outer web thickness ≥ 23 mm, rotary drilling only

d) Different installation parameters for use categories A, B, C and use categories D, E and thin concrete members to be considered

Recommended loads

Recommended load was calculated according to equation:

$$N_{Rd} = \frac{N_{Rd}}{\gamma_F} \text{ with } \gamma_F = 1,5 \text{ (safety factor for wind)}$$

Base material	Use cat. ^{d)}		HTH
Concrete ≥ C12/15	A	N _{Rd} [kN]	0,4
Thin concrete members (e.g. weather resistant skins of external wall panels) C16/20 – C 50/60	A	N _{Rd} [kN]	0,4
Solid clay brick Mz 20/2,0	B	N _{Rd} [kN]	0,4
Solid sand-lime brick KS 20/2,0	B	N _{Rd} [kN]	0,4
Vertically perforated clay brick Hlz 12/1,2	C	N _{Rd} [kN]	0,4 ^{a)}
Vertically perforated clay brick Hlz 12/0,8	C	N _{Rk} [kN]	0,2 ^{b)}
Vertically perforated sand-lime brick KSL 12/1,4	C	N _{Rd} [kN]	0,4 ^{c)}
Lighweight Aggregate Concrete ≥ LAC2 (raw density ≥ 0,9 kg/dm ³)	D	N _{Rd} [kN]	0,2
Lighweight Aggregate Concrete ≥ LAC4 (raw density ≥ 0,9 kg/dm ³)	D	N _{Rd} [kN]	0,4
Autoclaved aerated concrete ≥ PP4 (raw density ≥ 0,5 kg/dm ³)	E	N _{Rd} [kN]	0,3

a) The value applies only for outer web thickness ≥ 12 mm, rotary drilling only

b) The value applies only for outer web thickness ≥ 9 mm, rotary drilling only

c) The value applies only for outer web thickness ≥ 23 mm, rotary drilling only

d) Different installation parameters for use categories A, B, C and use categories D, E and thin concrete members to be considered

Insulation Materials

Insulation material and provider	Specifying document	Referenced document for anchor design	Design provisions ^{a)}	Anchor design
EPS with designation key T2 L2 W2 S2 P4 BS50 DS(70)5-DS(N)2 a) TR80 raw density 15-20 kg/m ³ ; b) TR100 raw density 15-30 kg/m ³	DIN EN 13163	Z-21.2-2047 April 13 th 2018, DIBt	ETICS fixed with anchor and supplementary adhesive Panels 100mm to 360mm thick	see next pages ^{b)}
Coverrock, Coverrock II and Coverrock 036 by Deutsche Rockwool Mineralwoll GmbH	Z-33.4-1571, October 14 th 2016, DIBt			
Sillatherm WVP 1-035 by SAINT-GOBAIN ISOVER G+H AG	Z-33.4-1081, Oct. 14 th 2016, DIBt			
Mineral wool FKD-MAX C1/C2 by Knauf Insulation GmbH	Anwendungs-dokument ^{b)}	Anwendungs-dokument ^{c)}	ETICS fixed with anchor and supplementary adhesive Panels 100mm to 200mm thick	see next pages
Mineral wool FKD-S C2 by Knauf Insulation GmbH	ÖNorm B6000:2017	B6400-1, September 2017		Systemklasse 3
Mineral wool PAROC FAS 3cc by PAROC GmbH				
Mineral wool ROCKWOOL PT A 036 by ROCKWOOL Handelsgesellschaft m.b.H.				

- a) Design provisions of this table refer to the referenced documents for anchor design. National provisions of other countries might be different and must be considered.
- b) In Germany: Design provisions of German ETICS-approval Z-33.43-xxxx must be considered, too. The less unfavourable design of Z-21.2-2047 and Z-33.43-xxxx is applicable.
- c) Anwendungsdokument Mineralwolle-Dämmstoff nach EN 16262 für die Verwendung in Wärmedämmverbundsystemen (WDVS), Knauf Insulation Putzträgerplatte FKD-MAX C1, Knauf Insulation Putzträgerplatte FKD-MAX C2, Knauf Insulation GmbH, November 2017

In absence of national provisions, HTH can be used for ETICS with mineral wool if the following provision are kept:

- minimum 4 anchors/m²
- only ETICS fixed with anchors and supplementary adhesive
- only ETICS that hold an ETA or National approval
- Mineral wool of TR5 or greater
- Mineral wool of 100mm to 300mm thickness
- Rendering weight ≤ 48 kg/m²
- Characteristic pull-through resistance of the mineral wool in combination with HTH has to be determined by tests
- Design of anchor number/m² must be done based on characteristic pull-through resistance and pull-out resistance by an engineer experienced in anchor design

Number of anchors based on design wind resistance $w_{ed}=w_e \cdot \gamma_F$ for different insulation panels and base material categories A, B, C, D, E ^{a) b) c)}

Design load of wind w_{ed} [kN/m ²] ^{e)}				Number of anchors per m ²	Anchor pattern ^{f)}
EPS TR80	EPS TR100	Coverrock, Coverrock II and Coverrock 036	Sillatherm WVP 1-035		
Panel size: 1000mm x 500mm		Panel size: 800mm x 625mm			
≤ 1,2	≤ 1,3	≤ 0,6	≤ 0,3	4	
≤ 1,7	≤ 1,9	≤ 0,8	≤ 0,4	6	
≤ 2,2	≤ 2,4	≤ 1,1	≤ 0,6	8	
≤ 2,6	≤ 2,9	≤ 1,2	≤ 0,7	10	
≤ 3,0	≤ 3,3	≤ 1,4	-	12	
-	-	≤ 1,5	-	14	

- a) The design of anchorages must be carried out in accordance to ETAG 014 and ETAG 004 under the responsibility of an engineer experienced in anchorages.
- b) The table considers a safety factor for the base material of $\gamma_{M,BM}=2,0$, for EPS $\gamma_{M,EPS}=1,5$, and for mineral wool $\gamma_{M,MW}=2,0$.
- c) All base materials given in tables before are covered. In case that the characteristic resistance is determined by job site tests, the number of anchors is determined by the greater number in the table and $n = w_{ed}/(N_{rk,job\ site}/\gamma_{M,BM})$, where $N_{rk,job\ site}$ =characteristic resistance determined by job site tests and $\gamma_{M,BM}=2,0$ (in absence of national safety factors). The number n shall be rounded upwards to an integer number.
- d) DIBt letter November 13th, 2017 lays out that ETICS anchor approvals do cover wind resistances only. Effects caused by ETICS' weight and hygrothermal influences are not considered. In every case the ETICS approval must be considered.
- e) $w_{ed}=w_e \times \gamma_F$ where w_e =characteristic external wind suction according EN 1991-1-4:2005-04 and national appendixes. Safety factor for wind $\gamma_F=1,5$.
- f) The application of the indicated anchor pattern pre-assumes that the anchors are set with a distance ≥ 150 mm to the edge of the panels

Chemical anchors

Mechanical anchors

Plastic/Light duty metal anchors

Insulation anchors

Number of anchors based on design wind loads w_e for different insulation panels and base material categories A, B, C, D, E a) b) c) d)

wind load w_{ed} [kN/m ²] e)				Number of anchors per m ²	Anchor pattern ^{f)}
EPS TR80	EPS TR100	Coverrock, Coverrock II and Coverrock 036	Sillatherm WVP 1-035		
Panel size: 1000mm x 500mm		Panel size: 800mm x 625mm			
≤ 0,80	≤ 0,87	≤ 0,40	≤ 0,20	4	
≤ 1,13	≤ 1,27	≤ 0,53	≤ 0,27	6	
≤ 1,47	≤ 1,60	≤ 0,73	≤ 0,40	8	
≤ 1,73	≤ 1,93	≤ 0,80	≤ 0,47	10	
≤ 2,00	≤ 2,20	≤ 0,93	-	12	
-	-	≤ 1,00	-	14	

- a) The design of anchorages must be carried out in accordance to ETAG 014 and ETAG 004 under the responsibility of an engineer experienced in anchorages.
- b) The table considers a safety factor for the base material of $\gamma_{M,BM}=2,0$, for EPS $\gamma_{M,EPS}=1,5$, for mineral wool $\gamma_{M,MW}=2,0$ and for wind action $\gamma_F=1,5$
- c) All base materials given in tables before are covered. In case that the characteristic resistance is determined by job site tests, the number of anchors is determined by the greater number in the table and $n = w_e / (N_{rk,job\ site} / (\gamma_{M,BM} \times \gamma_F))$, where $N_{rk,job\ site}$ =characteristic resistance determined by job site tests, $\gamma_{M,BM}=2,0$ and $\gamma_F=1,50$ (in absence of national safety factors). The number n shall be rounded upwards to an integer number.
- d) DIBt letter November 13th, 2017 lays out that ETICS anchor approvals do cover wind resistances only. Effects caused by ETICS' weight and hygrothermal influences are not considered. In every case the ETICS approval must be considered.
- e) w_e =characteristic external wind suction according EN 1991-1-4:2005-04 and national annexes
- f) The application of the indicated anchor pattern pre-assumes that the anchors are set with a distance ≥ 150 mm to the edge of the panels

Number of anchors based on wind loads w_e for FKD-MAX panels, size 1200mm x 400mm and base material categories A, B, C, D, E ^{a) b) c) d)}

wind load w_e [kN/m ²] ^{e)}	Number of anchors per m ²	Anchor pattern ^{f)}
FKD-MAX		
Panel size: 1200mm x 400mm		
$\leq 0,50$	6	
$\leq 0,60$	7	
$\leq 0,70$	8	
$\leq 0,80$	9	
$\leq 0,90$	10	
$\leq 1,0$	11	
$\leq 1,12$	12	

- a) The design of anchorages must be carried out in accordance to ETAG 014 and ETAG 004 under the responsibility of an engineer experienced in anchorages.
- b) The table considers a safety factor for the base material of $\gamma_{M,BM}=2,0$, for EPS $\gamma_{M,EPS}=1,5$, for mineral wool $\gamma_{M,MW}=2,0$ and for wind action $\gamma_F=1,5$
- c) All base materials given in tables before are covered. In case that the characteristic resistance is determined by job site tests, the number of anchors is determined by the greater number in the table and $n = w_e / (N_{rk,job\ site} / (\gamma_{M,BM} \times \gamma_F))$, where $N_{rk,job\ site}$ = characteristic resistance determined by job site tests, $\gamma_{M,BM}=2,0$ and $\gamma_F=1,50$ (in absence of national safety factors). The number n shall be rounded upwards to an integer number.
- d) DIBt letter November 13th, 2017 lays out that ETICS anchor approvals do cover wind resistances only. Effects caused by ETICS' weight and hygrothermal influences are not considered. In every case the ETICS approval must be considered.
- e) w_e = characteristic external wind suction according EN 1991-1-4:2005-04 and national annexes
- f) The application of the indicated anchor pattern pre-assumes that the anchors are set with a distance ≥ 150 mm to the edge of the panels

Point Thermal Transmittance

Anchor size		HTH 8x125	HTH 8x155
Point thermal transmittance χ	[W/K]	0,001 ($t_{fix}= 80$ mm, 100 mm $\leq h_D \leq 150$ mm)	0,000 ($t_{fix}= 80$ mm, 150 mm $< h_D \leq 360$ mm)

Plate stiffness and plate capacity ^{a) b)}

Anchor size		HTH 8x125	HTH 8x155
Capacity of plate	[kN]	1,80	
Plate stiffness	[kN/mm]	0,70	

- a) Test report DET 15-008, HILTI corporation, Schaan (LI), 13.04.2015, testing in accordance with EOTA-TR026, 06.2007
- b) The data are related to the performance of the helix-shaped insulation holder of HTH. The naming plate stiffness and plate capacity were kept because that is the common nomenclature.

Chemical anchors
Mechanical anchors
Plastic/Light duty metal anchors
Insulation anchors

Hilti HTH ETICS anchors may be applied in the temperature range given below.

Service temperature range

	Base material temperature	Maximum long term base material temperature	Maximum short term base material temperature
Temperature range	0 °C to +40 °C	+24 °C	+40 °C

Maximum short term base material temperature

Short-term elevated base material temperatures are those that occur over brief intervals, e.g. as a result of diurnal cycling.

Maximum long term base material temperature

Long-term elevated base material temperatures are roughly constant over significant periods of time.

Materials

Material quality

Part	Material
Anchor sleeve	Polypropylene, black
Expansion screw	Steel, galvanized
Plug	EPS
PU-Foam	Polyurethane, thermal conductivity $\leq 0,045$ W/(mK)

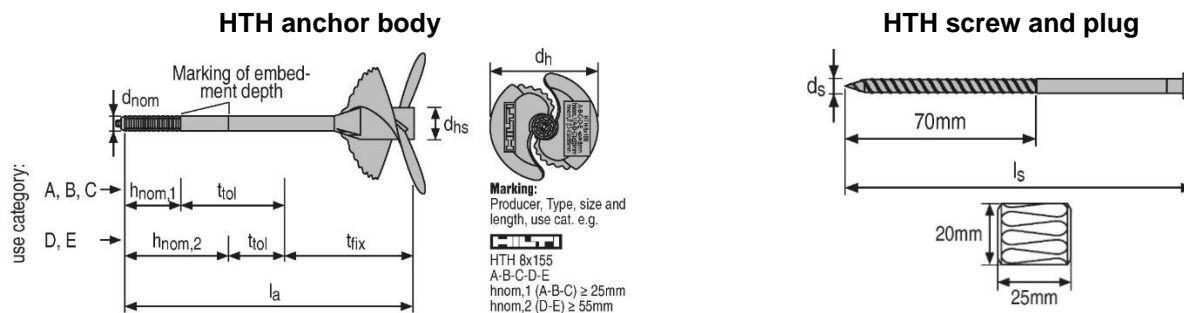

Anchor size

		HTH 8x125	HTH 8x155
Diameter of sleeve	d_{nom} [mm]	8	
Length of sleeve	l_a [mm]	125	125
Diameter of helix center	d_{hs} [mm]	17	
Diameter of helix	d_h [mm]	75	
Screw diameter	d_s [mm]	5,35	
Length of screw	l_s [mm]	94	94

Anchor designations

		HTH
Anchor sleeve	Top of helix	Producer: HILTI Anchor type: HTH Size and length [mm]: e.g. 8x155 Use categories (base materials): A-B-C-D-E Overall embedment depth in use categories A, B and C: $h_{nom,1}$ (A-B-C) \geq 25mm Overall embedment depth in use categories D and E: $h_{nom,2}$ (D-E) \geq 55mm
	Sleeve	Embedment depth $h_{nom,1}$ =end of corrugated part of sleeve (25mm) Embedment depth $h_{nom,2}$ =circumferential line at sleeve (55mm)

Setting information

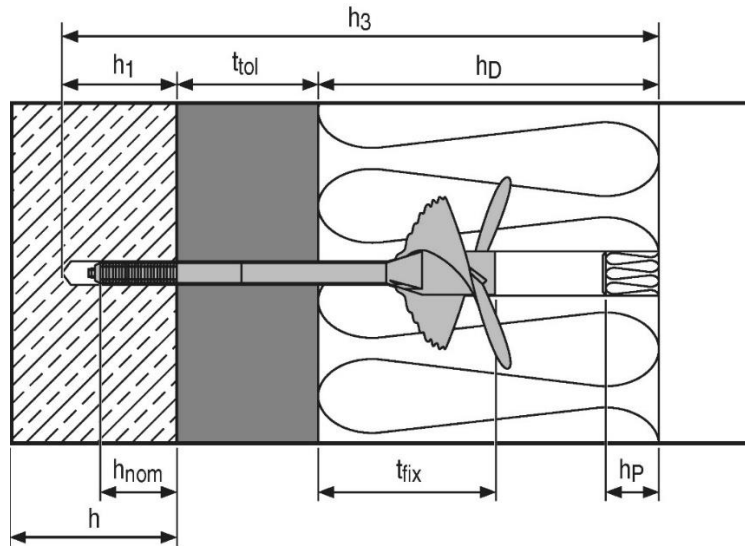

The anchor shall not be exposed to UV-radiation for more than 6 weeks.

Concrete and solid masonry (use category A, B)

		HTH 8x125	HTH 8x155
Nominal diameter of drill bit	d_o [mm]	8	
Cutting diameter of drill bit	d_{cut} [mm]	8,45	
Minimum depth of drilled hole to the deepest point	h_1 [mm]	45	
Overall plastic anchor embedment depth in the base material	$h_{nom,1}$ [mm]	25	
Thickness of fixture	t_{fix} [mm]	80	80
Thickness of equalizing layer for compensation of tolerances or non-loadbearing layer	$t_{tol,min}$ [mm]	0	0
	$t_{tol,max}$ [mm]	20	20
Total length of borehole	h_3 [mm]	h_D+65	h_D+95

Thin concrete members (e.g. weather resistant skins or external wall panels) and hollow masonry (use category C)

		HTH 8x125	HTH 8x155
Nominal diameter of drill bit	d_o [mm]	8	
Cutting diameter of drill bit	d_{cut} [mm]	8,45	
Minimum depth of drilled hole to the deepest point	h_1 [mm]	45	
Overall plastic anchor embedment depth in the base material	$h_{nom,1}$ [mm]	25	
Thickness of fixture	t_{fix} [mm]	80	80
Thickness of equalizing layer for compensation of tolerances or non-loadbearing layer	$t_{tol,min}$ [mm]	0	0
	$t_{tol,max}$ [mm]	20	20
Total length of borehole	h_3 [mm]	h_D+65	h_D+95

a) $t_{tol,min}$ may be lower if the anchor performance is tested on site.

Thin concrete members (e.g. weather resistant skins or external wall panels) and hollow masonry (use category C)

		HTH 8x125	HTH 8x155
Nominal diameter of drill bit	d_o [mm]	-	8
Cutting diameter of drill bit	d_{cut} [mm]	-	8,45
Minimum depth of drilled hole to the deepest point	h_1 [mm]	-	75
Overall plastic anchor embedment depth in the base material	$h_{nom,1}$ [mm]	-	55
Thickness of fixture	t_{fix} [mm]	-	80
Thickness of equalizing layer for compensation of tolerances or non-loadbearing layer	$t_{tol,min}$ [mm]	-	0
	$t_{tol,max}$ [mm]	-	20
Total length of borehole	h_3 [mm]	-	h_D+95

Installation equipment

Anchor	HTH
Rotary hammer	TE 2 – TE 7
Installation	Screw driver SFH 22-A or SF 10W or similar (n=370-600 rpm) Setting tool HTH-SW 1 ($h_D=100-200mm$), HTH-SW 2 ($h_D=200-360mm$) Setting tool D8-SW 1 ($h_D=100-200mm$), D8-SW 2 ($h_D=200-360mm$)

HTH Setting tools

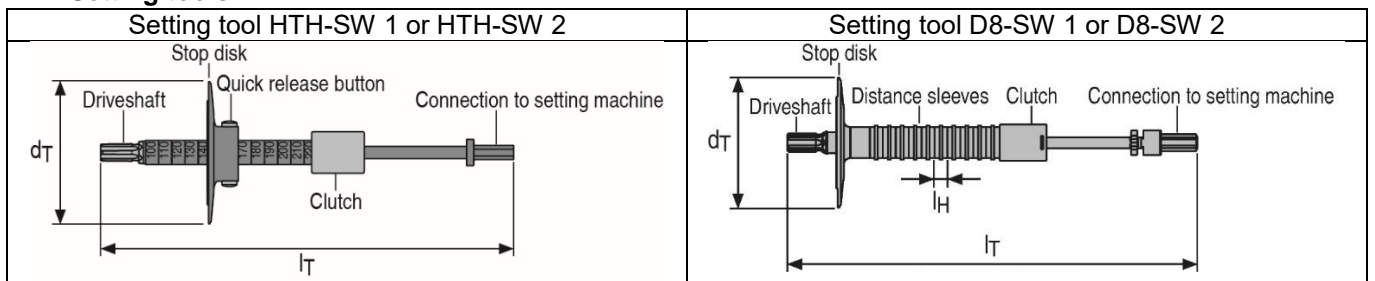

Setting tool HTH-SW 1 and HTH-SW 2

Setting tool			HTH-SW 1	HTH-SW 2
Diameter of disk	d_T	[mm]	100	
Length of the tool	l_T	[mm]	310	477
Applicable insulation thickness	$h_{D,min}$	[mm]	100	200
	increment	[mm]	10	
	$h_{D,max}$	[mm]	200	360

Setting tool D8-SW 1 and D8-SW 2

Setting tool			D8-SW 1	D8-SW 2
Diameter of disk	d_T	[mm]	100	
Length of the tool	l_T	[mm]	310	477
Length of distance sleeves (insulation thickness increment)	l_H	[mm]	10	
Applicable insulation thickness	$h_{D,min}$	[mm]	100	200
	$h_{D,max}$	[mm]	200	360

Minimum edge distance, minimum spacing and minimum base material thickness

			HTH
Minimum base material thickness	Concrete, masonry, lightweight aggregate concrete and autoclaved aerated concrete	h_{min} [mm]	100
	Thin concrete members (e.g. weather resistant skins of external wall panels)		40
Minimum spacing		s_{min} [mm]	100
Minimum edge distance		c_{min} [mm]	100

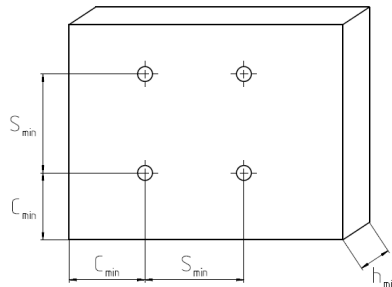

Setting instruction*

*For detailed information on installation see instruction for use given with the package of the product.

Setting instructions	
<p>1. Drill hole with drill bit</p>	<p>2. Set insulation thickness</p>
<p>3. Prepare the setting tool click!</p>	<p>4. Insert fastener by hand</p>
<p>5. Insert the helix with setting tool</p>	
<p>6. Cover the whole with the plug or mortar</p>	

Chemical anchors

Mechanical anchors

Plastic/Light duty metal anchors

Insulation anchors

HTR-P / HTR-M Insulation fastener

Anchor version



HTR-P
HTR-M

Benefits

- Best in class setting comfort and surface finish
- Productivity increase
- Heat transmission class 0 W/K due to screw made of high performance plastic
- Fastening in all base materials of category A, B, C, D and E

Base material



Concrete

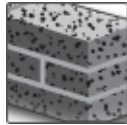

Solid brick

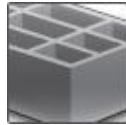

Hollow brick

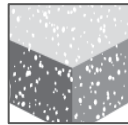

Lightweight
Aggregate
concrete

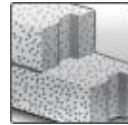

Autoclaved
Aerated
concrete

Other information

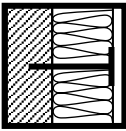

Fastening of
insulation at the
wall only



European
Technical
Assessment



CE
conformity

Approvals/Certificates

Description	Authority / Laboratory	No. / date of issue
European technical assessment ^{a)}	ZAG, Ljubljana	ETA-16/0116 / 2018-03-28

a) All data given in this section are - if not otherwise indicated - in accordance ETA-16/0116, issue 2018-03-28

Basic loading data for short term acting loads e.g. wind (for a single anchor)

All data in this section applies to:

- Correct setting (see setting instruction)
- No edge distance and spacing influence
- Base material as specified in table
- Minimum base material thickness
- Transmission of wind suction loads only
- Redundant fastening in non-cracked concrete
- Anchor and its plate is not exposed to UV-radiation for more than 6 weeks

Characteristic resistance (short term acting loads)

Base material			HTR-P / HTR-M
Concrete C12/15	N_{Rk}	[kN]	1,00
Concrete 16/20 – C50/60	N_{Rk}	[kN]	1,50
Thin concrete members (e.g. weather resistant skins of external wall panels) C16/20 – C50/60	N_{Rk}	[kN]	1,20
Solid clay brick, Mz 12/2,0	N_{Rk}	[kN]	1,20
Solid sand-lime brick, KS 12/1,8	N_{Rk}	[kN]	1,50
Vertically perforated clay brick, Hlz 20/1,6	N_{Rk}	[kN]	1,20 ^{a)}
Vertically perforated clay brick, Hlz 12/0,8	N_{Rk}	[kN]	0,70 ^{b)}
Vertically perforated sand-lime brick, KSL 12/1,4	N_{Rk}	[kN]	1,20 ^{a)}
Lightweight Aggregate Concrete \geq LAC4, (raw density \geq 1,4 kg/dm ³)	N_{Rk}	[kN]	0,90
Autoclaved aerated concrete \geq PP4 (raw density \geq 0,5 kg/dm ³)	N_{Rk}	[kN]	0,50 / 0,75 ^{c)}

a) The value applies only for outer web thickness \geq 20 mm, rotary drilling only

b) The value applies only for outer web thickness \geq 11 mm, rotary drilling only

c) The greater resistance is applicable only with alternative (greater) embedment depth $h_{nom}=50$ mm

Design resistance (short term acting loads)

Base material			HTR-P / HTR-M
Concrete C12/15	N_{Rd}	[kN]	0,50
Concrete 16/20 – C50/60	N_{Rd}	[kN]	0,75
Thin concrete members (e.g. weather resistant skins of external wall panels) C16/20 – C50/60	N_{Rd}	[kN]	0,60
Solid clay brick, Mz 12/2,0	N_{Rd}	[kN]	0,60
Solid sand-lime brick, KS 12/1,8	N_{Rd}	[kN]	0,75
Vertically perforated clay brick, Hlz 20/1,6	N_{Rd}	[kN]	0,60 ^{a)}
Vertically perforated clay brick, Hlz 12/0,8	N_{Rd}	[kN]	0,35 ^{b)}
Vertically perforated sand-lime brick, KSL 12/1,4	N_{Rd}	[kN]	0,60 ^{a)}
Lightweight Aggregate Concrete \geq LAC4, (raw density \geq 1,4 kg/dm ³)	N_{Rd}	[kN]	0,45
Autoclaved aerated concrete \geq PP4 (raw density \geq 0,5 kg/dm ³)	N_{Rd}	[kN]	0,25 / 0,375 ^{c)}

a) The value applies only for outer web thickness \geq 20 mm, rotary drilling only

b) The value applies only for outer web thickness \geq 11 mm, rotary drilling only

c) The greater resistance is applicable only with alternative (greater) embedment depth $h_{nom}=50$ mm

Recommended loads (short term acting loads)

Base material			HTR-P / HTR-M
Concrete C12/15	N_{Rd}	[kN]	0,33
Concrete 16/20 – C50/60	N_{Rd}	[kN]	0,50
Thin concrete members (e.g. weather resistant skins of external wall panels) C16/20 – C50/60	N_{Rd}	[kN]	0,40
Solid clay brick, Mz 12/2,0	N_{Rd}	[kN]	0,40
Solid sand-lime brick, KS 12/1,8	N_{Rd}	[kN]	0,50
Vertically perforated clay brick, Hlz 20/1,6	N_{Rd}	[kN]	0,40 ^{a)}
Vertically perforated clay brick, Hlz 12/0,8	N_{Rd}	[kN]	0,23 ^{b)}
Vertically perforated sand-lime brick, KSL 12/1,4	N_{Rd}	[kN]	0,40 ^{a)}
Lightweight Aggregate Concrete \geq LAC4, (raw density \geq 1,4 kg/dm ³)	N_{Rd}	[kN]	0,30
Autoclaved aerated concrete \geq PP4 (raw density \geq 0,5 kg/dm ³)	N_{Rd}	[kN]	0,167 / 0,25 ^{c)}

a) The value applies only for outer web thickness \geq 20 mm, rotary drilling only

b) The value applies only for outer web thickness \geq 11 mm, rotary drilling only

c) The greater resistance is applicable only with alternative (greater) embedment depth $h_{nom}=50$ mm

Recommended pull-through (short term acting) loads in different insulation materials ^{a)}

Insulation	Thickness [mm]	Plate-Ø [mm]	Pull-through load [kN]
Expanded polystyrene EPS	60 - 119	≥ 60	0,15
Expanded polystyrene EPS	120 - 260	≥ 60	0,20
Mineral wool, type HD	60 - 260	≥ 60	0,15
Mineral wool, type WV	60 - 260	≥ 90	0,15 ^{b)}
Mineralwolle, type lamella	60 - 260	≥ 140	0,167 ^{c)}

a) This technical data are not covered by ETA-16/0116. They are based on an HILTI-internal assessment of test data. Recommended values can be used in case that the insulation material to be fastened is not covered by a European Technical Assessment (ETA) or any national approval document. If the ETICS to be fastened is covered by an ETA or any national approval document, the given pull-through resistance in the ETA or national approval document is applicable. The design of anchorages has to be carried out in accordance to EAD 330196-01-0604 and ETAG 004 or EAD 040083-00-0404 or applicable national regulation under the responsibility of an engineer experienced in anchorages.

b) HILTI slip-on plate HDT 90 must be used

c) HILTI slip-on plate HDT 140 must be used

Basic provisions for dead loads on the bottom side of ceilings (for a single anchor)
All data in this section applies to

- Correct setting (see setting instruction)
- No edge distance and spacing influence
- Base material as specified in the table
- Minimum base material thickness
- Quasi-static permanent loads only
- Redundant fastening in non-cracked and cracked concrete
- Anchor and its plate is not exposed to UV-radiation for more than 6 weeks

Note: Pull-through resistance of panel and its bending resistance shall be proven by panel manufacturer or any other person experienced in the design of such panels. Drawings of fixing positions shall be provided to the operator. Each panel shall be fixed with 4 anchors at least.

Recommended number of anchors for fixing panels to ceilings w/o consideration of wind loads^{a)}:

Specific panels weight	Number of anchors per m ²
≤ 29 kg/m ²	4
≤ 43 kg/m ²	6
≤ 57 kg/m ²	8
≤ 71 kg/m ²	10

a) This technical data are not covered by ETA-16/0116. They are based on an HILTI-internal assessment of test data. A safety factor for dead load $\gamma_F=1,35$ and a safety factor $\gamma_M=1,80$ for material is considered.

Point thermal transmittance

	Insulation thickness [mm]	Point thermal transmittance χ [W/K]
HTR-P / HTR-M	60 - 260	0,000

Plate Stiffness and plate capacity

	Plate diameter [mm]	Capacity of plate [kN]	Plate stiffness [kN/mm]
HTR-P / HTR-M	Ø 60	1,4	0,6

Service temperature range

	Base material temperature	Maximum long term base material temperature	Maximum short term base material temperature
Temperature range I	0 °C to +40 °C	+24 °C	+40 °C

Maximum short-term base material temperature

Short-term elevated base material temperatures are those that occur over brief intervals, e.g. because of diurnal cycling.

Maximum long-term base material temperature

Long-term elevated base material temperatures are roughly constant over significant periods of time.

Materials, dimensions, designations

Part		Material
Anchor sleeve		Polyethylene, black
Anchor plate		Polypropylene, red
Expansion plastic screw	HTR-P	Polyamide, glass fiber reinforced 50%, black
Composite screw	HTR-M	Expansion element: steel, galvanized Shank: polyamide, glass fiber reinforced, black
Slip-on plate	HDT 90	Polypropylene, glass fiber reinforced, white
Slip-on plate	HDT 140	Polyamide, glass fiber reinforced, white

HTR-P

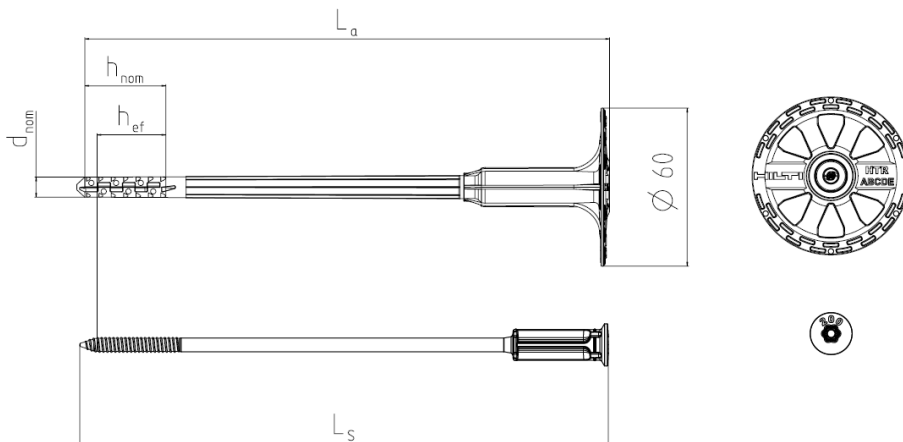

HTR-M

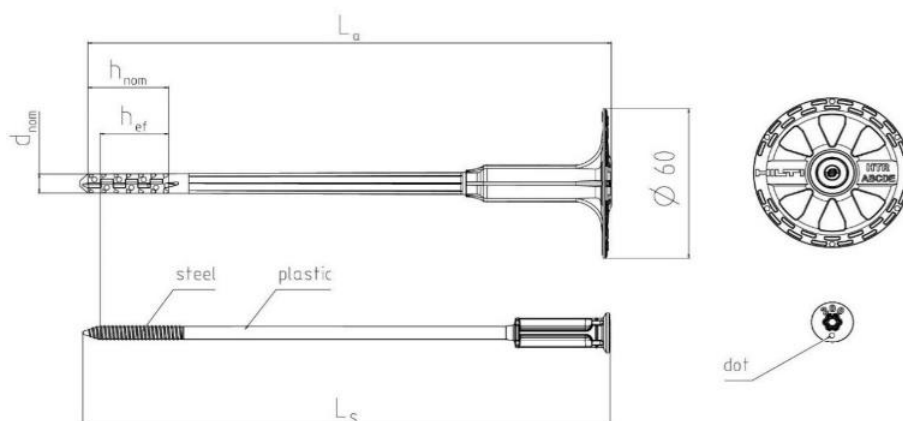

Anchor dimensions

		HTR-P / HTR-M
Diameter of sleeve	d_{nom} [mm]	8
Minimum length of anchor body	$L_{a,min}$ [mm]	100
Maximum length of anchor body	$L_{a,max}$ [mm]	300
Minimum length of screw	$L_{S,min}$ [mm]	101
Maximum length of screw	$L_{S,max}$ [mm]	301

Anchor designations

		HTR-P / HTR-M
Expansion screw	Top of head	HTR-P: Anchor length L_a (e.g. "300") HTR-M: Anchor length L_a (e.g. "300" and a dot ●)
Plate	Top of plate	Producer: HILTI
		Anchor type: HTR
	Bottom side of plate	Base material categories: A, B, C, D, E Nominal embedment depth: $h_{nom}=30$ mm for base material categories A, B, C, D, E Nominal drill bit diameter: 8 mm

Setting information

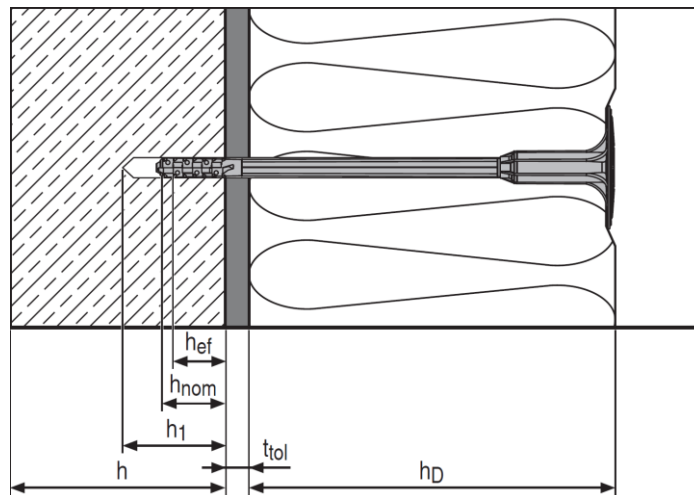

Setting details:

		HTR-P / HTR-M	
		Base material category A, B, C, D and E	Base material category E ^{a)}
Nominal diameter of drill bit	d_o [mm]	8	
Cutting diameter of drill bit	$d_{cut} \leq$ [mm]	8,45	
Depth of drill hole	$h_1 \geq$ [mm]	40	40
Effective anchorage depth	h_{ef} [mm]	25	25
Overall embedment depth	h_{nom} [mm]	30	30
Thickness of insulation	h_D [mm]	60 to 260	60 to 260
Maximum thickness of tolerance layer	$t_{tol,max}$ [mm]	$L_a - h_{nom} - h_D^{b)}$	
Installation temperature	[°C]	0 to +40	
Exposure to UV-radiation		≤ 6 weeks	

a) In base material category E (autoclaved aerated concrete PP4) an alternative embedment depth $h_{nom}=50$ mm with greater resistance is available

b) L_a ... Anchor length, h_{nom} ... Overall embedment depth, h_D ... Thickness of insulation

Example:

HTR-P 8x300 or HTR-M 8x300: $L_a = 300$ mm; $h_{nom} = 30$ mm; $h_D = 260$ mm

$t_{tol,max} = 300$ mm - 30 mm - 260 mm = 10 mm

Installation equipment

	HTR-P / HTR-M
Rotary hammer	Corded: HILTI TE 2 – TE 7 Battery: HILTI TE2-A22, TE4-A22, TE6-A36
Installation	Electrical screw driver e.g. HILTI SF 2-A + TX30 The use of setting tool SW-HTR is recommended

Minimum edge distance, minimum spacing and minimum base material thickness

	HTR-P / HTR-M	
Minimum base material thickness	h_{min} [mm]	100 ^{a)}
Minimum spacing	s_{min} [mm]	100
Minimum edge distance	c_{min} [mm]	100

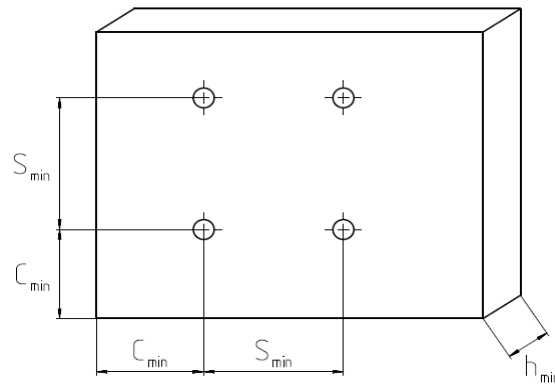

a) Except for thin concrete members (e.g. weather resistant skins of external walls) with $h_{min}=40mm$). The belonging characteristic resistance must be considered.

Setting instruction*

*For detailed information on installation see instruction for use given with the package of the product.

Setting instructions	
<p>1. Drill hole with drill bit</p>	<p>2. Insert the fastener by hand</p>
<p>3. Make sure that anchor's plate is in touch with insulation panel's surface</p>	<p>4. Use screw driver with setting tool to insert the fastener</p>
<p>5. Check correct setting</p>	

T-Save HTS-P / HTS-M Insulation fastener

Anchor version



T-Save HTS-P
T-Save HTS-M

Benefits

- Fastening in all base materials of category A, B, C, D and E
- Easy and fast to install
- Best insulation surface finish
- Heat transmission class 0,000 W/K

Base material



Concrete (non-cracked)

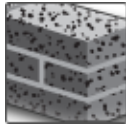

Solid brick

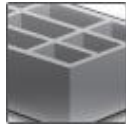

Hollow brick

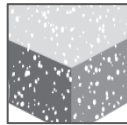

Lightweight Aggregate concrete

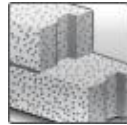

Autoclaved aerated concrete

Other information

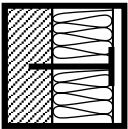

Fastening of insulation



European Technical Assessment



CE conformity

Approvals/Certificates

Description	Authority / Laboratory	No. / date of issue
European technical assessment ^{a)}	ZAG, Ljubljana	ETA-14/0400 / 2017-06-23

Basic loading data for short term acting loads e.g. wind (for a single anchor)

All data in this section applies to:

- Correct setting (see setting instruction)
- No edge distance and spacing influence
- Redundant fastenings in the base materials as specified in the tables
- Minimum base material thickness or greater
- Transmission of wind suction loads only
- Anchor and its plate is not exposed to UV-radiation for more than 6 weeks

Characteristic resistance (short term acting load)

Base material		T-Save HTS-P / T-Save HTS-M
Concrete \geq C12/15	N_{Rk} [kN]	0,9
Solid clay brick Mz 12/2,0	N_{Rk} [kN]	0,9
Solid sand-lime brick KS 12/1,8	N_{Rk} [kN]	0,9
Vertically perforated clay brick Hz 20/1,6	N_{Rk} [kN]	0,75 ^{a)}
Vertically perforated sand-lime brick KSL 12/1,4	N_{Rk} [kN]	0,75 ^{a)}
Lightweight Aggregate Concrete \geq LAC4 (raw density \geq 1,4 kg/dm ³)	N_{Rk} [kN]	0,60
Autoclaved aerated concrete \geq PP4 (raw density \geq 0,5 kg/dm ³)	N_{Rk} [kN]	0,40

a) The value applies only for outer web thickness \geq 20 mm, rotary drilling only

Design resistance (short term acting load)

Base material		T-Save HTS-P / T-Save HTS-M
Concrete \geq C12/15	N_{Rd} [kN]	0,45
Solid clay brick Mz 12/2,0	N_{Rd} [kN]	0,45
Solid sand-lime brick KS 12/1,8	N_{Rd} [kN]	0,45
Vertically perforated clay brick Hz 20/1,6	N_{Rd} [kN]	0,375 ^{a)}
Vertically perforated sand-lime brick KSL 12/1,4	N_{Rd} [kN]	0,375 ^{a)}
Lightweight Aggregate Concrete \geq LAC4 (raw density \geq 1,4 kg/dm ³)	N_{Rd} [kN]	0,30
Autoclaved aerated concrete \geq PP4 (raw density \geq 0,5 kg/dm ³)	N_{Rd} [kN]	0,20

a) The value applies only for outer web thickness \geq 20 mm, rotary drilling only

Recommended loads (short term acting load)

Base material		T-Save HTS-P / T-Save HTS-M
Concrete \geq C12/15	N_{Rec} [kN]	0,3
Solid clay brick Mz 12/2,0	N_{Rec} [kN]	0,3
Solid sand-lime brick KS 12/1,8	N_{Rec} [kN]	0,3
Vertically perforated clay brick Hz 20/1,6	N_{Rec} [kN]	0,25 ^{a)}
Vertically perforated sand-lime brick KSL 12/1,4	N_{Rec} [kN]	0,25 ^{a)}
Lightweight Aggregate Concrete \geq LAC4 (raw density \geq 1,4 kg/dm ³)	N_{Rec} [kN]	0,20
Autoclaved aerated concrete \geq PP4 (raw density \geq 0,5 kg/dm ³)	N_{Rec} [kN]	0,13

a) The value applies only for outer web thickness \geq 20 mm, rotary drilling only

Recommended (short term) pull-through loads in different insulation materials ^{a)}

Base material	Thickness [mm]	Plate-Ø [mm]	Pull-through load [kN]
Expanded polystyrene EPS	60-100	≥ 60	0,15
Expanded polystyrene EPS	120-260	≥ 60	0,20
Mineral wool, type HD	60-260	≥ 60	0,15
Mineral wool, type WV	60-260	≥ 90	0,15 ^{b)}
Mineral wool, type lamella	60-260	≥ 140	0,167 ^{c)}

a) Recommended values in case that the insulation material to be fixed is not covered by a European Technical Assessment (ETA) or any national approval document. If the ETICS to be fixed is covered by an ETA or any national approval document, the given pull-through resistance in the ETA or national approval document is applicable. The design of anchorages must be carried out in accordance to EAD330196-01-0604 and ETAG 004 or applicable national regulation under the responsibility of an engineer experienced in anchorages.

b) HILTI slip-on plate HDT 90 must be used

c) HILTI slip-on plate HDT 140 must be used

Basic provisions for fixing insulation on the bottom side of ceilings

All data in this section applies to

- Correct setting (see setting instruction)
- No edge distance and spacing influence
- Redundant fastening in non-cracked concrete
- Minimum base material thickness or greater
- Transmission of quasi-static permanent loads only
- Anchor and its plate is not exposed to UV-radiation for more than 6 weeks

Note: Each panel shall be supported by 4 anchors at least e.g. by T-joint fixing.

Recommended number of anchors for fixing panels to ceilings w/o consideration of wind load^{a)}:

Specific panels weight	Number of anchors per m ²
EPS (≤30 kg/m ³ , TR≥100 kPa, 60mm≤thickness≤260)	4
Mineral wool (≤120 kg/m ³ , TR≥3.5 kPa, 60mm≤thickness≤120mm)	
Mineral wool (≤150 kg/m ³ , TR≥3.5 kPa, 60mm≤thickness≤100mm)	
Mineral wool (≤200 kg/m ³ , TR≥3.5 kPa, 60mm≤thickness≤70mm)	5

a) These technical data are not covered by ETA-14/0400. They are based on a HILTI-internal assessment. A safety factor for dead load $\gamma_F=1,35$, a safety factor $\gamma_{M, EPS}=1,50$, a safety factor $\gamma_{M, Mineralwool}=2,00$ for material is considered.

Point thermal transmittance

Base material	Thickness [mm]	Point thermal transmittance χ [W/K]
Insulation	60-260	0,000

Plate Stiffness and plate capacity

Base material	Thickness [mm]	Capacity of plate [kN]	Plate stiffness [kN/mm]
Insulation	60-260	1,4	0,6

Service temperature range

	Base material temperature	Maximum long term base material temperature	Maximum short term base material temperature
Temperature range	0 °C to +40 °C	+24 °C	+40 °C

Maximum short term base material temperature

Short-term elevated base material temperatures are those that occur over brief intervals, e.g. because of diurnal cycling.

Maximum long term base material temperature

Long-term elevated base material temperatures are roughly constant over significant periods of time.

Materials

Material quality

Part		Material
Anchor sleeve	HTS-P and HTS-M	Polyethylene, black
Anchor plate	HTS-P und HTS-M	Polypropylene, white
Expansion pin	HTS-P	Polyamide, fiber reinforced 50%, black
Expansion pin	HTS-M	Expansion element: steel Shaft: polyamide, fiber reinforced 50%, black
Slip-on plate	HDT 90	Polypropylene, fiber reinforced, white
Slip-on plate	HDT 140	Polyamide, fiber reinforced, white

T-Save HTS-P

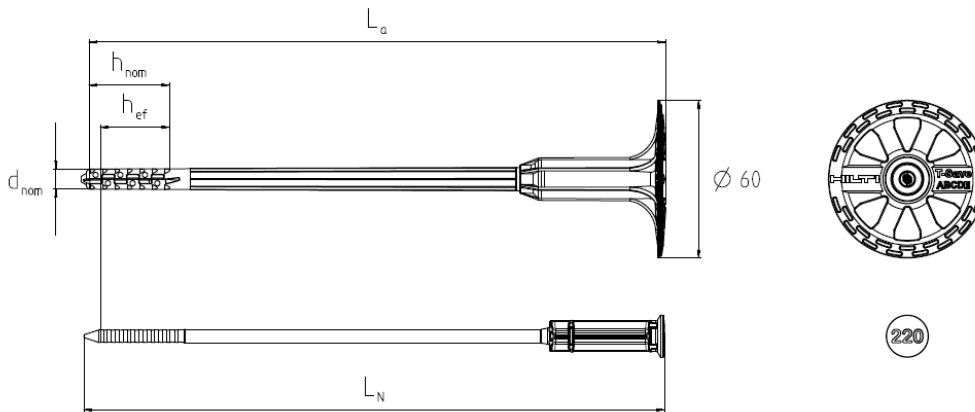

T-Save HTS-M

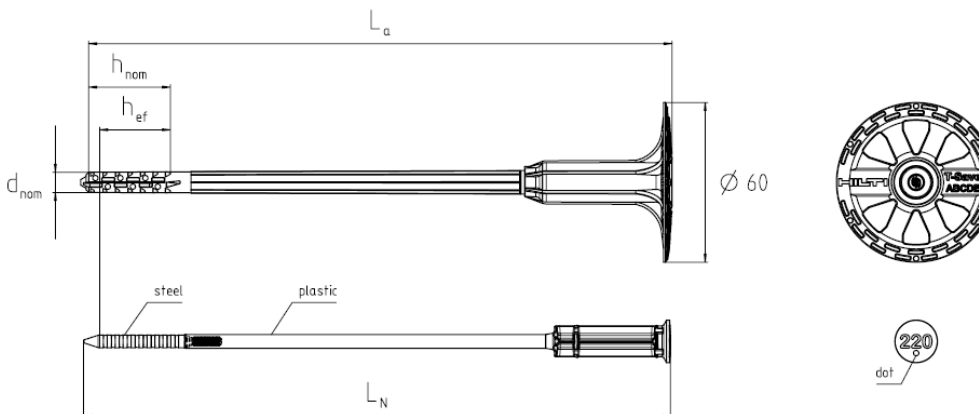

Anchor dimensions

		T-Save HTS-P / T-Save HTS-M
Diameter of sleeve	d_{nom} [mm]	8
Minimum length of anchor body	$L_{a,min}$ [mm]	100
Maximum length of anchor body	$L_{a,max}$ [mm]	300
Minimum length of pin	$L_{N,min}$ [mm]	101
Maximum length of pin	$L_{N,max}$ [mm]	301

Anchor designations

		T-Save HTS-P / T-Save HTS-M
Expansion screw	Top of head	T-Save HTS-P: Anchor length L_a (e.g. "220") T-Save HTS-M: Anchor length L_a (e.g. "220" and a dot •)
Plate	Top of plate	Producer: HILTI
		Anchor type: T-Save
	Bottom side of plate	Base material categories: A, B, C, D, E Nominal embedment depth: $h_{nom}=30$ mm for base material categories A, B, C, D, E Nominal drill bit diameter: 8 mm

Setting information

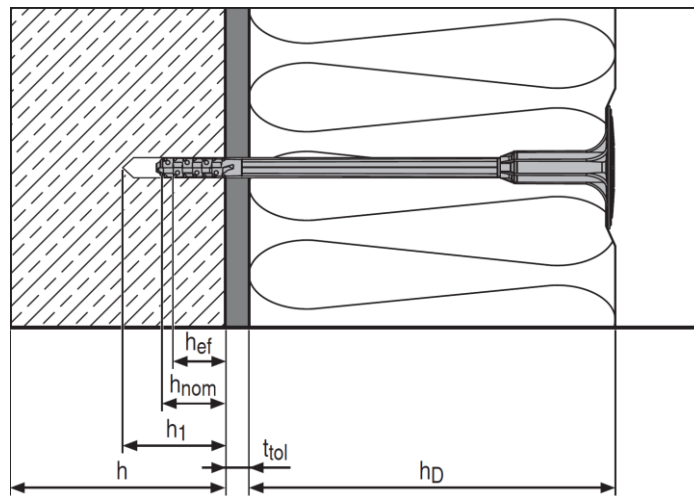

Setting details:

		T-Save HTS-P / T-Save HTS-M
Nominal diameter of drill bit	d_o [mm]	8
Cutting diameter of drill bit	$d_{cut} \leq$ [mm]	8,45
Depth of drill hole	$h_1 \geq$ [mm]	40
Effective anchorage depth	h_{ef} [mm]	25
Overall embedment depth	h_{nom} [mm]	30
Thickness of insulation	h_D [mm]	60 to 260
Maximum thickness of tolerance layer	$t_{tol,max}$ [mm]	$L_a - h_{nom} - h_D^{a)}$
Installation temperature	[°C]	0 to +40
UV exposure		≤ 6 weeks

- a) L_a ... Anchor length, h_{nom} ... Overall embedment depth, h_D ... Thickness of insulation
 Example:
 T-Save HTS 8x220-P: $L_a = 220$ mm; $h_{nom} = 30$ mm; $h_D = 180$ mm
 $t_{tol,max} = 220 - 30 - 180 = 10$ mm

Installation equipment

Anchor size	T-Save HTS-P / T-Save HTS-M
Rotary hammer	Corded: HILTI TE 2 – TE 7 Battery: HILTI TE2-A22, TE4-A22, TE6-A36
Installation	Hammer 500g to 1500g

Minimum edge distance, minimum spacing and minimum base material thickness

		T-Save HTS-P / T-Save HTS-M
Minimum base material thickness	h_{min} [mm]	100
Minimum spacing	S_{min} [mm]	100
Minimum edge distance	C_{min} [mm]	100

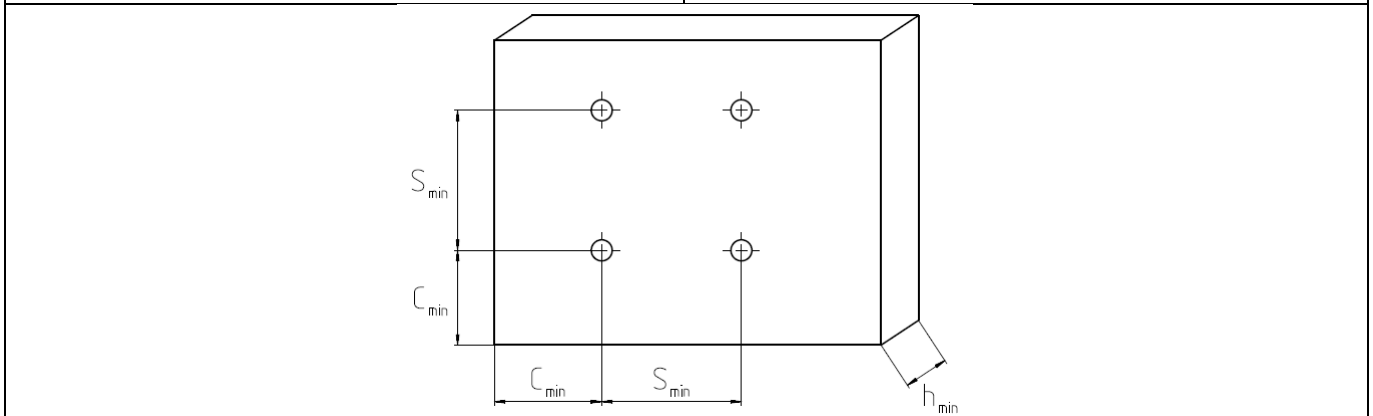

Setting instruction*

*For detailed information on installation see instruction for use given with the package of the product.

Setting instructions	
1. Drill hole with drill bit 	2. Insert the fastener by hand
3. Tap fastener with a hammer 	4. Check correct setting

IDP Insulation fastener

Anchor version



IDP

Benefits

- for insulation up to 15 cm
- simple setting

Base material



Concrete
(non-cracked)

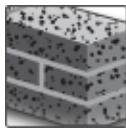

Solid brick

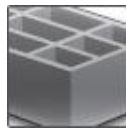

Hollow brick

Other information

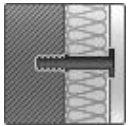

Fastening of
insulation at the
wall only

Basic loading data (for a single anchor)

All data in this section applies to:

- Correct setting (see setting instruction)
- No edge distance and spacing influence
- Base material as specified in table
- Minimum base material thickness
- Loads shall be reduced and number of fasteners shall be increased if temperature sustains above 40°C

Recommended loads ^{a)}

Base material			IDP
Concrete \geq C16/20	N_{rec}	[kN]	0,14
Solid clay brick Mz 20 – 1,8 – NF	N_{rec}	[kN]	0,14
Solid sand-lime brick KS 12 – 1,6 – 2DF	N_{rec}	[kN]	0,14
Hollow clay brick Hz 12 – 0,8 – 6DF	N_{rec}	[kN]	0,04 ^{b)}
Hollow sand-lime brick KSL 12 – 1,4 – 3DF	N_{rec}	[kN]	0,04

a) With overall global safety factor $\gamma = 5$ to the characteristic loads and a partial safety factor of $\gamma = 1,4$ to the design values.

b) Drilling without hammering

Materials

Material quality

Part	Material
Anchor with plate	Polypropylene

Setting information

Setting details

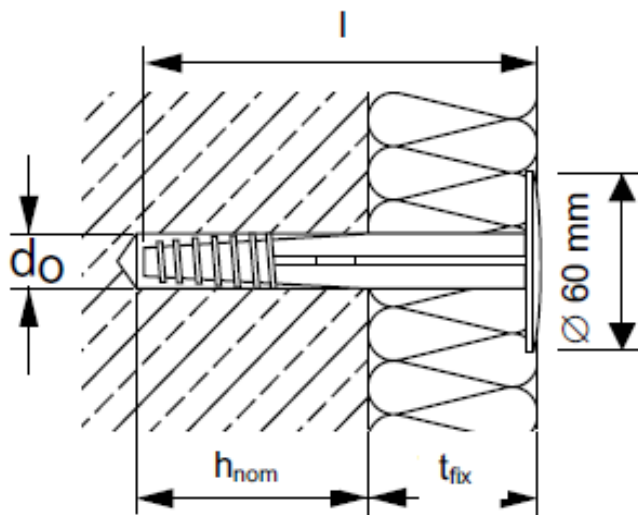

Anchor size		0/2	2/4	4/6	6/8	8/10	10/12	13/15
Nominal diameter	d_0 [mm]	8						
Cutting diameter of drill bit	$d_{cut} \leq$ [mm]	8,45						
Depth of drill hole	$h_1 \geq$ [mm]	$l - t_{fix} + 10\text{mm} \geq 40\text{mm}$						
Nominal anchorage depth	h_{nom} [mm]	25						
Anchor length	l [mm]	50	70	90	110	130	150	180
Maximum thickness of fixture	t_{fix} [mm]	20	40	60	80	100	120	150
Installation temperature	[°C]	0 up to 40						

Installation equipment

Anchor size	IDP
Rotary hammer	Corded: HILTI TE 2 – TE 7 Battery: HILTI TE2-A22, TE4-A22, TE6-A36
Other tools	Hammer

Setting instruction*

*For detailed information on installation see instruction for use given with the package of the product.

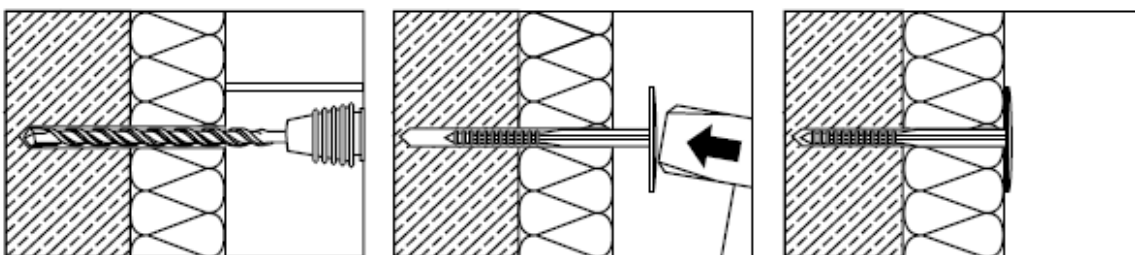

Drill hole with drill bit.

Tap in fastener with a hammer.

Acknowledgements

To Luis Pombo, Martina Rajniakova, Michael Roessle, Miriam Campillo and Zhiar Azad: without them, the release of this FTM would have not been possible.



Hilti Corporation
9494 Schaan, Liechtenstein

Edition February 2019 / 403736

www.facebook.com/hiltigroup
www.hilti.com